

**SOKKIA**

**iX-1000 series**  
**iX-500 series**

**intelligence X-ellence Station**

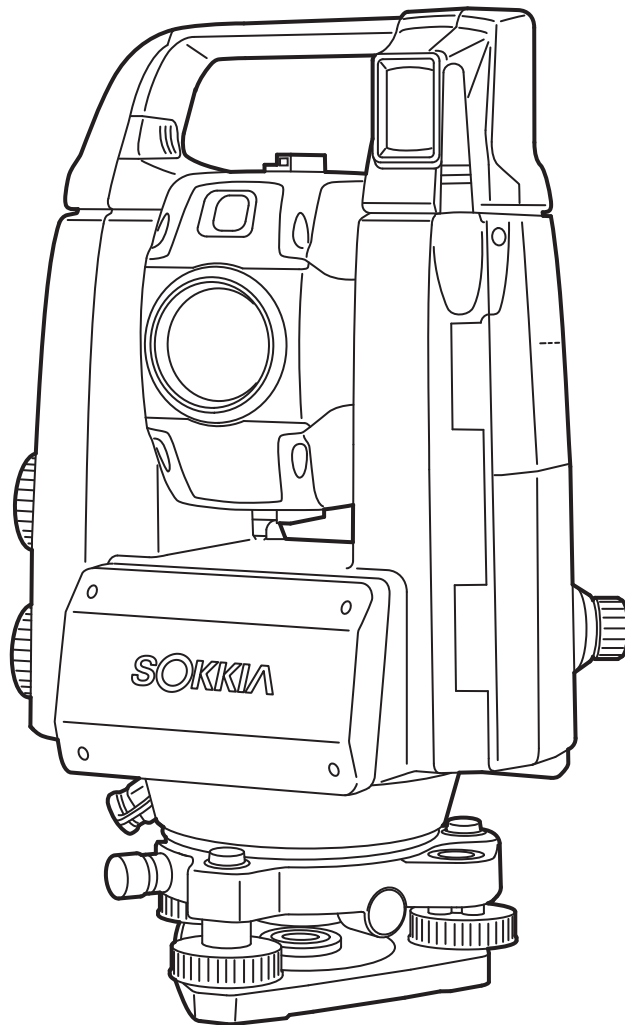

Class 3R Laser Product

**OPERATOR'S MANUAL**

1008477-02-B

# HOW TO READ THIS MANUAL

Thank you for selecting the iX-1000/500 series.

- Please read this Operator's manual carefully, before using this product.
- iX has a function to output data to a connected host computer. Command operations from a host computer can also be performed. For details, refer to "Communication manual" and ask your local dealer.
- The specifications and general appearance of the instrument are subject to change without prior notice and without obligation by TOPCON CORPORATION and may differ from those appearing in this manual.
- The content of this manual is subject to change without notice.
- Some of the diagrams shown in this manual may be simplified for easier understanding.
- Always keep this manual in a convenient location and read it when necessary.
- This manual is protected by copyright and all rights are reserved by TOPCON CORPORATION.
- Except as permitted by Copyright law, this manual may not be copied, and no part of this manual may be reproduced in any form or by any means.
- This manual may not be modified, adapted or otherwise used for the production of derivative works.

## Symbols

---

The following conventions are used in this manual.



: Indicates precautions and important items which should be read before operations.



: Indicates the chapter title to refer to for additional information.



: Indicates supplementary explanation.



: Indicates an explanation for a particular term or operation.

[MEAS] etc. : Indicates Operation icons on the display and window dialog buttons.

{ESC} etc. : Indicates keys on the operation panel.

<Screen title> etc.: Indicates screen titles.

## Notes regarding manual style

---

- Except where stated, "iX" means iX-1000/500 series in this manual.
  - Model with display on the both sides is available as a factory option depending on the country of purchase.
  - Location of Operation icons in screens used in procedures is based on the factory setting. It is possible to change the allocation of Operation icons.  
 "19. CHANGING THE SETTINGS"
  - Except where stated, instrument with RC Handle is used for illustration.
  - Learn basic operations in "4. PRODUCT OUTLINE" and "5. BASIC OPERATION" before you read each measurement procedure. For selecting options and inputting figures, see "5.1 Basic Key Operation".
  - Measurement procedures are based on continuous measurement. Some information about procedures when other measurement options are selected can be found in "Note" ().
- KODAK is a registered trademark of Eastman Kodak Company.
  - *Bluetooth*<sup>®</sup> is a registered trademark of Bluetooth SIG, Inc.
  - Windows is registered trademarks of Microsoft Corporation.
  - All other company and product names featured in this manual are trademarks or registered trademarks of each respective organization.



**JSIMA** This is the mark of the Japan Surveying Instruments Manufacturers Association.

# CONTENTS

1. PRECAUTIONS FOR SAFE OPERATION .....	1
2. PRECAUTIONS .....	4
3. LASER SAFETY INFORMATION .....	7
4. PRODUCT OUTLINE .....	9
4.1 Parts of the Instrument .....	9
4.2 Mode Structure .....	13
4.3 <i>Bluetooth</i> Wireless Technology/Wireless LAN .....	14
5. BASIC OPERATION .....	16
5.1 Basic Key Operation .....	16
5.2 Display Functions .....	18
5.3 Inputting Characters using the Input Panel .....	22
5.4 Starkey Mode .....	23
6. USING THE BATTERY .....	28
6.1 Battery Charging .....	28
6.2 Installing/Removing the Battery .....	29
7. SETTING UP THE INSTRUMENT .....	30
7.1 Centering .....	30
7.2 Levelling .....	31
8. POWER ON/OFF .....	33
8.1 Configuring the Touch Panel .....	34
8.2 Resolving Software Issues .....	34
8.3 Powering ON/OFF from an External Instrument .....	35
9. CONNECTING TO EXTERNAL DEVICES .....	36
9.1 Wireless Communication using <i>Bluetooth</i> Technology .....	36
9.2 Communication between the iX and Companion Device .....	39
9.3 Connection via RS232C Cable .....	40
9.4 Wireless LAN Settings and Communication .....	41
9.5 Cellular Settings and Communication .....	44
9.6 Connecting via USB Cable .....	47
9.7 Inserting USB Flash Drive .....	50
10. TARGET SIGHTING AND MEASUREMENT .....	51
10.1 Auto Pointing and Auto Tracking Settings .....	53
10.2 Auto Pointing and Auto Tracking Function for Target Sighting/Measurement .....	56
10.3 Manually Sighting the Target .....	59
11. ANGLE MEASUREMENT .....	60
11.1 Measuring the Horizontal Angle between Two Points (Horizontal Angle 0°) .....	60
11.2 Setting the Horizontal Angle to a Required Value (Horizontal Angle Hold) .....	61
11.3 Turning the Instrument from the Reference Angle to a Specified Angle .....	62
11.4 Angle measurement and Outputting the Data .....	63
12. DISTANCE MEASUREMENT .....	64
12.1 Returned Signal Checking .....	64
12.2 Distance and Angle Measurement .....	66
12.3 Using the Guide Light in Distance Measurement .....	66
12.4 Distance Measurement and Outputting the Data .....	68
12.5 REM Measurement .....	69
13. COORDINATE MEASUREMENT .....	71
13.1 Entering Instrument Station Data .....	71
13.2 Azimuth Angle Setting .....	72
13.3 3-D Coordinate Measurement .....	74
14. RESECTION MEASUREMENT .....	76
14.1 Coordinate Resection Measurement .....	77



14.2	Height Resection Measurement .....	81
15.	SETTING-OUT MEASUREMENT .....	85
15.1	Distance Setting-out Measurement .....	86
15.2	Using the Guide Light in Setting-out Measurement .....	86
15.3	Coordinates Setting-out Measurement .....	90
15.4	REM Setting-out Measurement .....	93
16.	OFFSET MEASUREMENT .....	96
16.1	Offset Single-distance Measurement .....	96
16.2	Offset Angle Measurement .....	98
16.3	Offset Two-distance Measurement .....	99
17.	MISSING LINE MEASUREMENT .....	102
17.1	Measuring the Distance between 2 or more Points .....	102
17.2	Changing the Starting Point .....	104
18.	SURFACE AREA CALCULATION .....	105
19.	CHANGING THE SETTINGS .....	108
19.1	Observation Conditions - Angle/Tilt .....	108
19.2	Observation Conditions - Dist .....	109
19.3	Observation Conditions - Reflector (Target) .....	112
19.4	Observation Conditions - Atmosphere .....	114
19.5	Instrument Conditions - Display .....	116
19.6	Instrument Conditions - Power .....	118
19.7	Instrument Conditions - Instrument .....	119
19.8	Instrument Conditions - Unit .....	120
19.9	Instrument Conditions - Password .....	121
19.10	Customizing Screen Controls .....	122
19.11	Instrument Conditions - Date and Time .....	122
19.12	Allocating Operating Icons .....	125
19.13	Changing Starkey Mode Icons .....	128
19.14	Restoring Default Settings .....	130
20.	WARNING AND ERROR MESSAGES .....	131
21.	CHECKS AND ADJUSTMENTS .....	134
21.1	Circular Level .....	134
21.2	Tilt Sensor .....	135
21.3	Reticle .....	136
21.4	Collimation .....	138
21.5	Image Sensor Reticle .....	139
21.6	Optical Plummet .....	142
21.7	Additive Distance Constant .....	143
21.8	Laser Plummet (Optional Accessory) .....	144
22.	CLOUD OAF .....	147
22.1	OAF Online Update .....	147
22.2	OAF Offline Update .....	150
23.	POWER SUPPLY SYSTEM .....	152
24.	TARGET SYSTEM .....	153
25.	ACCESSORIES .....	155
26.	SPECIFICATIONS .....	158
27.	EXPLANATIONS .....	165
27.1	High Accuracy with the 360° Prism .....	165
27.2	Manually Indexing the Vertical Circle by Face 1/2 Measurement .....	166
27.3	Correction for Refraction and Earth Curvature .....	167
28.	REGULATIONS .....	168
29.	INDEX .....	171



# 1. PRECAUTIONS FOR SAFE OPERATION

For the safe use of the product and prevention of injury to operators and other persons as well as prevention of property damage, items which should be observed are indicated by an exclamation point within a triangle used with WARNING and CAUTION statements in this operator's manual.















The definitions of the indications are listed below. Be sure you understand them before reading the manual's main text.

## Definition of Indication

	<b>WARNING</b>	Ignoring this indication and making an operation error could possibly result in death or serious injury to the operator.
	<b>CAUTION</b>	Ignoring this indication and making an operation error could possibly result in personal injury or property damage.

-  This symbol indicates items for which caution (hazard warnings inclusive) is urged. Specific details are printed in or near the symbol.
-  This symbol indicates items which are prohibited. Specific details are printed in or near the symbol.
-  This symbol indicates items which must always be performed. Specific details are printed in or near the symbol.

## General

-  **Warning**
  -  Do not use the unit in areas exposed to high amounts of dust or ash, in areas where there is inadequate ventilation, or near combustible materials. An explosion could occur.
  -  Do not perform disassembly or rebuilding. Fire, electric shock, burns, or hazardous radiation exposure could result.
  -  Never look at the sun through the telescope. Loss of eyesight could result.
  -  Do not look at reflected sunlight from a prism or other reflecting object through the telescope. Loss of eyesight could result.
  -  Direct viewing of the sun during sun observation will cause loss of eyesight. Use solar filter (option) for sun observation.
  -  When securing the instrument in the carrying case make sure to set all the locks. Failure to do so could result in the instrument falling out while being carried, causing injury.
-  **Caution**
  -  Do not use the carrying case as a footstool. The case is slippery and unstable so a person could slip and fall off it.
  -  Do not place the instrument in a damaged case or in a case with a damaged belt. The case or instrument could be dropped and cause injury.
  -  Do not touch the instrument or look through the telescope while the motor is in operation. Injury could result.
  -  Do not wield or throw the plumb bob. A person could be injured if struck.
  -  Secure handle to main unit. Failure to properly secure the handle could result in the unit falling off while being carried, causing injury.
  -  Tighten the adjustment tribrach clamp securely. Failure to properly secure the clamp could result in the tribrach falling off while being carried, causing injury.

---

**Power Supply**

---

**Warning**

Do not disassemble or rebuild the battery or the battery charger, nor expose to heavy shocks or vibration. Sparking, fire, electric shock or burns could result.



Do not short circuit. Heat or ignition could result.



Do not place articles such as clothing on the battery charger while charging batteries. Sparks could be induced, leading to fire.



Do not use voltage other than the specified power supply voltage. Fire or electrical shock could result.



Do not use batteries other than those designated. An explosion could occur, or abnormal heat generated, leading to fire.



Do not use damaged power cords, plugs or loose outlets. Fire or electric shock could result.



Do not use power cords other than those designated. Fire could result.



Use only the specified battery charger to recharge batteries. Other chargers may be of different voltage rating or polarity, causing sparking which could lead to fire or burns.



Do not use the battery or charger for any other equipment or purpose. Fire or burns caused by ignition could result.



Do not heat or throw batteries or chargers into fire. An explosion could occur, resulting in injury.



To prevent shorting of the battery in storage, apply insulating tape or equivalent to the terminals. Otherwise shorting could occur resulting in fire or burns.



Do not use the battery or the battery charger if its terminals are wet. Resultant poor contact or shorting could lead to fire or burns.



Do not connect or disconnect power supply plugs with wet hands. Electric shock could result.

**Caution**

Do not touch liquid leaking from batteries. Harmful chemicals could cause burns or blisters.

---

**Tripod**

---

**Caution**

When mounting the instrument to the tripod, tighten the centering screw securely. Failure to tighten the screw properly could result in the instrument falling off the tripod, causing injury.



Tighten securely the leg fixing screws of the tripod on which the instrument is mounted. Failure to tighten the screws could result in the tripod collapsing, causing injury.



Do not carry the tripod with the tripod shoes pointed at other persons. A person could be injured if struck by the tripod shoes.



Keep hands and feet away from the tripod shoes when fixing the tripod in the ground. A hand or foot stab wound could result.



Tighten the leg fixing screws securely before carrying the tripod. Failure to tighten the screws could lead to the tripod legs extending, causing injury.

## Wireless technologies

---



### Warning



Do not use within the vicinity of hospitals. Malfunction of medical equipment could result.



Use the instrument at a distance of at least 22 cm from anyone with a cardiac pacemaker. Otherwise, the pacemaker may be adversely affected by the electromagnetic waves produced and cease to operate as normal.



Do not use onboard aircraft. The aircraft instrumentation may malfunction as a result.



Do not use within the vicinity of automatic doors, fire alarms and other devices with automatic controls as the electromagnetic waves produced may adversely affect operation resulting in an accident.

## 2. PRECAUTIONS

### Charging Battery

---

- Be sure to charge the battery within the charging temperature range.  
Charging temperature range : 0 to 40°C
- Use only the specified battery or the battery charger. Failures caused by using other batteries or battery chargers are out of warranty including the main unit.

### Warranty policy for Battery

---

- Battery is an expendable item. The decline in retained capacity depending on the repeated charging/discharging cycle is out of warranty.

### Bluetooth Wireless Technology/Wireless LAN

---

- *Bluetooth* function may not be built in depending on telecommunications regulations of the country or the area where the instrument is purchased. Contact your local dealer for the details.

### Telescope

---

- Aiming the telescope at the sun will cause internal damage to the instrument. Use the solar filter when observing the sun.  
☞ "25. ACCESSORIES"

### Tribrach Clamp and Handle

---

- When the instrument is shipped, the tribrach clamp is held firmly in place with a locking screw to prevent the instrument from shifting on the tribrach. Before using the instrument the first time, loosen this screw with a screwdriver. And before transporting it, tighten the locking screw to fasten the tribrach clamp in place so that it will not shift on the tribrach.
- The handle of the instrument can be removed. When operating the instrument with the handle attached, always make sure that the handle is securely fixed to the instrument body with the handle locks.

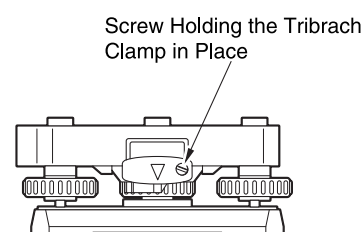

### Precautions concerning water and dust resistance

---

The instrument conforms to IP65 specifications for waterproofing and dust resistance when battery cover, connector cap and the external interface hatch are closed.

- Be sure to correctly attach the connector caps to protect the instrument from moisture and dust particles when the connector is not in use.
- Make sure that moisture or dust particles do not come in contact with the terminal or connectors. Operating the instrument with moisture or dust on the terminal or connectors may cause damage to the instrument.
- Make sure that the inside of the carrying case and the instrument are dry before closing the case. If moisture is trapped inside the case, it may cause the instrument to rust.
- If there is a crack or deformation in the rubber packing for the battery cover or external interface hatch, stop using and replace the packing.
- To retain the waterproof property, it is recommended that you replace the rubber packing once every two years. To replace the packing, contact your local dealer.

### The Lithium Battery

---

- The lithium battery is used to maintain the Calendar & Clock function. It can back up data for approximately 5 years of normal use and storage (Temperature = 20°, humidity = about 50%), but its lifetime may be shorter depending on circumstances.



**Tribrach**

---

- Always use the tribrach provided. During a traverse observation, it is recommended to use the same type of tribrach for the target as well for accurate observations.

**Backing up data**

---

- Data should be backed up (transferred to an external device etc.) on a regular basis to prevent data loss.

**Other precautions**

---

- Never place the instrument directly on the ground. Sand or dust may cause damage to the screw holes or the centering screw on the base plate.
- Do not perform vertical rotation of the telescope when using the lens hood, diagonal eyepiece, or solar filter. Such accessories may strike the instrument causing damage.
- Protect the instrument from heavy shocks or vibration.
- Protect the instrument from rain or drizzle with an umbrella or waterproof cover.
- Never carry the instrument on the tripod to another site.
- Turn the power off before removing the battery.
- Remove the battery before placing the instrument in its case.
- Make sure that the instrument and the protective lining of the carrying case are dry before closing the case. The case is hermetically sealed and if moisture is trapped inside, the instrument could rust.
- Consult your local dealer before using the instrument under special conditions such as long periods of continuous use or high levels of humidity. In general, special conditions are treated as being outside the scope of the product warranty.

**Maintenance**

---

- Wipe off moisture completely if the instrument gets wet during survey work.
- Always clean the instrument before returning it to the case. The lens requires special care. First, dust it off with the lens brush to remove tiny particles. Then, after providing a little condensation by breathing on the lens, wipe it with the silicon cloth.
- If the display is dirty, carefully wipe it with a soft, dry cloth. To clean other parts of the instrument or the carrying case, lightly moisten a soft cloth in a mild detergent solution. Wring out excess water until the cloth is slightly damp, then carefully wipe the surface of the unit. Do not use any alkaline cleaning solutions, alcohol, or any other organic solvents on the instrument or display.
  - ☞ For temporal de-activating the touch panel, see "5.2 Display Functions Temporarily de-activating the touch panel",
- Store the instrument in a dry room where the temperature remains fairly constant.
- Check the tripod for loose fit and loose screws.
- If any trouble is found on the rotatable portion, screws or optical parts (e.g. lens), contact your local dealer.
- When the instrument is not used for a long time, check it at least once every 3 months.
  - ☞ "21. CHECKS AND ADJUSTMENTS"
- When removing the instrument from the carrying case, never pull it out by force. The empty carrying case should be closed to protect it from moisture.
- Check the instrument for proper adjustment periodically to maintain the instrument accuracy.

### **Exporting this product (Relating EAR)**

---

- This product is equipped with the parts/units, and contains software/technology, which are subject to the EAR (Export Administration Regulations). Depending on countries you wish to export or bring the product to, a US export license may be required. In such a case, it is your responsibility to obtain the license. The countries requiring the license as of May 2013 are shown below. Please consult the Export Administration Regulations as they are subject to change.

North Korea

Iran

Syria

Sudan

Cuba

URL for the EAR of the US: <http://www.bis.doc.gov/policiesandregulations/ear/index.htm>

### **Exporting this product (Relating telecommunications regulations)**

---

- Wireless communication module is incorporated in the instrument. Use of this technology must be compliant with telecommunications regulations of the country where the instrument is being used. Even exporting the wireless communication module may require conformity with the regulations. Contact your local dealer in advance.

### **Exceptions from responsibility**

---

- The user of this product is expected to follow all operating instructions and make periodic checks (hardware only) of the product's performance.
- The manufacturer, or its representatives, assumes no responsibility for results of faulty or intentional usage or misuse including any direct, indirect, consequential damage, or loss of profits.
- The manufacturer, or its representatives, assumes no responsibility for consequential damage, or loss of profits due to any natural disaster, (earthquake, storms, floods etc.), fire, accident, or an act of a third party and/or usage under unusual conditions.
- The manufacturer, or its representatives, assumes no responsibility for any damage (change of data, loss of data, loss of profits, an interruption of business etc.) caused by use of the product or an unusable product.
- The manufacturer, or its representatives, assumes no responsibility for any damage, and loss of profits caused by usage different to that explained in the operator's manual.
- The manufacturer, or its representatives, assumes no responsibility for damage caused by incorrect operation, or action resulting from connecting to other products.

# 3. LASER SAFETY INFORMATION

The instrument is classified as the following class of Laser Product according to IEC Standard Publication 60825-1 Ed.3.0: 2014 and United States Government Code of Federal Regulation FDA CDRH 21CFR Part 1040.10 and 1040.11 (Complies with FDA performance standards for laser products except for deviations pursuant to Laser Notice No.50, dated June 24, 2007.)

Device		Laser class
EDM device in objective lens	Light beam used for measurement (When target (reflector) is set to N-prism.)	Class 3R
	Light beam used for measurement (When target (reflector) is set to prism or reflective sheet.)	Class 1
	Laser-pointer	Class 3R
	Light beam for Auto Pointing	Class 1
Laser plummet (optional accessory)		Class2

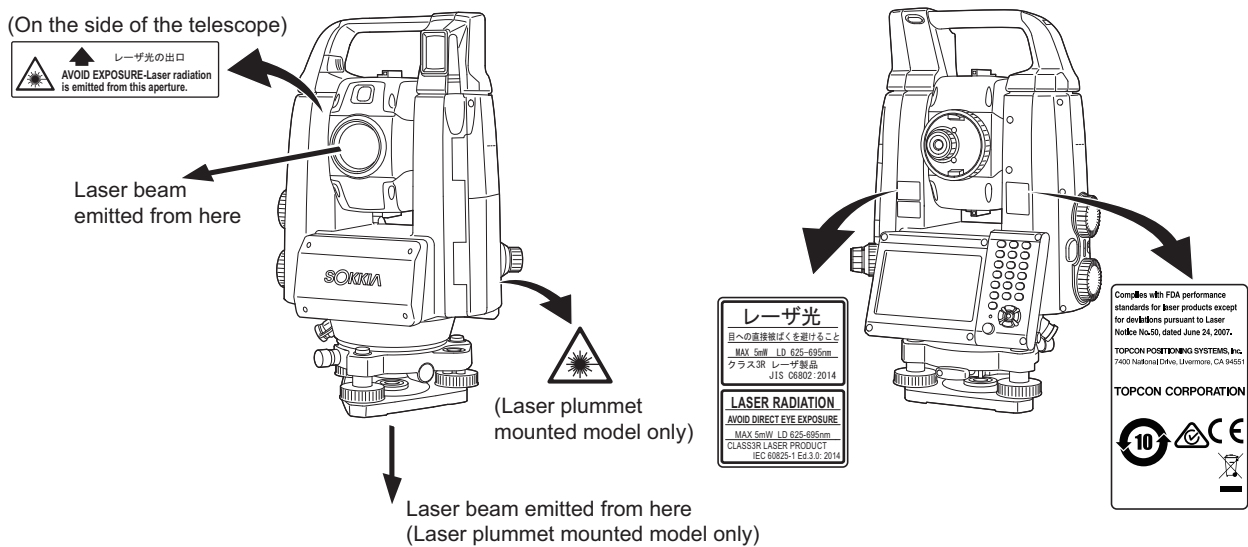

- EDM device is classified as Class 3R Laser Product when reflectorless measurement is selected. When target (reflector) is set to prism or reflective sheet, the output is equivalent to the safer class 1.

## ⚠ Warning

- Use of controls or adjustments or performance of procedures other than those specified herein may result in hazardous radiation exposure.
- Follow the safety instructions on the labels attached to the instrument as well as in this manual to ensure safe use of this laser product.
- Never intentionally point the laser beam at another person. The laser beam is injurious to the eyes and skin. If an eye injury is caused by exposure to the laser beam, seek immediate medical attention from a licensed ophthalmologist.
- Do not look directly into the laser beam source or guide light source. Doing so could cause permanent eye damage.
- Do not stare at the laser beam. Doing so could cause permanent eye damage.
- Never look at the laser beam through a telescope, binoculars or other optical instruments. Doing so could cause permanent eye damage.
- Sight targets so that the laser beam does not stray from them.

**⚠ Caution**

- Perform checks at start of work and periodic checks and adjustments with the laser beam emitted under normal conditions.
- When the instrument is not being used, turn off the power and replace the lens cap.
- When disposing of the instrument, destroy the battery connector so that the laser beam cannot be emitted.
- Operate the instrument with due caution to avoid injuries that may be caused by the laser beam unintentionally striking a person in the eye. Avoid setting the instrument at heights at which the path of the laser beam may strike pedestrians or drivers at head height.
- Never point the laser beam at mirrors, windows or surfaces that are highly reflective. The reflected laser beam could cause serious injury.
- Only those who have been received training as per the following items shall use this product.
  - Read this manual for usage procedures for this product.
  - Hazardous protection procedures (read this chapter).
  - Requisite protective gear (read this chapter).
  - Accident reporting procedures (stipulate procedures beforehand for transporting the injured and contacting physicians in case there are laser induced injuries).
- Persons working within the range of the laser beam are advised to wear eye protection which corresponds to the laser wavelength of the instrument being used. (OD2)
- Areas in which the laser is used should be posted with a standard laser warning sign.
- When using the laser-pointer function, be sure to turn OFF the output laser after distance measurement is completed. Even if distance measurement is canceled, the laser-pointer function is still operating and the laser beam continues to be emitted.

# 4. PRODUCT OUTLINE

## 4.1 Parts of the Instrument

### Parts and functions of the instrument

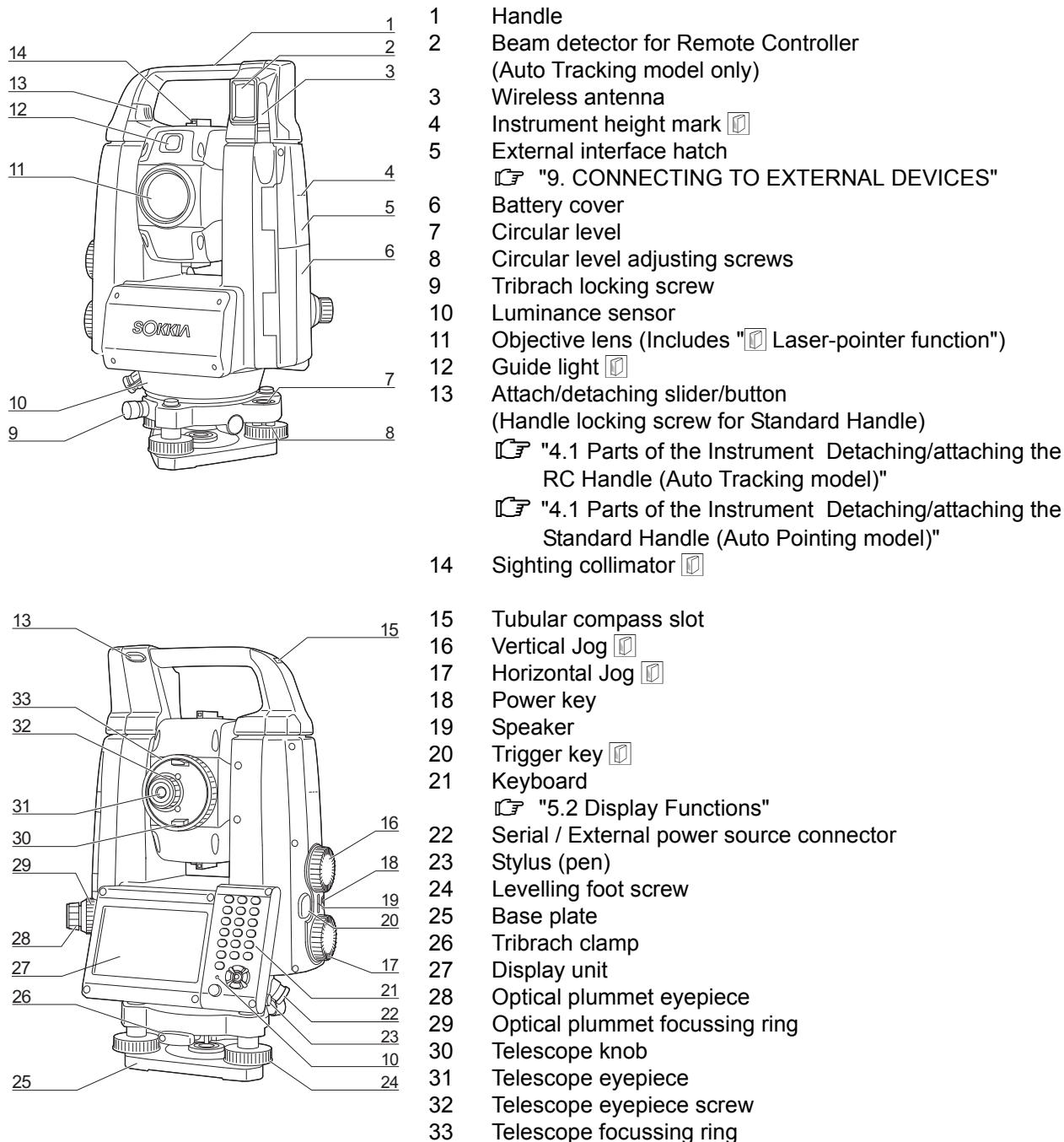

#### Instrument height mark

The height of the instrument is as follows:

- 192.5mm (from tribrach mounting surface to this mark)
- 236mm (from tribrach plate to this mark)

"Instrument height" is input when setting instrument station data and is the height from the surveying point (where the instrument is mounted) to this mark.

#### Laser-pointer function

A target can be sighted with a red laser beam in dark locations without the use of the telescope.



### Guide light

Setting-out measurement etc. can be carried out effectively using the guide light. The guide light is composed of a light that is divided into green and red sections. A poleman can ascertain the present position by checking the guide light color.

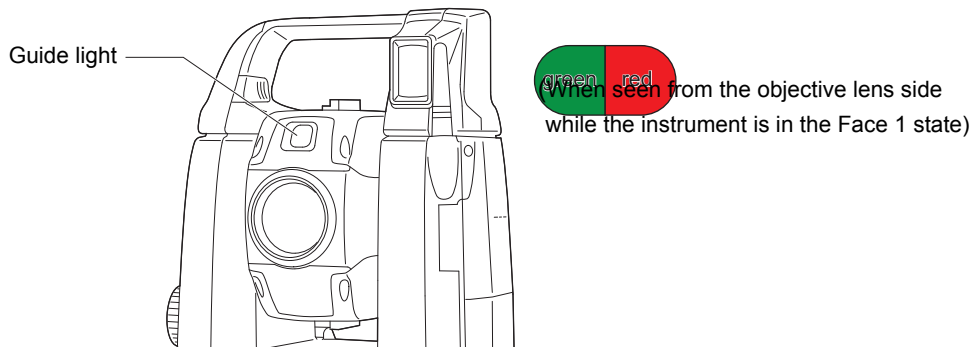

### ●Guide light status

Light status	Meaning
Slow flashing (Red and green simultaneously)	Waiting
	Search error (error screen only)
Fast flashing (Red and green simultaneously)	Searching in progress
	Measuring (continuous measurement)
	Returned signal checking in progress
	Auto Tracking in progress (Auto Tracking model only)
Green and red alternate flashing	Auto Tracking in predicted direction (Auto Tracking model only)
	Distance measurement error (no signal, sighting error)
	"Prism wait"

☞ "12.2 Using the Guide Light in Distance Measurement", "15.1 Using the Guide Light in Setting-out Measurement"



### Sighting collimator

Use sighting collimator to aim the instrument in the direction of the measurement point.

Turn the instrument until the apex of the triangle in the sighting collimator is aligned with the target. A circle surrounds the triangle to make it easier to locate.



### Vertical and Horizontal Jogs

The instrument and telescope can be rotated manually by hand or, for more precise adjustments, by turning the vertical and horizontal Jogs.



### Trigger key

When the Trigger key is pressed the instrument carries out the operation indicated by the orange

Operating icon on the screen. This allows the user to continue operation without having to return to the display to press Operating icons.

## Wireless antenna

The wireless antenna allows communication via wireless technologies.



- Handle the antenna with care. The antenna may be damaged if struck during operation or while being stored in the carrying case.

### Detaching/attaching the RC Handle (Auto Tracking model)

The carrying handle can be removed from the instrument when the prism is located at the zenith etc.



- Never touch the beam detector. The ability of the system to perform Turning may be adversely affected. If the beam detector is dirty, carefully wipe it with the silicon cloth.

1. Press the attach/detaching button and then move the handle to the right while sliding the attach/detaching slider to the direction indicated in the arrow.

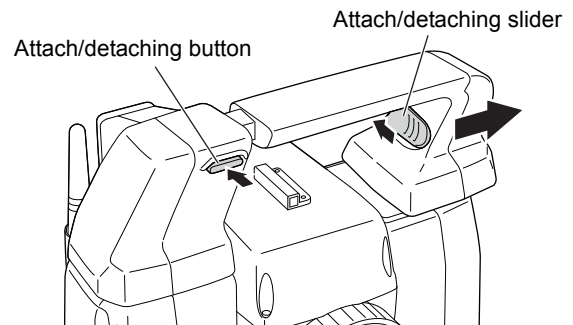

2. Along with the step 1, lift it up to detach.

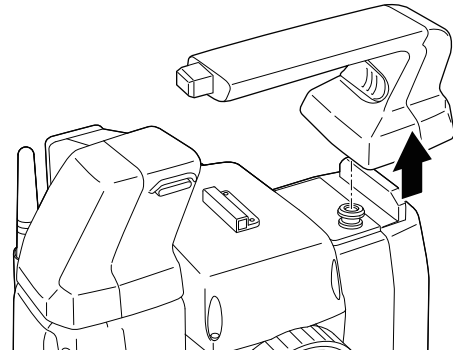

### Detaching/attaching the Standard Handle (Auto Pointing model)

The carrying handle can be removed from the instrument when the prism is located at the zenith etc.

1. To remove it, loosen the handle rocking screws.
2. To attach the handle, position the handle as shown, tighten the 2 handle rocking screws securely.

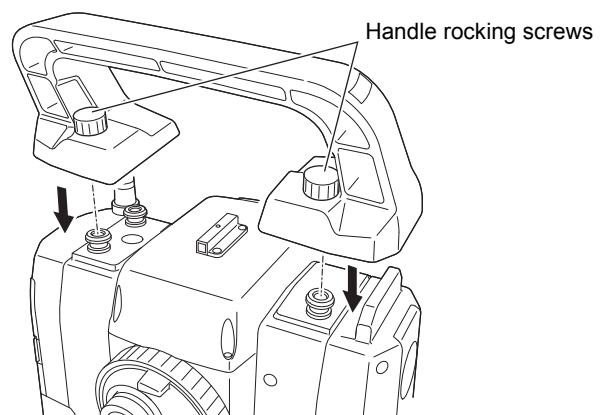

---

### Detaching the instrument from the tribrach

---

1. Loosen the tribrach locking screw by turning 2 or 3 rotations in the counterclockwise direction.
2. Turn the tribrach clamp counterclockwise to loosen.
3. Lift the instrument to detach.

### Attaching the instrument to the tribrach

---

1. Check that the tribrach locking screw has been loosened.
2. Align (1) and (2) and lower the instrument onto the tribrach.
3. Turn the tribrach clamp clockwise to tighten.
4. Turn the tribrach locking screw (3) clockwise to tighten.

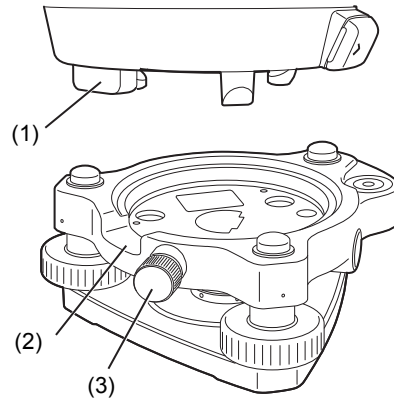

**Note**

- Always fully tighten the tribrach locking screw to reduce adverse effects of motor operation on accuracy and ensure optimal results.



## 4.2 Mode Structure

The diagram below describes the different modes of the instrument and key operations for navigating between them.

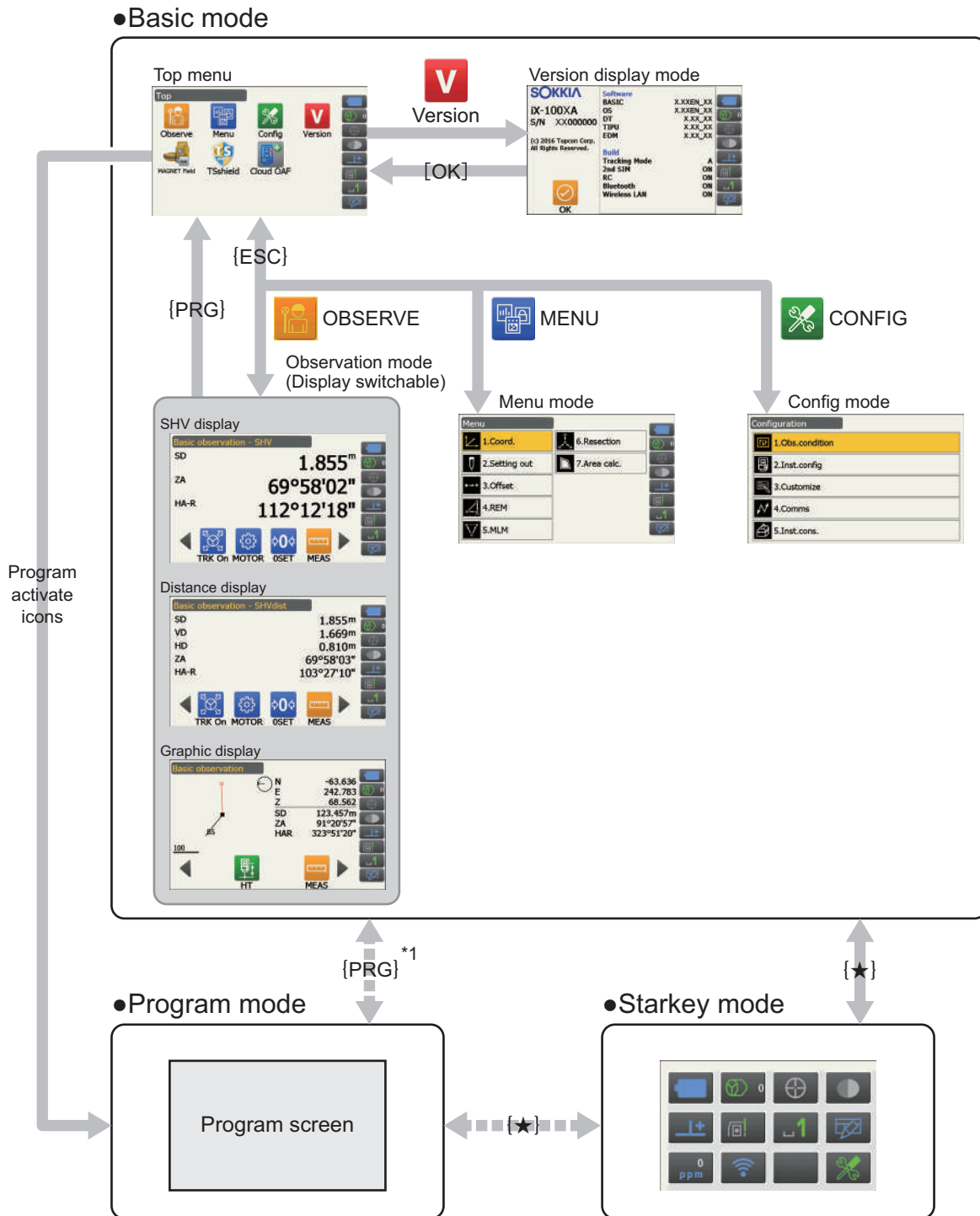

■ ■ ■ ■ : Available only when a program is activated.

\*1: The previous screen {PRG} is pressed is recovered. However one of the observation screens is recovered just after a program is activated.



- Switching between modes is not possible during distance measurement.
- Do not switch between modes by {PRG} or not turn OFF the power just after pressing {PRG} (when a program is activated or quit).



- "TSshield" and "Cloud OAF" may not be installed on the instrument depending on the country or the area where the instrument is purchased.

### 4.3 Bluetooth Wireless Technology/Wireless LAN



- *Bluetooth*/Wireless LAN function may not be built in depending on telecommunications regulations of the country or the area where the instrument is purchased. Contact your local dealer for the details.
- Use of this technology must be authorized according to telecommunications regulations of the country where the instrument is being used. Contact your local dealer in advance.
  - ☞ "28. REGULATIONS"
- TOPCON CORPORATION is not liable for the content of any transmission nor any content related thereto. When communicating important data, run tests beforehand to ascertain that communication is operating normally.
- Do not divulge the content of any transmission to any third party.

#### Radio interference when using *Bluetooth* technology/Wireless LAN

*Bluetooth*/Wireless LAN communication with the iX uses the 2.4 GHz frequency band. This is the same band used by the devices described below.

- Industrial, scientific, and medical (ISM) equipment such as microwaves and pacemakers.
- portable premises radio equipment (license required) used in factory production lines etc.
- portable specified low-power radio equipment (license-exempt)
- IEEE802.11b/IEEE802.11g/IEEE802.11n standard wireless LAN devices (When using *Bluetooth* function)
- The above devices use the same frequency band as *Bluetooth* communications. As a result, using the iX within proximity to the above devices may result in interference causing communication failure or reduction of transmission speed.
- *Bluetooth* devices (when Wireless LAN function)

Although a radio station license is not required for this instrument, bear in mind the following points when using *Bluetooth* technology for communication.

- **Regarding portable premises radio equipment and portable specified low-power radio equipment:**
  - Before starting transmission, check that operation will not take place within the vicinity of portable premises radio equipment or specified low-power radio equipment.
  - In the case that the instrument causes radio interference with portable premises radio equipment, terminate the connection immediately and take measures to prevent further interference (e.g. connect using an interface cable).
  - In the case that the instrument causes radio interference with portable specified low-power radio equipment, contact your local dealer.
- **When using *Bluetooth* function in proximity to IEEE802.11b/IEEE802.11g/IEEE802.11n standard wireless LAN devices, turn off all wireless LAN devices not being used and vice versa.**
  - Interference may result, causing transmission speed to slow or even disrupting the connection completely. Turn off all devices not being used.
- **Do not use the iX in proximity to microwaves.**
  - Microwave ovens can cause significant interference resulting in communication failure. Perform communication at a distance of 3m or more from microwave ovens.

**● Refrain from using the iX in proximity to televisions and radios.**

- Televisions and radios use a different frequency band to *Bluetooth*/Wireless LAN communications. However, even if the iX is used within proximity to the above equipment with no adverse effects with regard to *Bluetooth*/Wireless LAN communication, moving a *Bluetooth*/Wireless LAN compatible device (including the iX) closer to said equipment may result in electronic noise in sound or images, adversely affecting the performance of televisions and radios.

**Precautions regarding transmission**

---

**● For best results**

- The usable range becomes shorter when obstacles block the line of sight, or devices such as PDAs or computers are used. Wood, glass and plastic will not impede communication but the usable range becomes shorter. Moreover, wood, glass and plastic containing metal frames, plates, foil and other heat shielding elements as well as coatings containing metallic powders may adversely affect *Bluetooth* communication and concrete, reinforced concrete, and metal will render it impossible.
- Use a vinyl or plastic cover to protect the instrument from rain and moisture. Metallic materials should not be used.
- The direction of the *Bluetooth* antenna can have adverse effects upon usable range.

**● Reduced range due to atmospheric conditions**

- The radio waves used by the iX may be absorbed or scattered by rain, fog, and moisture from the human body with the limit of usable range becoming lower as a result. Similarly, usable range may also shorten when performing communication in wooded areas. Moreover, as wireless devices lose signal strength when close to the ground, perform communication at as high a position as possible.



- TOPCON CORPORATION cannot guarantee full compatibility with all *Bluetooth*/Wireless LAN products on the market.

# 5. BASIC OPERATION

Learn basic key operations here before you read each measurement procedure.

## 5.1 Basic Key Operation

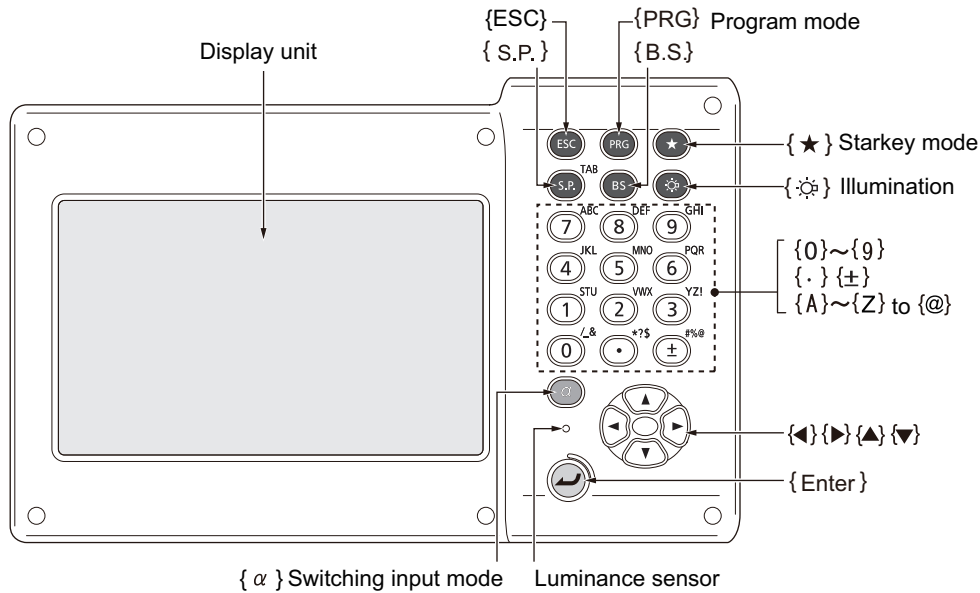

### ● Power ON/OFF

☞ "8. POWER ON/OFF"

### ● Lighting up the reticle/keys and selecting screen backlight brightness

{☀}	Switches the reticle illumination and key light On/Off (When Key light is On, backlight brightness goes down)
-----	---------------------------------------------------------------------------------------------------------------

☞ Brightness level: "19.7 Instrument Conditions - Instrument"

### ● Switching to Starkey mode

{★}	Switches to Starkey mode/previous screen
-----	------------------------------------------

☞ "5.4 Starkey Mode"

### ● Switching to Program mode

{PRG}	Switches to Program mode/Basic mode
-------	-------------------------------------



- Do not switch between modes by {PRG} or not turn OFF the power just after pressing {PRG} (when a program is activated or quit).

### ● Switching the Laser-pointer/Guide light ON/OFF

{☀} (Press and hold until a beep sounds)	Turn ON/OFF the laser-pointer/guide light
------------------------------------------	-------------------------------------------

☞ "Switching {☀} function: 19.7 Instrument Conditions - Instrument"



- Changes can also be made by tapping the icon on Status icon or in Starkey mode.  
☞ "5.2 Display Functions Status icons", "5.4 Starkey Mode"

### ● Inputting letters/figures

{α}	Switch numerals/alphabetic characters (upper case)/alphabetic characters (lower case)
{α} + {▼}	Display/hide <Input Panel>
{0} to {9}	Input numeral or symbol printed above the key (during numeric input mode) Input alphabetic character in the order they are listed (in alphabetic input mode)
{.}	Input a decimal point (during numeric input mode) Input code (in alphabetic input mode)
{±}	Input a plus or minus sign (during numeric input mode) Input code (in alphabetic input mode)
{ESC}	Cancel the input data
{α} + {S.P}	Shift to the next item
{B.S.}	Delete a character on the left.
{S.P.}	Input a blank space (increments by 1 when setting the date and time)
{◀}/▶}	Move the cursor left/right
{▲}/▼}	Move the cursor up/down
{Enter}	Select/accept input word/value

☞ Inputting rule and inputting special characters: "5.3 Inputting Characters using the Input Panel"

### ● Selecting options

{▲}/▼}	Move the cursor/selection item up/down
{◀}/▶}	Move the cursor/selection item left/right or select other option
{α} + {S.P}	Shift to the next item
{S.P.}	Display other options
{Enter}	Select/accept the option

### ● Others

{ESC}	Return to previous screen
-------	---------------------------

## 5.2 Display Functions

Screens can be operated using the keys on the keyboard or the touch panel. The touch panel can be operated using either the stylus pen provided or your fingers.

It is also possible to de-activate the touch panel temporarily.



- Do not scratch the display or use any sharp implement other than the stylus pen to operate the touch panel.



### Using the stylus

The stylus pen can be used to select menus and buttons on the screen and operate the scroll bar.

### Temporarily de-activating the touch panel

The touch panel can be temporarily de-activated. This is especially useful when cleaning the display.

To de-activate, tap  on the Status icon. The screen below is displayed.

 Allocating : "19.13 Changing Starkey Mode Icons"



The touch panel cannot be operated while the above message is displayed. Press **{ESC}** to cancel the message and re-activate the touch panel.



- Keyboard operation is partially limited during the Temporarily de-activating the touch panel.

### Displaying and operating screens

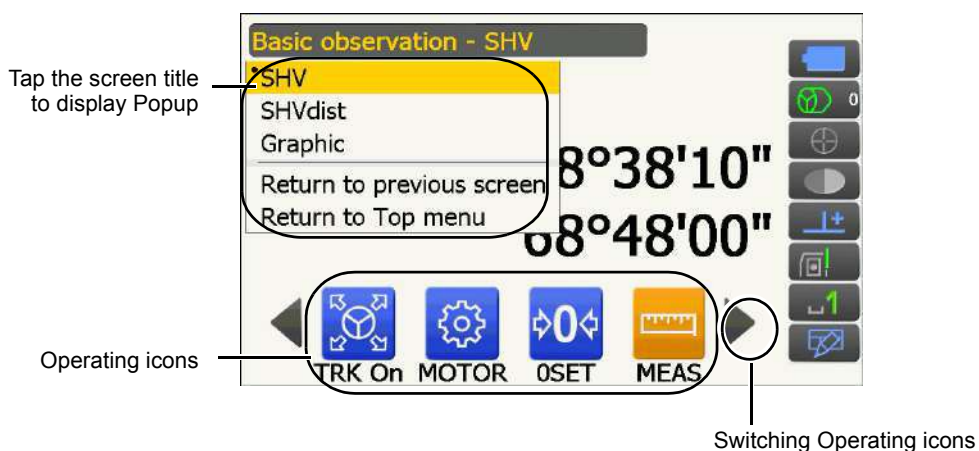

- Operating icon allocations, displayed items, and character sizes can all be changed in accordance with user preferences.

 "19. CHANGING THE SETTINGS"

## Top menu

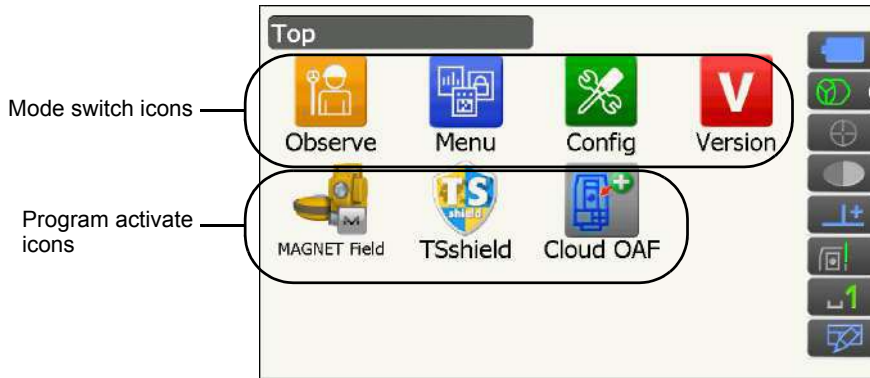

### Note

- "TSshield" and "Cloud OAF" may not be installed depending on the country or the area where the instrument is purchased.
- Only one program can be activated at a time. Icons whose background are gray cannot be selected.

## Version display mode screen



## Observation mode screen "SHV" display

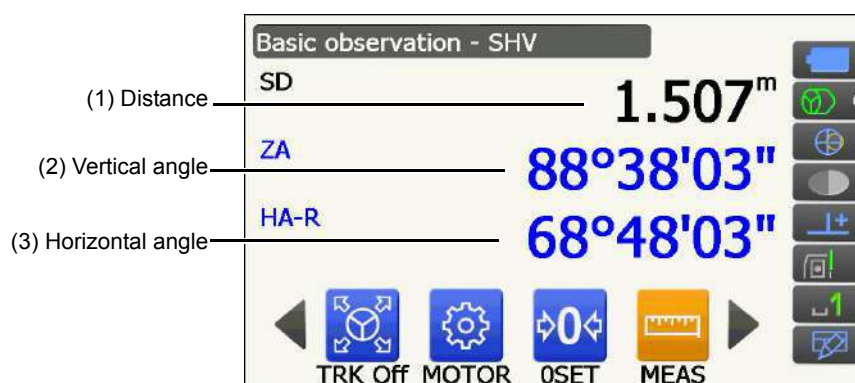

### (1) Distance

Display status can be switched between SD (slope distance)/HD (horizontal distance)/VD (vertical distance).

"19.2 Observation Conditions - Dist"

### (2) Vertical angle

The Vertical angle display can be switched between Zenith (Z=0°)/Horiz (H=0°)/Horiz (H=±90°)

To switch vertical angle/slope in %, press **[ZA/%]** when allocated to the Observation mode screen.

"19.1 Observation Conditions - Angle/Tilt"

The capitalized letter in the Operating icon indicates the currently selected mode.

 Allocating **[ZA/%]**: "19.12 Allocating Operating Icons"

### (3)Horizontal angle

Press **[R/L]** to switch the display status between HA-R (horizontal angle right)/HA-L (horizontal angle left).

The capitalized letter in the Operating icon indicates the currently selected mode.

 Allocating **[R/L]**: "19.12 Allocating Operating Icons"

#### Note

- Horizontal distance and height difference are also displayed in "SHVdist" display of Observation mode.

### Measuring screen

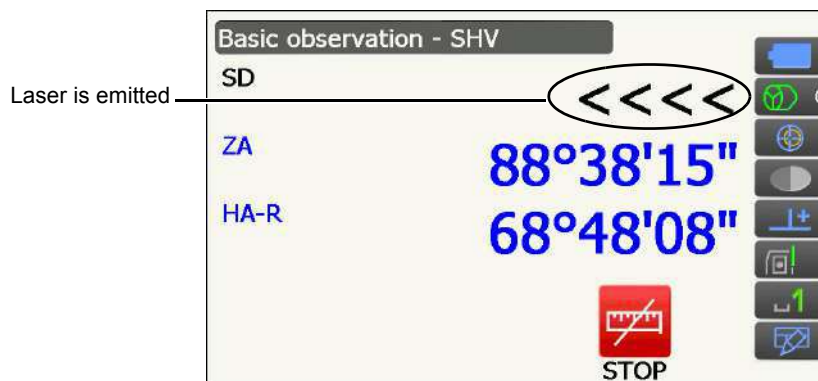

### Observation mode screen "Graphic" display

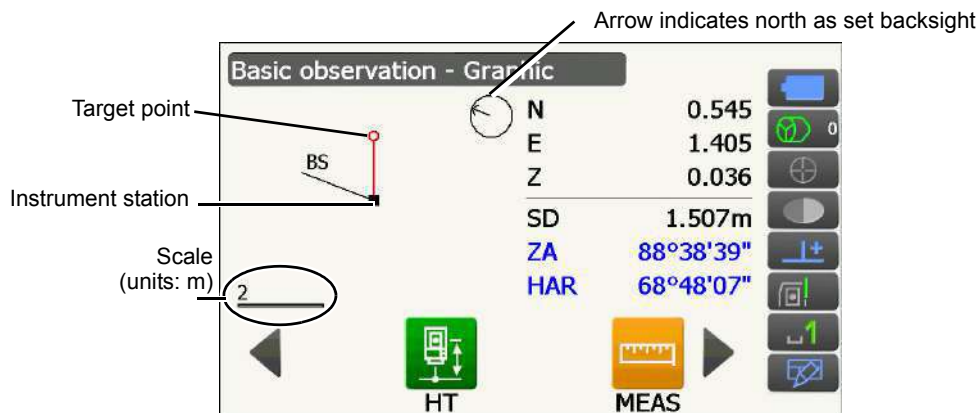

Following operations are available by switching Operating icons.

**[CNFG]** : In <Graphic configuration> the user can specify the orientation of the "graphic" display and which point, target or station, to set at the center of the display.

**[DEF.]** : Returns to the original orientation display.

**[ZoomIn]**: Zooms in.

**[ZoomOut]**:Zooms out.



## Selecting menus

To select a menu, tap the touch panel or press the relevant number key.

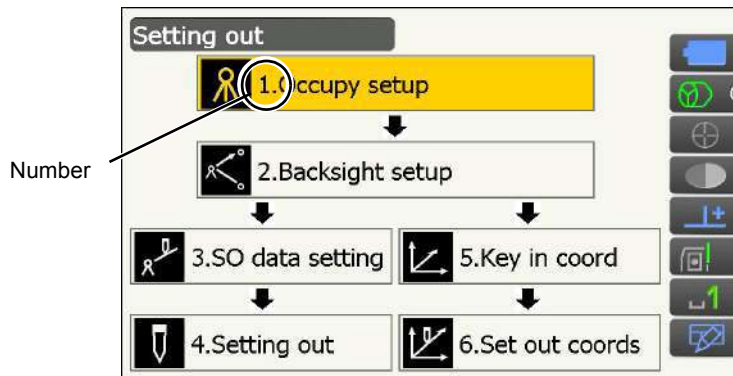

## Status icons

Indicate the current status of the instrument.

Tapping icons will switch between the relevant options for that item.

Tapping and holding will display a list of all available options for that item and, in certain cases, a link to the configuration screen for that item.





Allocation of the icons of the Status icon corresponds with that of Starkey mode.

📖 About icons: "5.4 Starkey Mode"

### 5.3 Inputting Characters using the Input Panel

To display <Input Panel>, tap  of Status icon/Starkey mode or while pressing {α} press {▼}. This keyboard can be used to input numeric and alphabetic characters as well as symbols. Tap the icon again to close.

#### Note

- When <Input Panel> is covering the  icon of the Status icon, use the stylus pen to drag the input panel to another part of the screen so that you can access the  icon.

#### Input panel

Input Panel												
Esc	1	2	3	4	5	6	7	8	9	0	- =	↵
Tab	q	w	e	r	t	y	u	i	o	p	[ ]	
CAP	a	s	d	f	g	h	j	k	l	;	'	
Shift	z	x	c	v	b	n	m	,	.	/	↵	
Ctl	áü	ˆ	\								↓	↑

- Esc : Deletes all input characters
- Tab : Moves the cursor to the next text box
- CAP : Alternates between upper and lower case alphabetic characters and numbers/symbols
- Shift : Alternates between upper and lower case alphabetic characters and numbers/symbols. Is canceled after inputting a single character.
- Ctl : No function
- Del/↵ : Delete the character to the left/right or deletes the entire text in the active section
- ↔ : Move the cursor left/right
- ENT : Accept input characters
- Space : Input a blank space
- áü : Accesses further Latin/Germanic characters/symbols. Is canceled after inputting a single character.

## 5.4 Starkey Mode

Via Starkey mode, you can jump from each Basic mode screen to the screen of checking/changing the various settings directly. Press starkey {★} to enter Starkey mode. Each icon can be tapped or pressed and hold in the same way with Status icon.

- 12 icons allocated in Starkey mode and the above 8 icons correspond with that Status icon
- Allocation of the icons can be changed.

☞ Changing allocation of Starkey mode: "19.13 Changing Starkey Mode Icons"

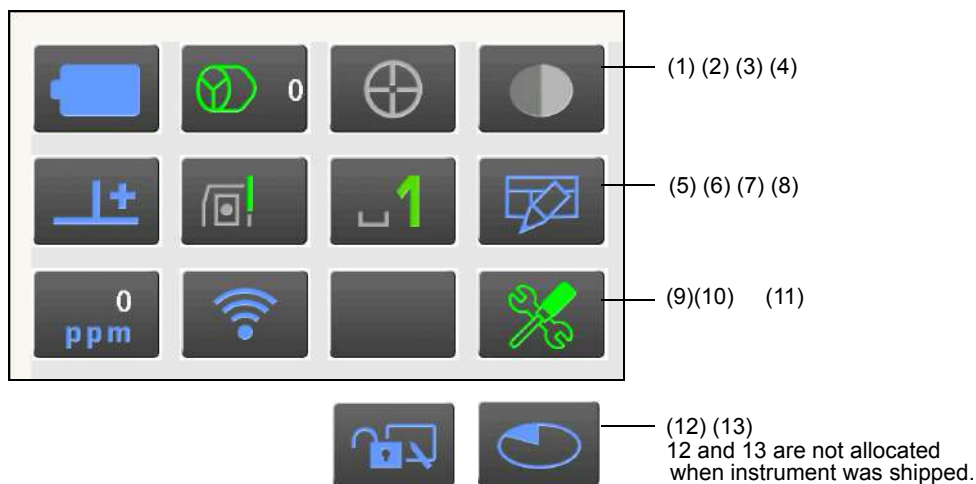

Indicates the current status of the instrument.

Tapping icons will switch between the relevant options for that item. Tapping and holding will display a list of all available options for that item and, in certain cases, a link to the configuration screen for that item.

Details of each icon are described below. (The numbers correspond to above icons).

### (1) Battery icon

Remaining battery power indicator (Temperature = 20°C, EDM on).

The remaining battery power displayed when distance measurement is in progress may differ to that displayed at other times.

You can jump to the Power config. screen.

☞ "19.6 Instrument Conditions - Power"

Go to Power supply config.

When using standard battery (BDC70)

- : Level 3 Full power
  - : Level 2 Plenty of power remains.
  - : Level 1 Half or less power remains.
  - : Level 0 Little power remains. Prepare a replacement battery. (Flashes red and black)
  - : No power Stop operation and charge the battery. (Red display in the center of the screen)
- ☞ "6.1 Battery Charging"

When using external battery (BDC60A/61A)

- : Level 3 Full power
  - : Level 2 Plenty of power remains.
  - : Level 1 Half or less power remains.
  - : Level 0 Little power remains. Prepare a replacement battery.
- ☞ "6.1 Battery Charging"

## (2) Target type icon

Selection of target type and configuration of prism constant correction value.

You can jump to the Distance config. or Reflector config. screen.

"19.2 Observation Conditions - Dist"

"19.3 Observation Conditions - Reflector (Target)"

•Prism 0mm		: Prism (0 mm)
360°Prism -7mm		: 360° prism (-7 mm)
Sheet 0mm		: Sheet (0 mm)
N-Prism		: N-Prism
Prism+ 0mm		: "+" indicates a target used with an external device or in a program installed in the Program mode.
Go to Dist config.		
Go to Reflector config.		

## (3) Motor icon

Configuration of Auto Pointing/Auto Tracking status. The display may change slightly depending on the target type selected. Auto Tracking items are only relevant to Auto Tracking models and are not available for Auto Pointing models.

You can jump to the Search/Track config. screen.

"10.1 Auto Pointing and Auto Tracking Settings"

Track		: Perform Auto Pointing and Tracking when measuring the distance
•Search		: Perform only Auto Pointing when measuring the distance
None		: Measure the distance only
TRK On		: Start Auto Tracking. "TRK Off" is displayed when performing Auto Tracking or when in "Prism wait" status. Tap to quit Auto Tracking.
Search		: Begin searching
INV		: Rotates the instrument 180°
Go to Search/Track config.		

One of the following icons will be displayed while the motor is in operation to indicate the current status of the instrument.

	: Rotating
	: Rotating at fixed velocity
	: Searching/Searching after target lost during Auto Tracking
	: Auto Tracking in progress
	: Auto Tracking idle (when Auto Tracking set)
	: Auto Tracking in predicted direction
	: Waiting for prism during Auto Tracking

Predicted direction and waiting for prism: "10.1 Auto Pointing and Auto Tracking Settings" Lost Prism"

## Note

- Auto Tracking and Auto Pointing cannot be performed when "Reflectorless" has been selected as the target type ( will be displayed). Auto Tracking cannot be performed when "Sheet" has been selected as the target type ( will be displayed).
- An arrow indicating turn direction will be displayed when the instrument is rotating at a fixed velocity.

## (4) Laser-pointer/guide light icon

Selection of laser-pointer/guide light status.

Switching the laser-pointer/guide light ON/OFF: "5.1 Basic Key Operation"

You can jump to the Instrument config. screen.

"19.7 Instrument Conditions - Instrument"

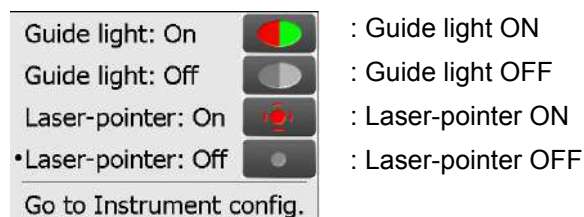

## Note

- The laser-pointer will be automatically switched OFF during distance measurement.

## (5) Tilt angle compensation icon

The vertical and horizontal angles are automatically compensated for small tilt errors using the dual-axis tilt sensor.

Selection of tilt function condition.

You can display <Tilt> or jump to the Angle/tilt config. screen.

<Tilt>: "7.2 Levelling"

Setting of tilt angle compensation: "19.1 Observation Conditions - Angle/Tilt"

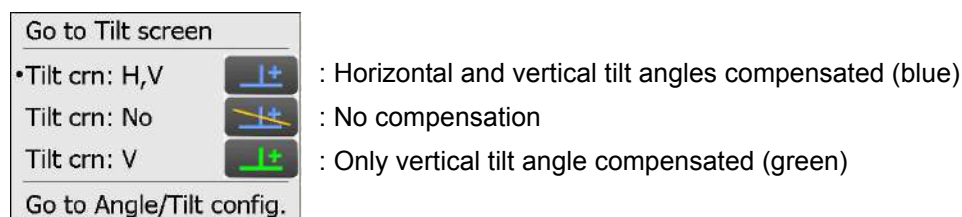

## Note

- is displayed when the instrument is out of level.

## (6) Communication status with external devices icon

Selection of communication method with external devices.

You can jump to the Communication config. screen.

Setting of RS232C communication: "9.3 Connection via RS232C Cable"

Setting of *Bluetooth* communication: "9.1 Wireless Communication using Bluetooth Technology"

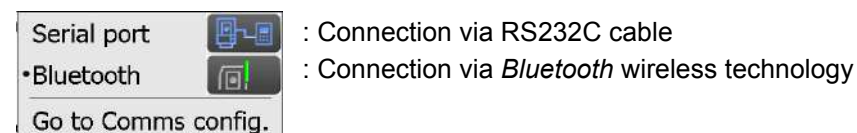

Connection status to external devices is displayed as follows.

i) Connection via *Bluetooth* wireless technology

: Connecting



: Canceling connection



: (Antenna is moving) Inquiring about other *Bluetooth* devices



: (Antenna is stationary) Communication settings in progress/Preparing for communication (Instrument just powered ON etc.)



: Connection error (icon flashes)

## ii) Connection via RS232C cable



: RS232C is selected



: Sending data from a data collector to iX



: Sending data from iX to a data collector



: Exchanging data in both directions between iX and a data collector

## Note

- A red arrow indicates that data transmission has failed and data needs to be sent again.

## (7) Input mode icon

Selection of input mode

_1	Inputting numbers and symbols
_a	Inputting lower case alphabetic characters
_A	Inputting upper case alphabetic characters

"5.1 Basic Key Operation ● Inputting letters/figures"

## (8) Input panel icon

"5.3 Inputting Characters using the Input Panel"

## (9) PPM setting icon

Current atmospheric correction factor setting is displayed.

You can jump to the Atmos config. screen.

"19.4 Observation Conditions - Atmosphere"

[Go to Atmos config.](#)

## (10) Internet communication status

Connection status of internet communication is displayed.

You can jump to the Internet config. screen.

"9.4 Wireless LAN Settings and Communication"

"9.5 Cellular Settings and Communication"

Configuration of internet communication.

[Go to Internet config.](#)

Connection status to a router is displayed as follows.

## i) Wireless LAN connection



: Disconnected/Intensity of signal less than -91 (dBm)



: Intensity of signal -90 to -70(dBm)



: Intensity of signal -71 to -68(dBm)



: Intensity of signal -67 to -58(dBm)



: Intensity of signal more than -57 (dBm)

## ii) Cellular connection



: Connected



: Disconnected

## (11) Config mode icon

Jump to Config mode.

 "19. CHANGING THE SETTINGS"

## (12) Touch panel icon

De-activate the touch panel temporarily.

You can jump to the Display config. screen.

 "19.5 Instrument Conditions - Display"

Touch panel temporarily de-activated 	: Touch panel temporarily de-activated.
Go to Display config.	

 Note

- This icon cannot be operated during distance measurement, or during data transmission.

## (13) Disk usage icon

The status of the disk (memory) of the instrument is displayed.

 : Less than 20%

 : 20 to 50%

 : More than 50%

Tap and hold disk icon in the Status icon to check the detail of the disk usage.

Internal disk		
Used space	102828KB	:Usage space of disk capacity of the instrument
Free space	410596KB	:Free space of disk capacity of the instrument
Capacity	513424KB	:Disk capacity of the instrument
Removable Disk		
Used space	213776KB	:Usage space of disk capacity of the external disk connected to the instrument
Free space	3724976KB	:Free space of disk capacity of the external disk connected to the instrument
Capacity	3938752KB	:Disk capacity of the external disk connected to the instrument



- Information about Removable Disk is displayed only when an external disk is connected to the instrument and a program on the Program mode is activated.

# 6. USING THE BATTERY

## 6.1 Battery Charging

The battery was not charged at the factory. Charge the battery fully before using the instrument.



- The charger will become rather hot during use. This is normal.
- Do not use to charge batteries other than those specified.
- The charger is for indoor use only. Do not use outdoors.
- Batteries cannot be charged, even when the charging lamp is flashing, when the temperature is outside the charging temperature range.
- Do not charge the battery just after charging is completed. Battery performance may decline.
- Remove batteries from the charger before putting into storage.
- When not in use, disconnect the power cable plug from the wall outlet.
- Store the battery in a dry room where the temperature is within the following ranges. For long-term storage, the battery should be charged at least once every six months.

Storage period	Temperature range
1 week or less	-20 to 50°C
1 week to 1 month	-20 to 45°C
1 month to 6 months	-20 to 40°C
6 months to 1 year	-20 to 35°C

- Batteries generate power using a chemical reaction and as a result have a limited lifetime. Even when in storage and not used for long periods, battery capacity deteriorates with the passage of time. This may result in the operating time of the battery shortening despite having been charged correctly. In this event, a new battery is required.

### PROCEDURE

1. Connect the power cable to the charger and plug the charger into the wall outlet.
2. Mount the battery in the charger by matching the grooves on the battery with the guides on the charger.

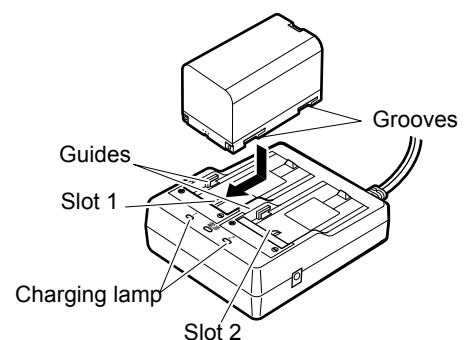

3. When charging starts, the lamp starts blinking.
4. The lamp lights when charging is finished.
5. Remove the battery and unplug the charger.

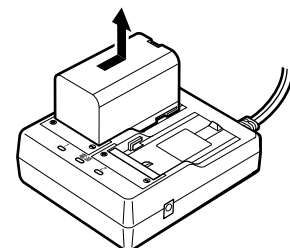





- Slots 1 and 2:  
The charger starts charging the battery mounted first. If you place two batteries in the charger, the battery in slot 1 is charged first, and then the battery in slot 2. (☞ step 2)
- Charging lamp:  
The charging lamp is off when the charger is outside the charging temperature range or when the battery is mounted incorrectly. If the lamp is still off after the charger falls within its charging temperature range and the battery is mounted again, contact your local dealer. (☞ steps 2 and 3)
- Charging time per battery:  
BDC70: about 5.5 hours (at 25°C) (Charging can take longer than the times stated above when temperatures are either especially high or low).

## 6.2 Installing/Removing the Battery

Mount the charged battery.

☞ Type of power source: "23. POWER SUPPLY SYSTEM"



- Use the attached battery (BDC70).
- Before removing the battery, turn off the power to the instrument. If the battery is removed while the power is switched on, a warm boot may occur. File and folder data may be lost as a result.
- Do not open the battery cover while the power is on.
- Do not damage the projected sensor inside the battery cover. Also, be careful not to shut the battery cover on your fingers.
- When installing/removing the battery, make sure that moisture or dust particles do not come in contact with the inside of the instrument.
- Remove batteries from the surveying instrument or charger before putting into storage.

### PROCEDURE Mounting the battery

1. Slide down the catch on the battery cover to open.

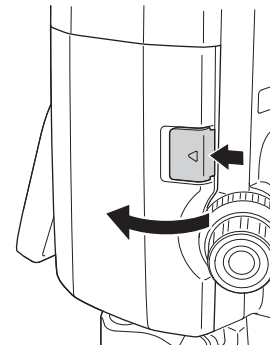

2. Checking the terminal side on the battery, insert the battery as shown.



- Do not insert the battery inclined. Doing so may damage the instrument or battery terminals.

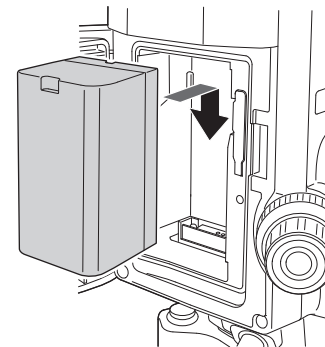

3. Close the battery cover. A click is heard when the cover is secure.

# 7. SETTING UP THE INSTRUMENT



- Mount the battery in the instrument before performing this operation because the instrument will tilt slightly if the battery is mounted after levelling.

## 7.1 Centering

### PROCEDURE Centering with the optical plummet eyepiece

1. Make sure the legs are spaced at equal intervals and the head is approximately level.  
Set the tripod so that the head is positioned over the survey point.  
Make sure the tripod shoes are firmly fixed in the ground.

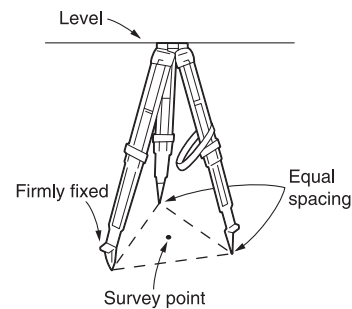

2. Place the instrument on the tripod head.  
Supporting it with one hand, tighten the centering screw on the bottom of the unit to make sure it is secured to the tripod.

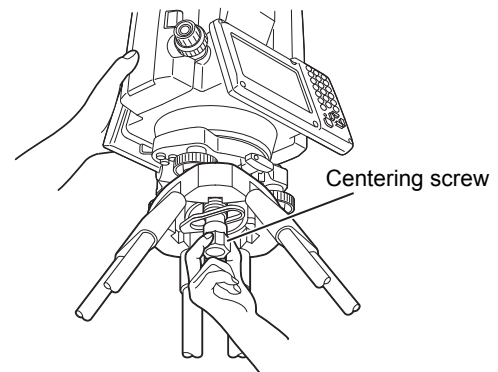

3. Looking through the optical plummet eyepiece, turn the optical plummet eyepiece to focus on the reticle.  
Turn the optical plummet focussing ring to focus on the survey point.

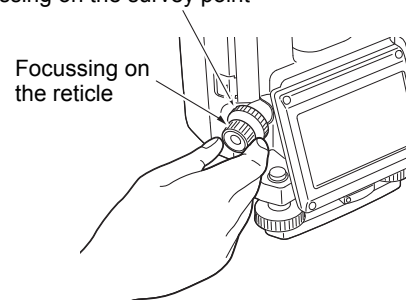

4. Adjust the levelling foot screws to center the survey point in the optical plummet reticle.

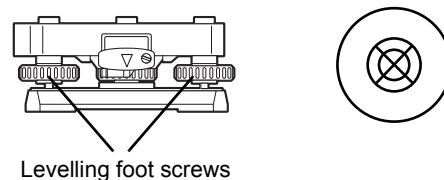

### PROCEDURE Centering with the laser plummet eyepiece (Optional accessory)

1. Set up the tripod and affix the instrument on the tripod head.  
☞ "7.1 Centering"

- Power ON the instrument.

☞ "8. POWER ON/OFF"

The electric circular level is displayed on the <Tilt>.

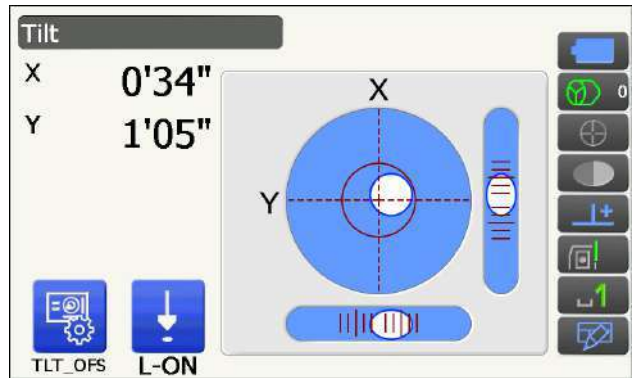

- Press **[L-ON]**.

The laser plummet beam will be emitted from the bottom of the instrument.

- Use **{◀/▶}** in the second page to adjust the brightness of the laser.

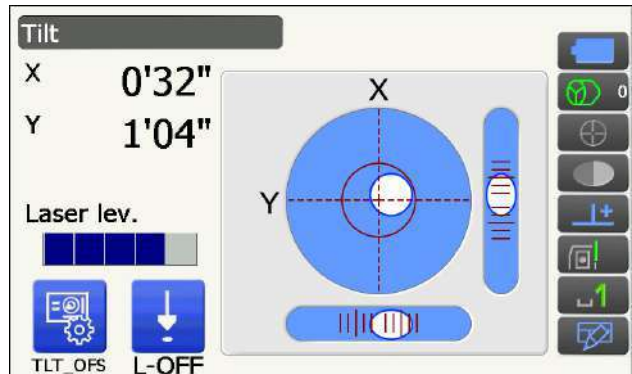

- Using levelling foot screws, adjust the position of the instrument on the tripod until the laser beam is aligned with the center of the survey point.
- Press **[L-OFF]** to turn the laser plummet off. Alternatively, the laser plummet will switch off automatically when going to another screen.

#### Note

- Visibility of the laser spot may be affected when operating in direct sunlight. In this event, provide shade for the survey point.

## 7.2 Levelling

### PROCEDURE

- Perform the centering procedure.  
☞ "7.1 Centering"
- Roughly center the bubble in the circular level by either shortening the tripod leg closest to the offcenter direction of the bubble or by lengthening the tripod leg farthest from the offcenter direction of the bubble. Adjust one more tripod leg to center the bubble.

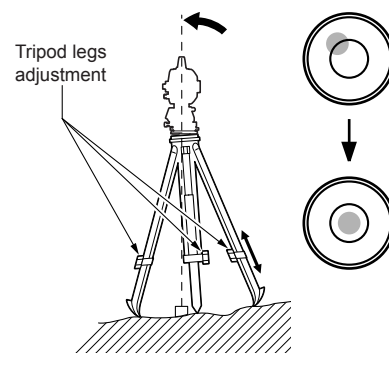

3. Power ON the instrument.

 "8. POWER ON/OFF"

The electric circular level is displayed on the <Tilt>. "●" indicates the bubble in circular level. The range of the inside circle is  $\pm 1.5'$  and the range of the outside circle is  $\pm 6'$ .

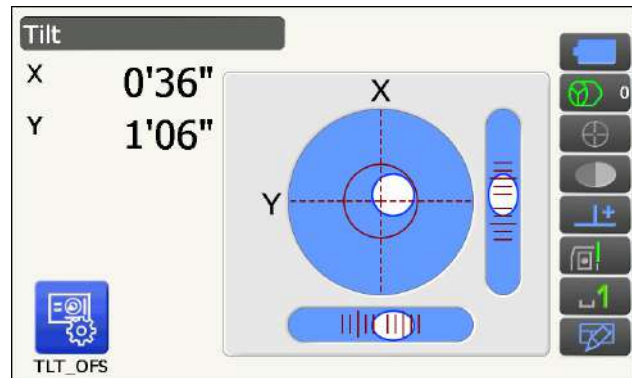

4. Using levelling foot screws, center "●" in the circular level.

First, turn the instrument until the telescope is parallel to a line between levelling foot screws A and B. Next, set the tilt angle to  $0^\circ$  using foot screws A and B for the X direction and levelling screw C for the Y direction.

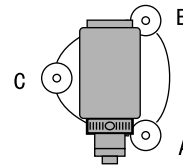

- When the bubble is in the center, proceed to step 5.

5. Loosen the centering screw slightly.

Looking through the optical plummet eyepiece, slide the instrument over the tripod head until the survey point is exactly centered in the reticle.

Retighten the centering screw securely.

If the instrument is levelled using laser plummet, emit the laser plummet beam and check it again.

 "7.2 Levelling PROCEDURE Centering with the laser plummet eyepiece (Optional accessory)"

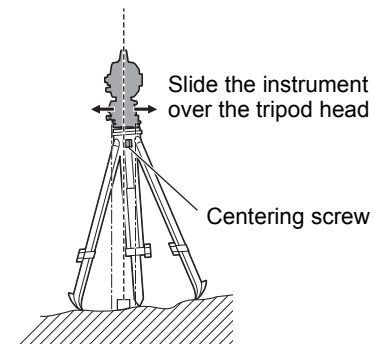

6. Check again to make sure the bubble in the electric circular level is centered.

If not, repeat the procedure starting from step 4.

7. Press **{ESC}** to return to Observation mode.

# 8. POWER ON/OFF



- When the power cannot be switched ON or the power is soon turned OFF even though the battery is mounted, there may be almost no battery power remaining. Replace it with a fully charged battery.  
☞ "20. WARNING AND ERROR MESSAGES"

## PROCEDURE Power ON

1. Press the power key on the side of the instrument.

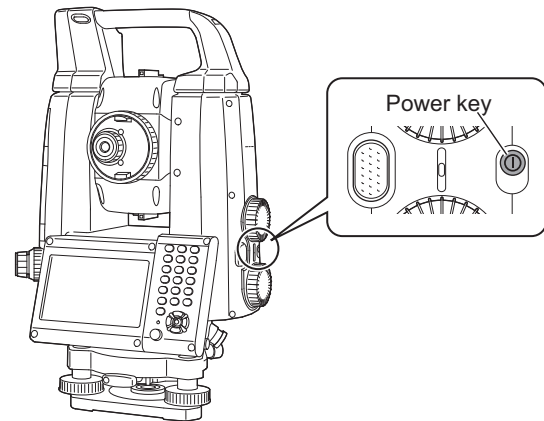

When the power is switched on, <Tilt> is displayed.

☞ "7.2 Levelling" step 3

Press {ESC} to go Observation mode screen.

If "Out of range" is displayed, the instrument tilt sensor is indicating that the instrument is out of level. Level the instrument once again using circular level, then display <Tilt>.

Press and hold  on Status icon or in Starkey mode, then select "Go to Tilt screen".

☞ "5.4 Starkey Mode" (5) Tilt angle compensation icon

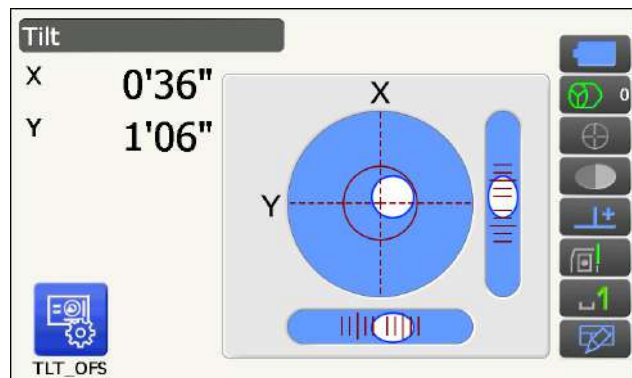

- "Tilt crn." in <Angle/Tilt> should be set to "No" if the display is unsteady due to vibration or strong wind.  
☞ "19.1 Observation Conditions - Angle/Tilt"



### Resume function

The Resume function redisplay the screen appearing before the instrument was powered OFF when the instrument is powered back ON. All parameter settings are also saved. Even if remaining battery power is completely depleted, this function will remain active for 1 minute, after which it is canceled. Replace a depleted battery as soon as possible.

## PROCEDURE Power OFF

1. Press and hold (about 1sec) the power key on the side of the instrument.



- When there is almost no battery power remaining, the battery icon in the Status icon will start to blink. In this event, stop measurement, switch off the power and charge the battery or replace with a fully charged battery.
- To save power, power to the instrument is automatically cut off if it is not operated for a fixed period of time. This time period can be set in "Power off" in <Power supply>.
  - ☞ "19.6 Instrument Conditions - Power"
- It takes about 5 seconds to turn OFF the power.

### 8.1 Configuring the Touch Panel

When using for the first time, or after performing a cold boot, the screen for configuring the touch panel will be displayed.

Follow the instructions on the screen and tap the cross-hairs displayed on the screen with the stylus pen.

Tap the cross-hairs on the other side of the display as well. (For the model with display on the both sides only).

Carefully press and briefly hold stylus  
on the center of the target.  
Repeat as the target moves around the screen.  
Press the Esc key to cancel.



#### Note

- Touch panel configuration can be performed at any time during normal operation by pressing **[PNL CAL]** in <Display>.
  - ☞ "19.5 Instrument Conditions - Display"

### 8.2 Resolving Software Issues

If you are experiencing problems with the instrument and suspect a fault in the program, you should try a warm boot. If the problem is not resolved with a warm boot the next step is to perform a cold boot. A warm boot will not erase surveying data in the instrument but will cancel the resume function. Whenever possible transmit the data to a personal computer before rebooting.

## PROCEDURE

1. Power OFF the instrument.
2. Press the power key on the side of the instrument while pressing **{Enter}**.  
The instrument is reset and powers ON as normal.

### Cold boot

If the problem is not resolved with a warm boot the next step is to perform a cold boot. A cold boot will not erase surveying data in the instrument but all the parameters will be changed to the factory settings. If the data in the memory is necessary, **BE SURE TO TRANSFER IT TO A PERSONAL COMPUTER BEFORE PERFORMING A COLD BOOT.**

To perform a cold boot, while holding {☀}, and {S.P.}, press the power key on the side of the instrument. The instrument is reset and powers ON as normal.

 "19.14 Restoring Default Settings"

### Problems Powering OFF

When the instrument cannot be powered OFF as normal, depress the reset button with the tip of the stylus pen.



- Pressing the Reset button may result in file and folder data being lost.

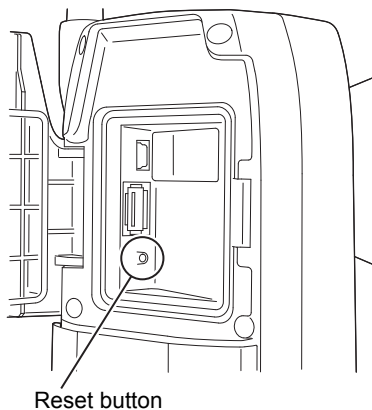



## 8.3 Powering ON/OFF from an External Instrument

The instrument can be powered ON/OFF from an external device such as a computer or data collector.



- The password must be input after powering ON the instrument from an external device when a password has been set.

 Remote PWR-On function: "19.7 Instrument Conditions - Instrument"

 Setting a password: "19.9 Instrument Conditions - Password"

# 9. CONNECTING TO EXTERNAL DEVICES

The instrument supports *Bluetooth* wireless technology and RS232C for communication with data collectors etc. As for internet connection, Wireless LAN and SIM are supported. Inputting/outputting data is possible by inserting a USB flash drive or by connecting to a USB device. Read this manual in conjunction with the operator's manual for the relevant external device.



- When doing *Bluetooth* communication, read "4.3 Bluetooth Wireless Technology/Wireless LAN".

## 9.1 Wireless Communication using *Bluetooth* Technology

The *Bluetooth* module incorporated in the instrument can be used for communication with *Bluetooth* devices such as data collectors.



### **Bluetooth connection mode**

Communication between a pair of *Bluetooth* devices requires one device to be set as the "Master" and the other as the "Slave". iX is always "Slave" and the paired data collector will be the "Master" when performing measurements and recording the data between them.

### PROCEDURE Setting for *Bluetooth* communication

1. Select "Comms" in Config mode.

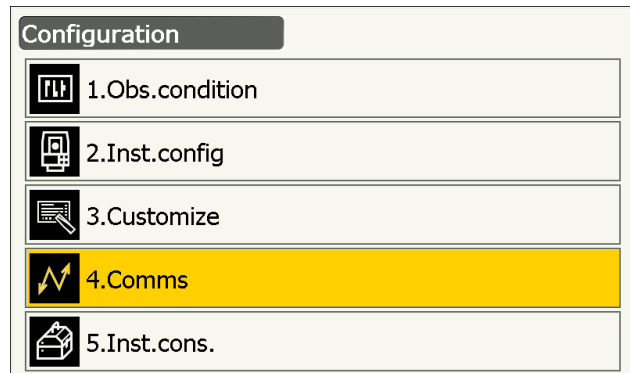

2. Select "Comms mode" in <Communication Setup>.

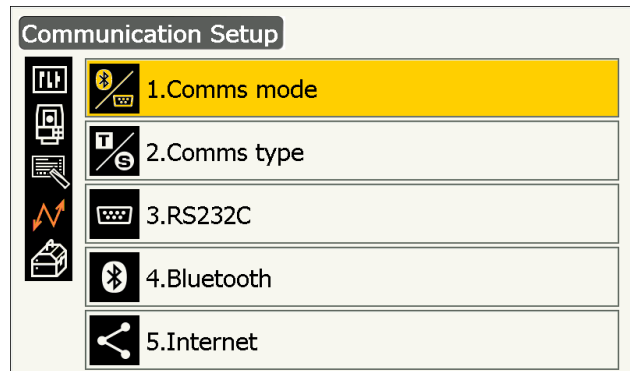

3. Set "Comms mode" to "*Bluetooth*".

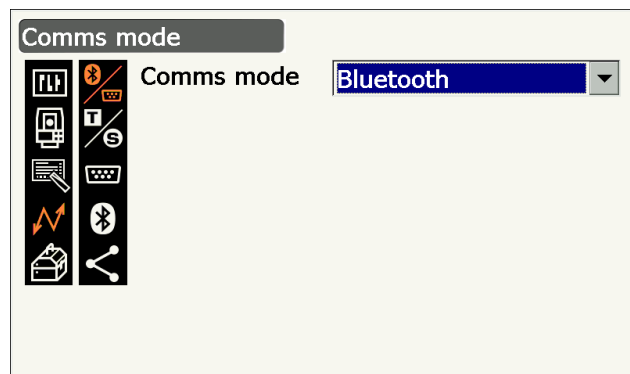



4. Select "Comms type" in <Communication Setup>.

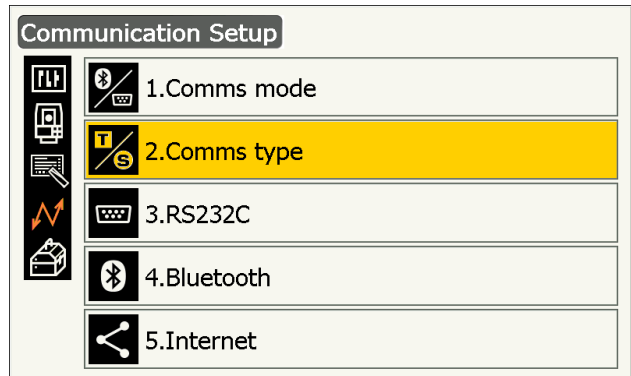

5. Select "S-Type".



- "T-Type" is for an instrument using GTS commands.

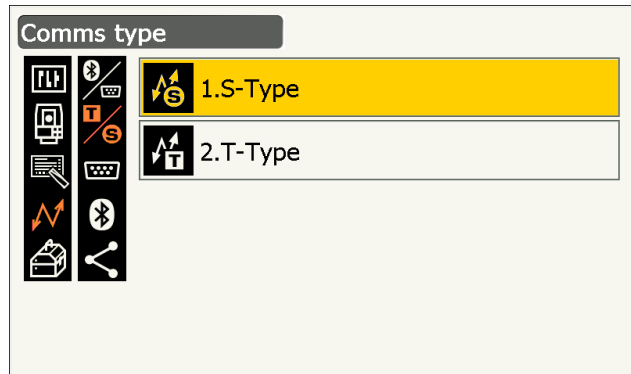

6. Perform communication settings for S-type.  
**Items set and options (\*: Factory setting)**

- (1) Check sum : Yes/No\*
- (2) Controller : Remote/2 Way/2 Way+Remote\*



- Changing communication settings during *Bluetooth* communication will cancel the connection.
- No changes for the factory setting are necessary as long as connecting to a recommended program on the data collector. If connection can not be established, check the communication settings of iX and the data collector.

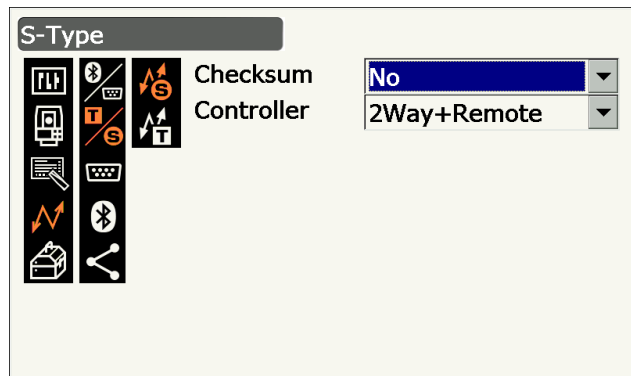

7. Select "*Bluetooth*" in <Communication Setup>.

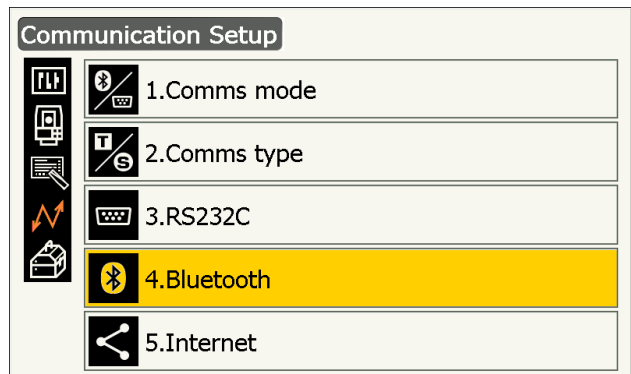

8. Set "Authentication" to "Yes" or "No".  
If "Authentication" is set to "Yes", the passkey will also need to be input on the companion device.



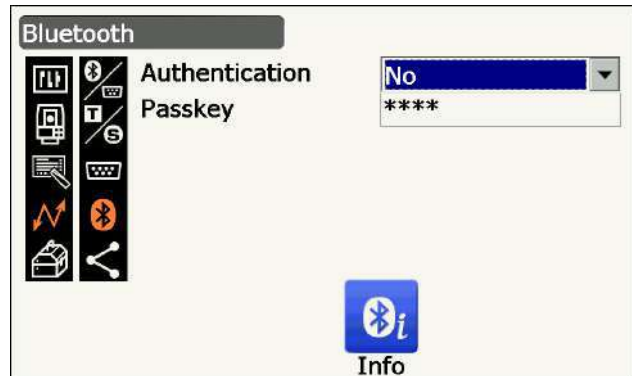

9. When "Authentication" is set to "Yes", input the same passkey as that for the intended companion device. Even if "Authentication" is set to "No", a passkey is requested when authentication is set on the companion device being used.

- Up to 16 numeral characters can be input. Input characters will be displayed as asterisks (e.g. "\*\*\*\*\*"). The passkey was set to "0123" at the factory.



10. Press **{Enter}** to finish settings. Move on to the *Bluetooth* communication.  
☞ "9.2 Communication between the iX and Companion Device"

#### Note

- When selecting "T-type" in step 3, the following items are displayed.
  - (1) REC Type  
REC-A\* (newly measured data is output)/REC-B (displayed data is output)
  - (2) Terminate   
ETX\*/ETX+CR/ETX+CR+LF
  - (3) TRK State  
On (with track state information)/Off\*
  - (4) Ack mode   
On\*/Off



#### Terminate

Select the option Off or On for carriage return (CR) and line feed when collecting measurement data with a computer.



#### ACK mode

When communicating to an external device, the protocol for handshaking can omit the **[ACK]** coming from the external device so data is not sent again.

On: Standard

Off: Omit the **[ACK]**

**PROCEDURE Displaying *Bluetooth* information for the iX**

1. Press **[Info]** in *<Bluetooth>* to display information for the iX.

☞ "9.1 Wireless Communication using Bluetooth Technology PROCEDURE Setting for Bluetooth communication"

Register the *Bluetooth* address (BD ADDR) displayed here in the paired device set as "Master".

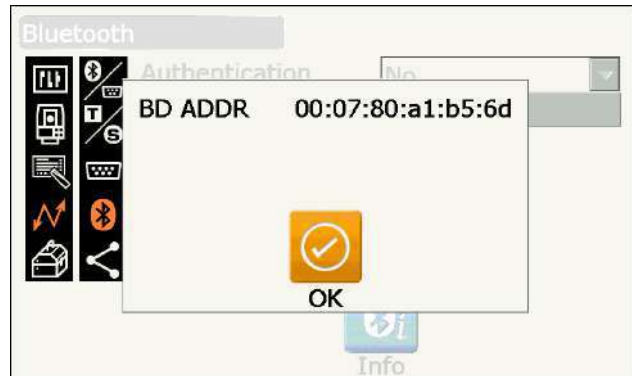

2. Press **{Enter}** to return to *<Bluetooth>*.

### **Bluetooth device address**

This is a number unique to one particular *Bluetooth* device used to identify devices during communication. This number consists of 12 characters (numbers 0 to 9 and letters from A to F).

Some devices may be referred to by their *Bluetooth* device address.

## 9.2 Communication between the iX and Companion Device



- *Bluetooth* communication causes instrument battery power to be depleted at a rate higher than that for normal operation.
- Check that the companion device (data collector, computer, or cellular phone etc.) is turned on and the relevant *Bluetooth* settings are complete.
- All communication settings will be changed to factory settings when a cold boot is performed. Comms setup will need to be performed again.

☞ "9.1 Wireless Communication using Bluetooth Technology"

**PROCEDURE**

1. Complete the necessary iX settings for *Bluetooth* communication.

☞ "9.1 Wireless Communication using Bluetooth Technology PROCEDURE Setting for Bluetooth communication"

2. Start communication by the data collector.

☞ Manual of the program mounted on the data collector

When a connection has been successfully established,  is displayed.



3. Terminate the connection by the data collector.

### 9.3 Connection via RS232C Cable

RS232C communication is possible, connecting instrument and a data collector with the cable.

#### PROCEDURE Basic cable settings

1. Power OFF the instrument and connect the instrument and a data collector with a interface cable.

 Cables: "25. ACCESSORIES"



- Insert the interface cable to the serial/external power source connector tightly and then turn it.

2. Select "Comms" in Config mode.

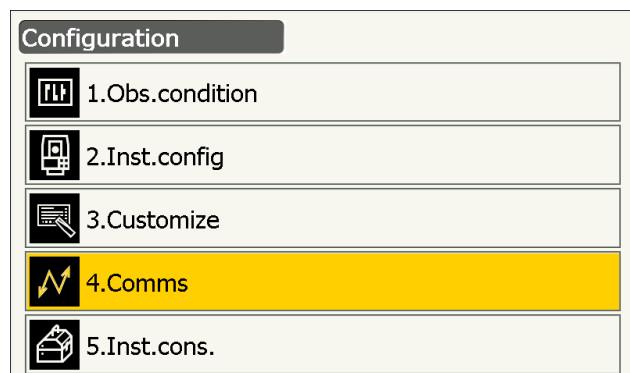

3. Select "Comms mode" in <Communication Setup>.

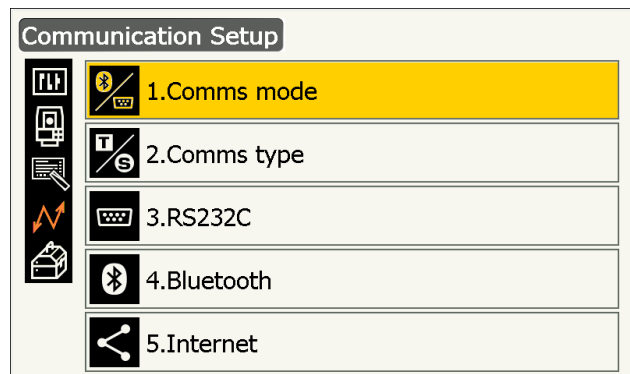

4. Set "Comms mode" to "RS232C".

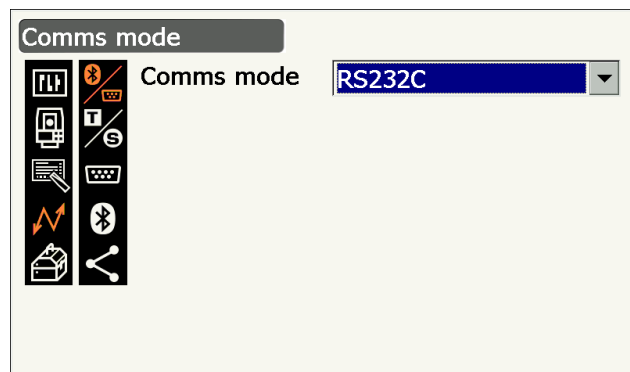

5. Select "RS232C" in <Communication Setup>.

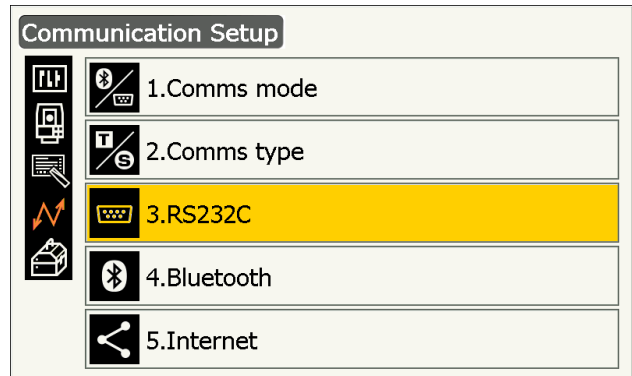

6. Perform communication setting for RS232C.

**Items set and options (\*: Factory setting)**

- (1) Baud rate : 1200/2400/4800/9600\*/19200/38400bps
- (2) Data bits : 7/8\* bits
- (3) Parity : Not set\*/Odd/Even
- (4) Stop bit : 1\*/ 2 bits

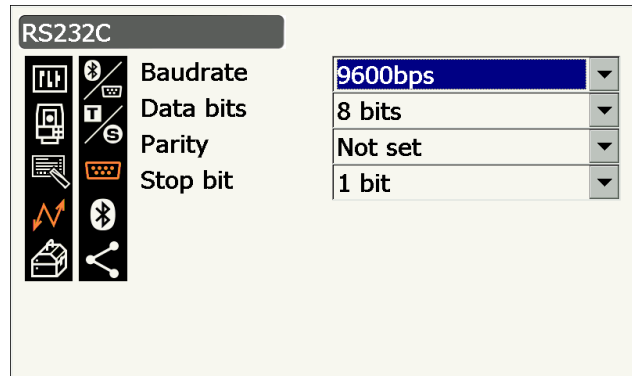

7. Press {Enter} to finish settings.

## 9.4 Wireless LAN Settings and Communication

A program installed on the instrument can communicate with an external device by connecting to Internet via Wireless LAN.

### PROCEDURE

1. Select "Comms" in Config mode.

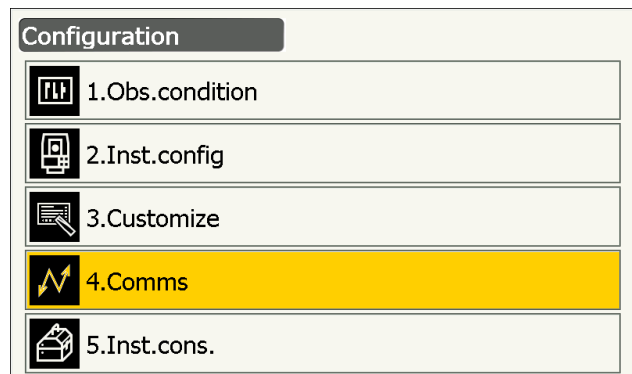

2. Select "Internet" in <Communication Setup>.

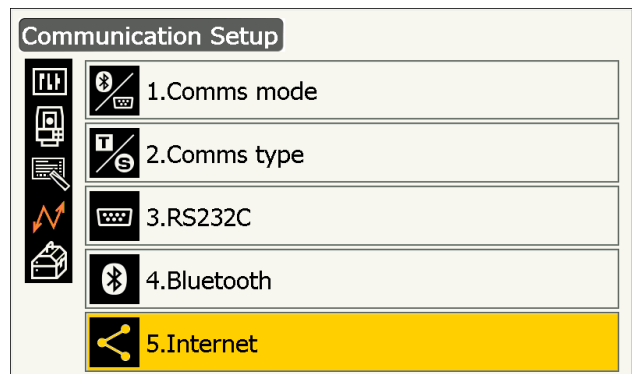

3. Set "Connection" to "WLAN" in <Internet>.
4. Set "IP Settings" to "Auto" when obtaining an IP address via DHCP server.

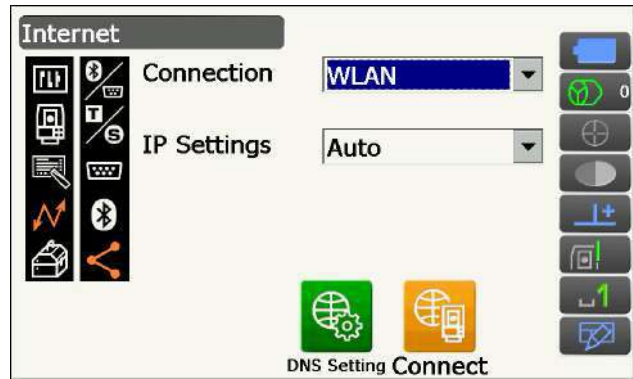

- Set "IP Settings" to "Static" when specifying an IP address and set related items.

#### Items set

- (1) IP Address  
(IP address connectable to a router. Input the IP address so that it is not the same of the router to be connected. (Avoid the overlapped range of IP address assigned via DHCP server))

Example:

Set 192.168.0.3 when the router address is 192.168.0.1.

- (2) Subnet Mask  
(The same value of the router to be connected)
- (3) Gateway  
(IP address of the router to be connected)



5. Press **[DNS Setting]** in <Internet>.  
Set "DNS Setting" to "Auto" when using a server address assigned via a name server and then press **[OK]**.

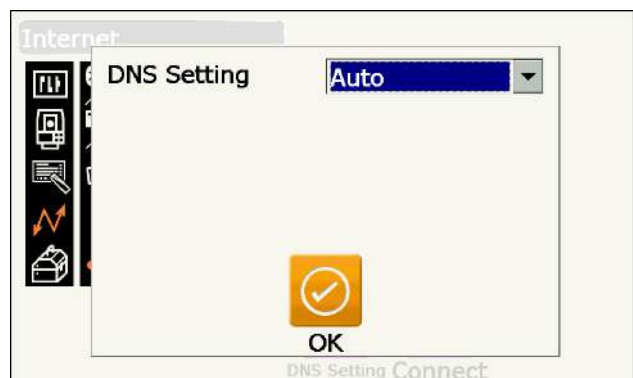

- Set "IP Settings" to "Static" when it is necessary to specify a DNS server address manually using the information given from your internet service provider. Set related items and press **[OK]**.

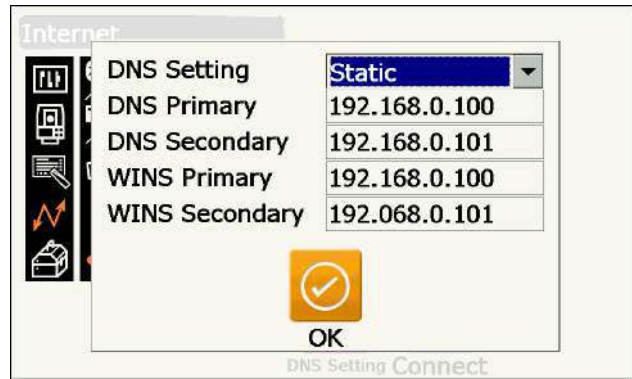

**Items set**

- (1) DNS Primary  
(IP address of DNS primary server)
- (2) DNS Secondary  
(IP address of DNS secondary server)
- (3) WINS Primary  
(IP address of WINS primary server)
- (4) WINS Secondary  
(IP address of WINS secondary server)

6. Press **[Connect]** in <Internet> to move to the communication setting screen.

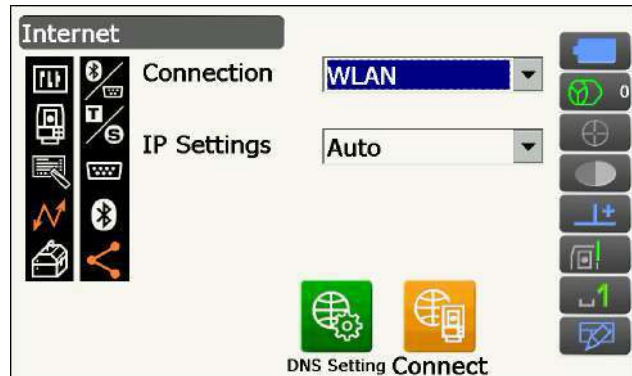

7. Select an access point from the searched Wireless LAN access points and press **[Connect]**.

**Note**

- It may take a few seconds until wireless LAN access points list is displayed.

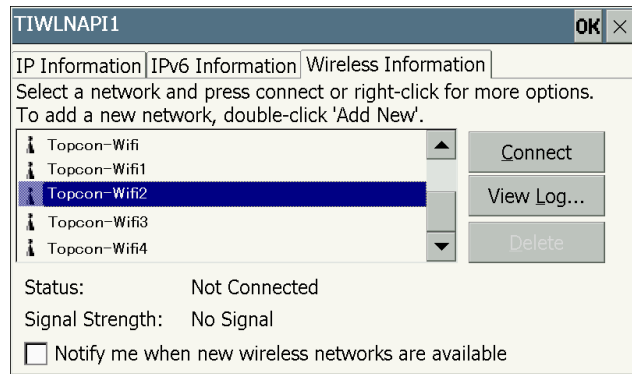

8. Set necessary security settings for the Wireless LAN connection in <Wireless Network Properties> and press **[OK]**.

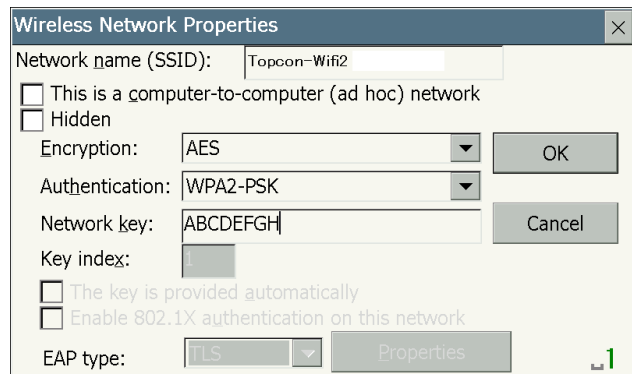

- Check the connection status in Wireless Information screen. Press **[OK]** to return to <Internet>.

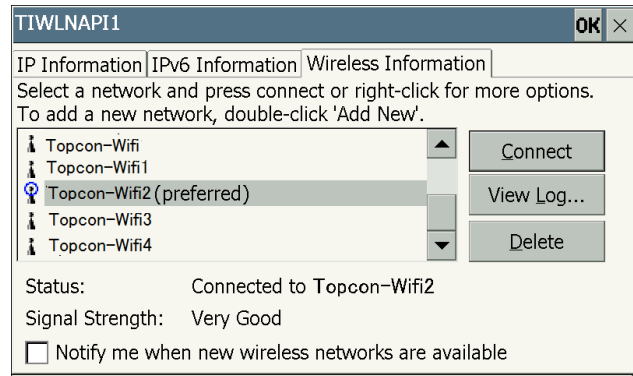

A program installed on the instrument can now communicate with an external device.

- Press **[Disconnect]** to terminate the connection.
- Press **[Confirm]** to display Wireless Information screen and check the access point setting.



**DNS server and WINS server**

Domain Name Servers (DNS) are server which resolve a domain name (www.aaa.com etc.) to an IP address and vice versa.

Windows Internet Name Service (WINS) is a server which resolves a computer name on Windows Network to an IP address and vice versa.

Secondary servers for each server are available to resolve IP address in case of a server system down.

**9.5 Cellular Settings and Communication**

A program installed on the instrument can communicate with an external device by connecting to Internet via Cellular connection.



- SIM card may not be used depending on the model, the country or the area where the instrument is purchased.
- Some SIM cards may not be used depending on the carriers or the contact details with the carrier.
- IMEI (International Mobile Equipment Identity) may be necessary when activating your SIM card. Check the IMEI in the screen of step 6.
- Disable the PIN code on your SIM card before using.
- After powering ON, it is necessary to wait about 5 minutes until cellular communication is ready. The message on the right is displayed before the cellular communication is ready.





**PROCEDURE**

1. Open the battery cover.  
☞ "6.2 Installing/Removing the Battery"
2. Insert a SIM card to the SIM card slot.



- Do not use SIM card converter adaptor. Inserted adaptor may not be taken out or it may damage the inside of the SIM card slot.

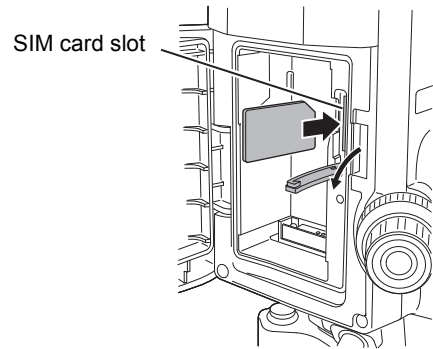

3. Close the battery cover.
4. Select "Comms" in Config mode.

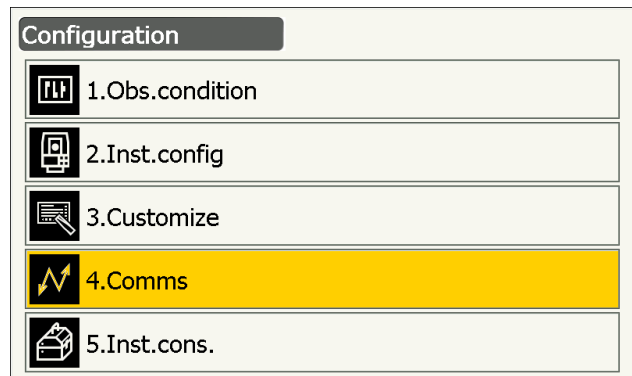

5. Select "Internet" in <Communication Setup>.

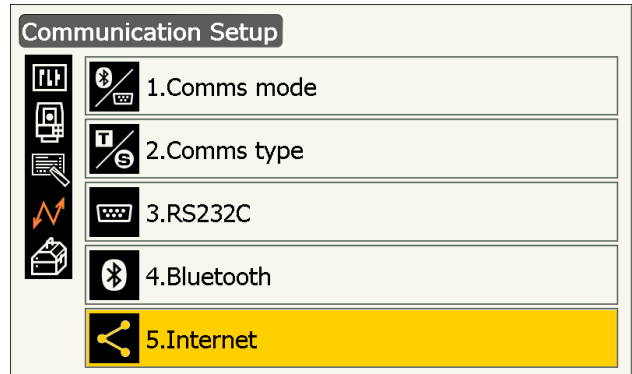

6. Set "Connection" to "Cellular2" in <Internet> and set the information of your carrier to connect.

**Items set**

- (1) Dial Number  
(\*99# or \*99\*\*\*1#)
- (2) APN  
(Access point name provided from your carrier)
- (3) User Name  
(User name provided from your carrier)
- (4) Password  
(Password provided from your carrier)
- (5) Authentication  
No/PAP/CHAP



• When IMEI is necessary for the activation of your SIM card, check the IMEI displayed in this screen.

7. Press **[Search]** to search connection-ready carriers in the immediate vicinity of the instrument. Select the carrier set in step 6 and press **[OK]**.

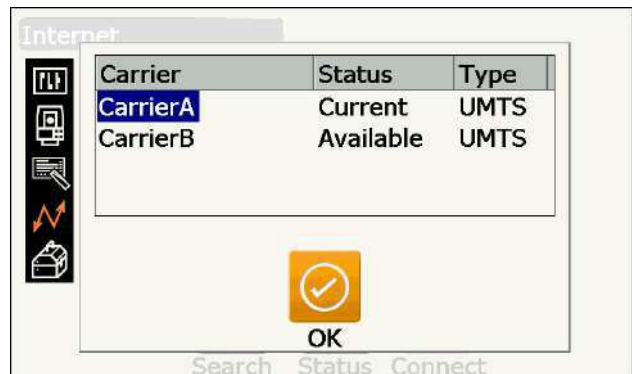

• Press **[Status]** to display the communication status. Displayed items are as follows.

- Carrier Name : Selected carrier's name
- Level : Connection status is displayed in 5 levels
- Check1 : OK/-
- Check2 : OK/-
- Connection : OK/NG



• "Carrier Name" and "Check1" may not be displayed even when connection is correctly established.

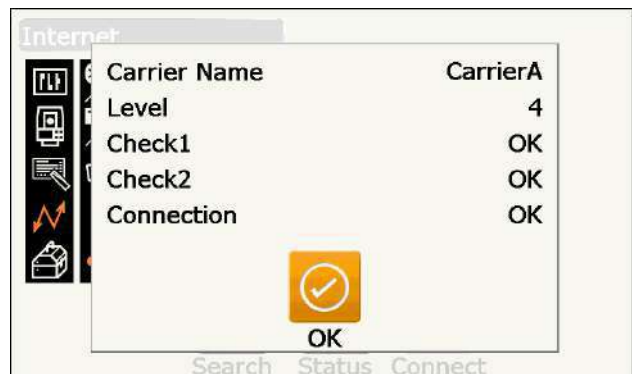

8. Press **[Connect]** in <Internet> to start communication.



A program installed on the instrument can now communicate with an external device.

- Press **[Disconnect]** to terminate the connection.



- When you can not access the internet after the series of steps for connection, check the Dial Number. If a wrong dial number is input, internet connection is not available.



## 9.6 Connecting via USB Cable

Using USB port 2, the instrument and a computer can be communicated. There are USB mode and Mobile mode.

### USB port

The instrument has two different USB ports. Each port is used for connection to different types of devices.

Port name	Device type
USB port 1	USB flash drive
USB port 2 (mini-B)	computers etc.

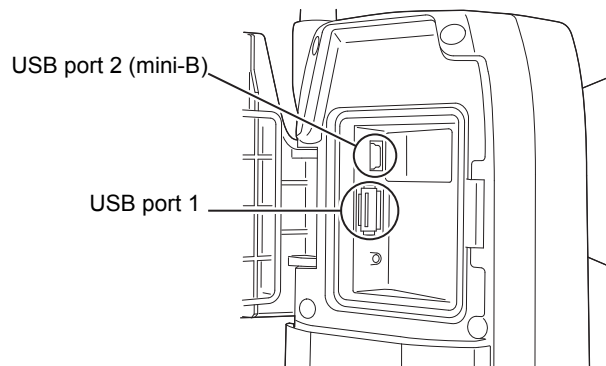

- TOPCON CORPORATION cannot guarantee that all USB devices are compatible with the iX USB ports.
- Use a computer WindowsVista/7 is based and USB connection is capable.
- Remove the USB cable from USB port 2 carefully to avoid damaging the cable.

**Note**

- As for the download and install of "exFat file system driver"/ActiveSync/Windows Mobile Device Center, please access to Microsoft support site.

### PROCEDURE Connecting the instrument to a computer to transfer data from instrument in USB mode

1. Slide up the catch on the external interface hatch to open.

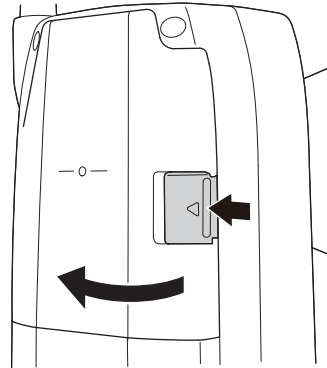

2. Power OFF the instrument. Connect the USB port 2 on the instrument and computer using the USB cable.

 "8. POWER ON/OFF"

**Note**

- The computer does not need to be turned OFF before connection.

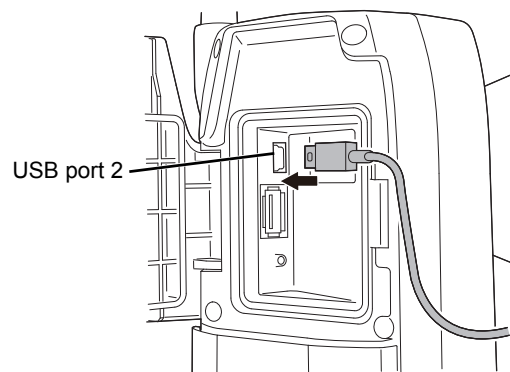

3. Press the power key on the side of the instrument while pressing **{Enter}** to display a message box asking whether to boot USB mode, then press **[YES]**.

The screen of the instrument will be <USB Mode>.

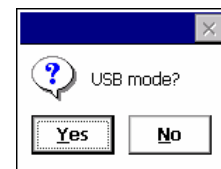
**Note**

- instrument may not be displayed as <Removable Disk>. It depends on Windows settings.



Follow the instructions below to ensure that the instrument continues to operate normally during USB transfer.

- Do not change the folder hierarchy or folder names in <Removable Disk>.
- Do not format the "removable disk" on the computer.

4. Perform "Safely Remove Hardware"  in the task bar and disconnect the USB cable.

5. Press the power key and hold (about 1sec) to turn off the instrument to exit USB mode connection.

## PROCEDURE Connecting the instrument to a computer to transfer data from instrument in Mobile mode

A synchronous software needs to be installed to the computer depending on the Windows version.

Computer to connect	Synchronous software
Windows vista/7	Windows Mobile Device Center

- Slide up the catch on the external interface hatch to open.
- Power OFF the instrument. Connect the instrument and computer using the USB cable.  
☞ "8. POWER ON/OFF"

### Note

- The computer does not need to be turned OFF before connection.

- Press the power key while pressing **{Enter}** to display a message box asking whether to boot USB mode, then press **[NO]**.  
The synchronous software is effective.



### Note

- instrument may not be displayed as <Removable Disk>. It depends on Windows settings.



Follow the instructions below to ensure that the instrument continues to operate normally during USB transfer.

- Do not change the folder hierarchy or folder names in <Removable Disk>.
- Do not format the "removable disk" on the computer.

- If synchronous software displays a partner setting screen on the computer and asks whether to set a partner device, press **[NO]**.

### Note

- A partner setting screen may not be displayed depending on the synchronous software settings.

- Disconnect the USB cable to exit mobile mode connection.

## 9.7 Inserting USB Flash Drive

Saving data in a USB flash drive or importing data from a memory is possible using the particular program on Program mode.

☞ USB ports: "9.6 Connecting via USB Cable ☞ USB port"



- When reading/writing data, do not remove the USB flash drive.

### PROCEDURE

1. Slide up the catch on the external interface hatch to open.

☞ "9.6 Connecting via USB Cable"

2. Insert the USB flash drive into the USB port 1.



- When using a USB flash drive with 4 metal terminals on the surface, insert it with the terminal facing forwards to avoid damaging the USB port.

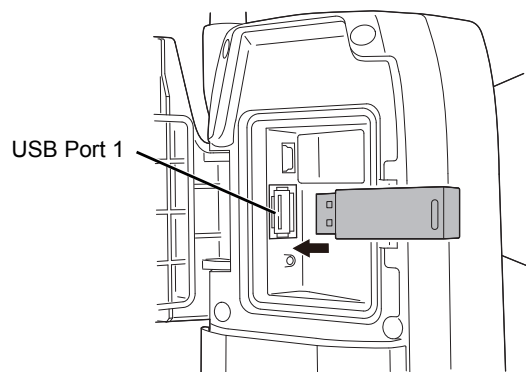

3. Close the external interface hatch until a click is heard.

4. Save data in the USB flash drive or import data from the memory.

☞ Program Explanations of each program

# 10.TARGET SIGHTING AND MEASUREMENT

A target can be automatically sighted using the Auto Pointing function or manually sighted by the operator using the sighting collimator and telescope.

When Auto Pointing is performed, the image sensor on the instrument detects the light beam reflected from the target (prism or reflective sheet target), the offset between the target and telescope reticle is calculated by image processing, then the angle measurement value obtained from the encoder is compensated. There is a possibility that the target and telescope reticle are not aligned.

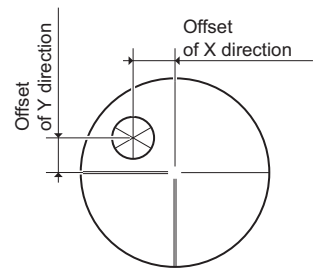

## Caution

- The instrument emits a laser beam during Auto Pointing and Auto Tracking operation.



- Auto Pointing can only be performed when a prism or sheet is used as the target. For reflectorless measurement, the target must be sighted manually.
- Detach the handle if the prism is located at the zenith.
  - ☞ "4.1 Parts of the Instrument Handle Detaching/attaching the RC Handle (Auto Tracking model)", "4.1 Parts of the Instrument Handle Detaching/attaching the Standard Handle (Auto Pointing model)"
- Auto Pointing may take long time if the prism is located at the zenith.
- When sighting a prism located at the zenith manually, use optional accessory diagonal eyepiece (DE30).
  - ☞ "10.3 Manually Sighting the Target"
- If more than one prism is located in the field of sight during Auto Pointing, the prism closer to the reticle is sighted. An operation error may occur and the instrument may not be able to find the prism depending on the prism installation status or measuring conditions.
- A prism beyond glass cannot be searched because a measurement error occurs.
- If an obstacle blocks the laser beam path between the instrument and the prism, instrument cannot find the target correctly.
- If strong light shines directly into the objective lens, measurement cannot be performed correctly.
- Use designated reflective prisms/reflective sheets for higher precision measurement. Make sure reflector type and aperture/sheet size are set correctly.
  - ☞ "19.3 Observation Conditions - Reflector (Target)", "24. TARGET SYSTEM"
- The following table suggests what size target to use for different distances when performing Auto Pointing with a reflective sheet target.

Distance	Target size
5 to 15 m	RS10 (10 mm)
5 to 30 m	RS30 (30 mm)
5 to 50 m	RS50 (50 mm)
10 to 50 m	RS90 (90 mm)

- It is recommended to use an appropriate prism for Auto Pointing and Auto Tracking measurement.
  - ☞  "Appropriate prism for Auto Pointing and Auto Tracking"

**Appropriate prism for Auto Pointing and Auto Tracking**  
 <Single prism>

The prism center is sighted optically during Auto Pointing and Auto Tracking operation. Therefore angle error will be caused depending on the prism constant values of the prism to use when it is not positioned in alignment with the objective lens of the instrument. The following recommended prisms with the described prism constant correction values are optically designed to eliminate the angle error. Those prisms with the described prism constant correction values enable accurate measurements without taking care to face the prism toward the instrument.

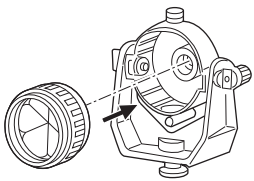
Prism	Prism constant correction value	Note
	-40	Directly attach AP01 whose constant correction value is "-40" to the tilt mount as indicated left. (Illustration is the Single tilt mount AP11)

When using prisms other than shown above, make sure to face the prism toward the instrument to keep the angle error as small as possible. (How the measurement error is caused is illustrated below).

How the measurement error is caused

When setting prism constant correction value to 0mm

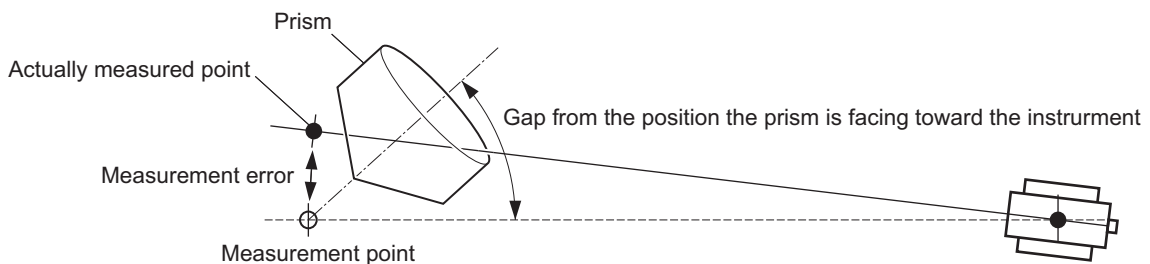

When setting prism constant correction value to an appropriate value

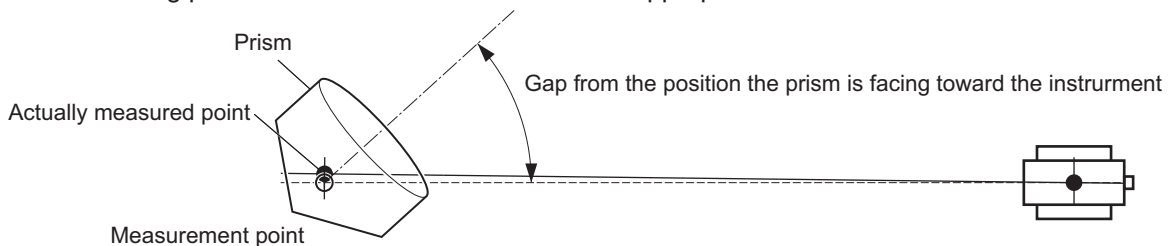

 Targets available for the iX: "24. TARGET SYSTEM"

<360° prism>

360° prisms reduce the possibility of "lost prism" during Auto Tracking measurement regardless of the direction of the prism.

Prism	Prism constant correction value
ATP1/ATP1S	-7

 Details of 360° prisms:"24. TARGET SYSTEM"

 Performing high accuracy measurement using 360° prism:"27.1 High Accuracy with the 360° Prism"



## 10.1 Auto Pointing and Auto Tracking Settings

Perform the settings for Auto Pointing and Auto Tracking measurement.

Setting items differ depending on models, Auto Pointing model or Auto Tracking model.

### PROCEDURE

1. Select "Obs.condition" in Config mode.

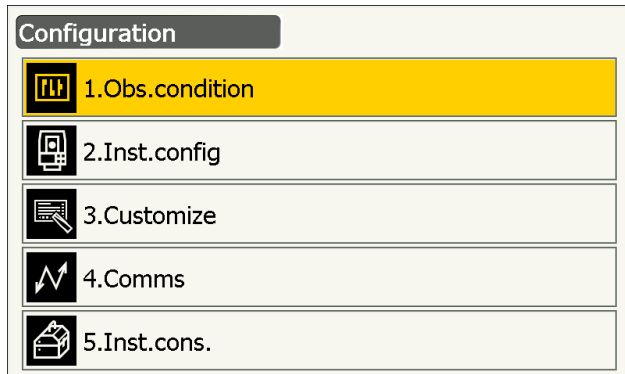

2. Select "Search/Track".

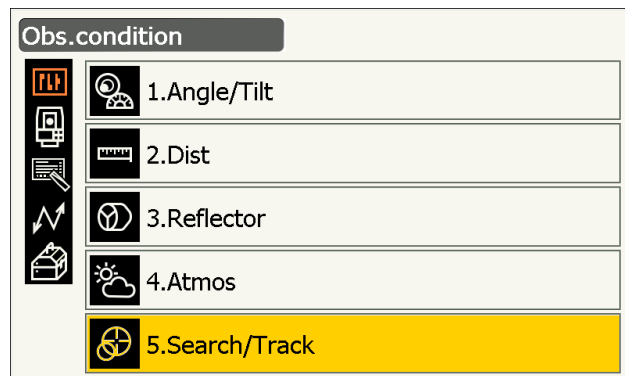

3. Set "(2) Track Setting" to "Search" when performing Auto Pointing only. Set "(2) Track Setting" to "Track" when performing Auto Tracking.  
Set "(7) Tracking Meas." to "(9) Wait time" only when performing Auto Tracking.

#### Items set and options (\*: Factory setting)

- (1) AUTO AIM
  - Fine/Rapid\*
- (2) Track Setting
  - None/Search\* (Auto Pointing model)
  - None/Search/Track\* (Auto Tracking model)
- (3) Srch method
  - G.S.\*/R.C.
- (4) Search pattern
  - 1\*/2/3
- (5) Vertical
  - 0 to 90° (15\*) (in 1°step, fractional part is rounded off)



(6) Horizontal (in 1°step, fractional part is rounded off)

0 to 180° (15\*)

(7) Tracking Meas. 

Standard\*/Fixed Averaging

(8) Forecast time

0.5 sec./1 sec./2 sec.\* /3 sec./4 sec./5 sec./

Auto



(9) Wait time

0 to 3600 sec. (5 sec.\*)

(10) TURN 

3"/5"\*/10"/20"/30"/60"

- "(3) Srch method " is fixed to "G.S." on Auto Pointing model.
- When setting "(9) Wait time", **[HOLD]** is displayed. Press **[HOLD]** to set "Wait time" to no limits.

 "10.2 Auto Pointing and Auto Tracking Function for Target Sighting/Measurement  Lost Prism"

### AUTO AIM

When the target enters the field-of-view within the set limit for Auto Pointing completion (the limit differs between "Fine" and "Rapid"), the instrument starts acquiring data (the amount of data differs between "Fine" and "Rapid") then completes the Auto Pointing by calculating the data.

Set to "Fine" for greater accuracy during Auto Pointing. Make sure that the prism is securely mounted on a tripod etc.

Set to "Rapid" when supporting the pole by hand.

When "Fine" is set the instrument checks that the prism position is stable, then searches for the prism direction. Once the instrument confirms that the prism is sighted at the approximate center of the field-of-view, Auto Pointing is complete. Although this setting provides greater accuracy, when supporting the pole by hand, hand movements will result in Auto Pointing taking too long to complete and a "Time out" error will occur.

When "Rapid" is set however, Auto Pointing can be performed even with slight instability of prism position or minor shifts of target position in the field-of-view. The instrument will use the data obtained to determine the direction of the target.

Auto Pointing performed using the "Rapid" setting can be completed in a much quicker time than the "Fine" setting.

"Fine" is recommended when a high level of measurement accuracy is needed. The range for the offset between the target and reticle after Auto Pointing completed changes as shown below depending on the Srch. accuracy setting.

### Srch method

Selects search before distance measurement option.

When set to "G.S." the instrument will search for the target in the area specified in the Search area display. When set to "R.C.", the instrument will wait for a Turning command to be issued from the Remote Controller before starting Auto Pointing. Such commands can be received only when Beam detector for Remote Controller is mounted on the handle of the instrument.

### Search pattern

The search pattern is the rotating method of telescope and instrument to find the target prism in search mode.

In Pattern "1" instrument starts searching the prism at the point where the prism is lost and gradually expands the searching area in vertical direction, keeping the horizontal angular width.

Pattern "2" can be selected to search for the prism. The search pattern tries to locate the prism in a very short time.

In pattern "3", instrument starts searching the prism at the point where the prism is lost and gradually expands the searching area in horizontal and vertical direction. In every pattern, the searching is arranged to 2 times until the reflector is found. The auto tracking mode changes to manual mode when the reflector could not found out within 2 times searching, and returns to the point where the reflector is lost.

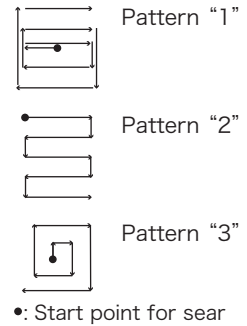

### TURN

This option allows the user to set a tolerance range for setting accuracy (after rotation to a specified angle). For example, when this option is set to 30" and [INV], [H.TURN], or [TURN] is pressed, the instrument will stop rotation within 30" of the specified rotation angle.

### Tracking Meas.

This setting refers to angle display when performing Auto Tracking.

When set to "Standard", the angle value is corrected by the image sensor all the time during Auto Tracking. "Standard" is effective when measuring a moving object.

In the "Fixed Averaging" setting, the angle value corrected by the image sensor is averaged and then fixed when the iX automatically detects the rest state of target during Auto Tracking. The angle value will be fixed until the target starts moving again. Therefore, the angle display during the target is in resting state will be stabilized and scintillation effect will be reduced as well. "Fixed Averaging" is effective when measuring a target in resting state during Auto Tracking.

### Search operation during Auto Pointing

When the target enters the field-of-view within the set limit (setting of "Auto AIM" and "Measure Acc.") for Auto Pointing completion, the instrument stops moving, calculates the offset between the target and telescope reticle by image processing, then compensates the angle measurement value obtained from the encoder. This compensation enables accurate sighting in a short time. Even though the target and telescope reticle may appear to be misaligned, actual angle value of center of the target is displayed. Compensated values are displayed in blue.

If the instrument is rotated (manually or using the Jogs) more than 10", compensation will be canceled, the angle reverts to that obtained from the encoder, and the angle values are once again displayed in black. Compensation is automatically performed when performing Auto Tracking. Terminating Auto Tracking or powering OFF the instrument will cancel the compensation function.

4. Press {Enter} to complete setting.

## 10.2 Auto Pointing and Auto Tracking Function for Target Sighting/Measurement

The procedures for sighting to measuring distance differ depending on models, Auto Pointing model or Auto Tracking model.

With the Auto Tracking function, the instrument searches for and sights the target. The instrument will then follow that target as it is moved from measurement point to measurement point. The Remote Control System is recommended for high performance Auto Tracking measurement.

### PROCEDURE Measurement using Auto Pointing function only

---

1. Use the sighting collimator to aim the objective lens in the general direction of the target. The vertical and horizontal Jogs can be used for precise adjustments of the instrument and telescope.
2. Press **[SRCH]** in any Observation mode screen. The telescope and top half of the instrument rotate and target auto-search begins. When the target is found, the instrument sights the prism and stops.
  - ☞ Allocating the **[SRCH]** Operating icon:  
"19.12 Allocating Operating Icons"

### PROCEDURE Measurement using Auto Pointing and Auto Tracking function (Auto Tracking model only)

---

1. Use the sighting collimator to aim the objective lens in the general direction of the target. (The vertical and horizontal Jogs can be used for precise adjustments of the instrument and telescope.)
2. Select **[MEAS]**, **[RC Cont]**, or **[SRCH]** in any Observation mode screen. The telescope and top half of the instrument rotate and target auto-search begins. When the target is found, the target is aligned in the field-of-view and Auto Tracking starts.
3. Press **[TRK Off]** in a Observation mode screen to stop Auto Tracking.
  - When **[STOP]** is pressed, distance measurement will stop but Auto Tracking will remain active.

**Lost Prism**

In the event that an obstacle prevents the instrument sighting the target during Auto Tracking, the instrument will predict the direction in which the target will travel and continue Auto Tracking based on this prediction for the time period set in "Forecast time". If the instrument re-acquires the target in this predicted direction, Auto Tracking continues without change. If the target is not re-acquired however, the target is considered "lost" ("Target lost" status) and the instrument starts "Prism wait" and "Search (twice)" in order. If the instrument re-acquires the target in this process, Auto Tracking continues.

"Prism wait" will continue for the time period set in "Wait time".

If the target is not re-acquired after "Search (twice)", sighting terminates. Start Auto Tracking procedure again from step 1.

"Wait time" being set to "HOLD" (no limits), Auto Tracking procedure is as follows. The telescope does not move and keeps "Prism wait" status and when the prism comes into the field of view, the instrument starts Auto Tracking.

"Forecast time" (duration of search in predicted direction) and "Wait time" settings: "10.1 Auto Pointing and Auto Tracking Settings" step 4

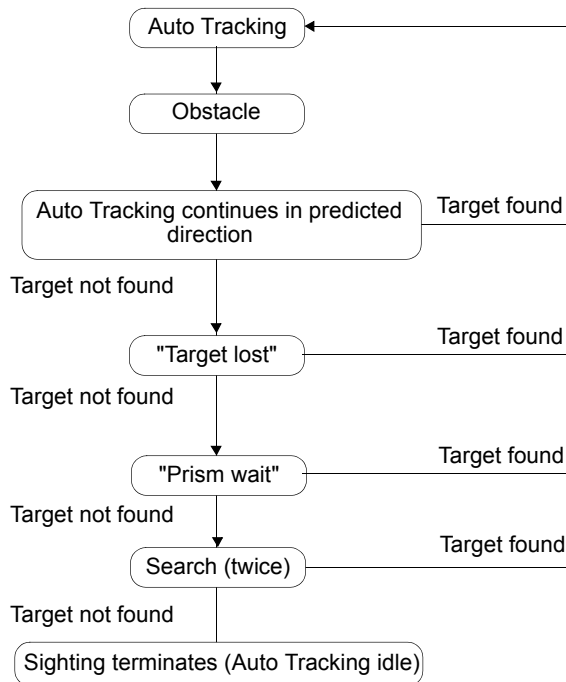

**Difference in search and measuring distance operation**

Operating icons related to sighting and measuring distance are different between Auto Pointing models and Auto Tracking models.

Search and measuring distance operations initiated by related Operating icons are different depending on the setting of "Track setting" and "Search method" in <Search/Track>.

- Auto Pointing model (there is no Operating icons related to Auto Tracking). |

"Search/Track" setting Operating icon	When "Search" set in "Track Setting"	When "None" set in "Track Setting"
	"Srch method" is fixed to "G.S."	
[SRCH]	Performs Auto Pointing	
[MEAS]	Performs Auto Pointing then angle/distance measurement	Performs angle and distance measurement

- Auto Tracking model

"Search/Track" setting Operating icon	When "Search" set in "Track Setting"	When "Track" set in "Track Setting"		When "None" set in "Track Setting"
	"Srch method" is fixed to "G.S."	When "R.C. " set in "Srch method"	When "G.S." set in "Srch method"	
[SRCH]	Performs Auto Pointing	Performs Auto Pointing then Auto Tracking		Performs Auto Pointing
[MEAS]	Performs Auto Pointing then angle/distance measurement	Performs Turning operation then distance measurement/Auto Tracking	Performs Auto Pointing then distance measurement/Auto Tracking	Performs angle and distance measurement
[RC]		Rotates directly in the direction of the Remote Controller then performs Auto Pointing/Auto Tracking		Rotates in the direction specified by the Remote Controller then performs Auto Pointing
[<-RC]		Rotates in a counterclockwise direction (from the point of view of the Remote Controller) then performs Auto Pointing/Auto Tracking		Rotates in a counterclockwise direction (from the point of view of the Remote Controller) then performs Auto Pointing
[RC->]		Rotates in a clockwise direction (from the point of view of the Remote Controller) then performs Auto Pointing/Auto Tracking		Rotates in a clockwise direction (from the point of view of the Remote Controller) then performs Auto Pointing
[RC Cont]		Nullifies the current measurement position then continues Turning operation/Auto Tracking		Nullifies the current measurement position then continues Turning operation
[TRK On] (Auto Tracking model only)		Performs Turning operation then Auto Tracking	Performs Auto Pointing then Auto Tracking	Performs Auto Tracking *

\*: Pressing [TRK On] when "Track Setting" is set to "None" will result in one of the following operations being performed.

When "R.C." selected: Performs Turning operation then Auto Tracking

When "G.S." selected: Performs Auto Pointing then Auto Tracking

### Turning operation

The instrument locates the Remote Controller by detecting the laser beam output by the Remote Controller, then starts Auto Pointing.

When Turning operation cannot be performed correctly, check if the handle is attached securely. Also, clean the beam detector for Remote Controller and contacts of the handle.

 "4.2 Mode Structure Detaching/attaching the RC Handle (Auto Tracking model)"

### 10.3 Manually Sighting the Target

The procedures of sighting the target manually without using Auto Pointing function are explained in this section.



- When sighting the target, strong light shining directly into the objective lens may cause the instrument to malfunction. Protect the objective lens from direct light by attaching the lens hood. Observe to the same point of the reticle when the telescope face is changed.

#### PROCEDURE

##### 1. Focus on the reticle

Look through the telescope eyepiece at a bright and featureless background.

Turn the eyepiece screw clockwise, then counterclockwise little by little until just before the reticle image becomes focussed.

Using these procedures, frequent reticle refocussing is not necessary since your eye is focussed at infinity.

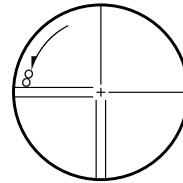

##### 2. Sight the target

Use the Sighting collimator to bring the target into the field of view. Turn the vertical and horizontal Jogs for fine sighting adjusting.

##### 3. Focus on the target

Turn the telescope focussing ring to focus on the target.

Turn the vertical and horizontal fine motion screws to align the target with the reticle.

The last adjustment of each fine motion screw should be in the clockwise direction.

##### 4. Readjust the focus until there is no parallax

Readjust the focus with the focussing ring until there is no parallax between the target image and the reticle.



#### Eliminating parallax

This is the relative displacement of the target image with respect to the reticle when the observer's head is moved slightly before the eyepiece.

Parallax will introduce reading errors and must be removed before observations are taken. Parallax can be removed by refocussing the reticle.



#### Sighting manually

When sighting manually, set "Track Setting" to "None" in <Search/Track>, then use the Sighting collimator to bring the target into the field of view. When the target is in the field-of-view, use the Jogs to make fine adjustments and accurately sight the center of the prism.

It is recommended that a slow Jog turning speed is used for greater stability when performing fine adjustments.

# 11. ANGLE MEASUREMENT

This section explains the procedures for basic angle measurement in Observation mode.

- It is possible to allocate Operating icons in measurement menus to suit various applications and the ways that different operators handle the instrument.  
☞ "19.12 Allocating Operating Icons"

## 11.1 Measuring the Horizontal Angle between Two Points (Horizontal Angle 0°)

Use the "OSET" function to measure the included angle between two points. The horizontal angle can be set to 0 at any direction.

### PROCEDURE

1. Sight the first target as at right.  
☞ "10. TARGET SIGHTING AND MEASUREMENT"

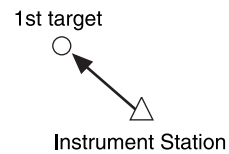

2. Press **[OSET]**.  
**[OSET]** will flash, so press **[OSET]** again.  
The horizontal angle at the first target becomes 0°.



3. Sight the second target.

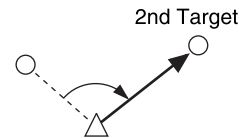

The displayed horizontal angle (HA-R) is the included angle between two points.





## 11.2 Setting the Horizontal Angle to a Required Value (Horizontal Angle Hold)

You can reset the horizontal angle to a required value and use this value to find the horizontal angle of a new target.

### PROCEDURE

1. Sight the first target.
2. Switch the Operating icons and press **[H-SET]**.  
<Set H angle> is displayed.
3. Enter the angle you wish to set, then press **[OK]**.  
The value that is input as the horizontal angle is displayed.

- The same setting can also be performed with coordinate and azimuth input.

 "13.2 Azimuth Angle Setting"

4. Press **[OK]** to confirm the input value and display the new horizontal angle.

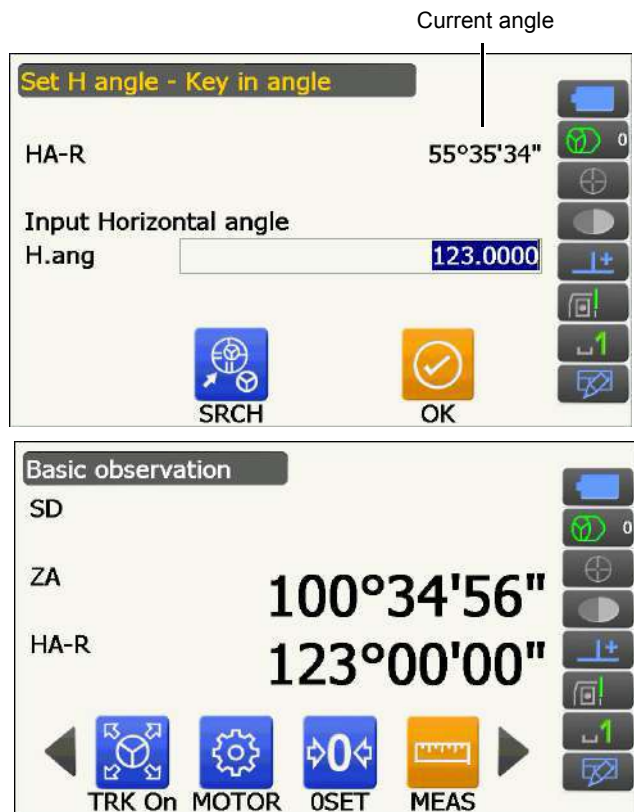

5. Sight the second target.  
The horizontal angle from the second target to the value set as the horizontal angle is displayed.

#### Note

- Pressing **[HOLD]** performs the same function as above. Press **[HOLD]** to set the displayed horizontal angle. Then, set the angle that is in hold status to the direction you require.  
 Allocating **[HOLD]**: "19.12 Allocating Operating Icons"

### 11.3 Turning the Instrument from the Reference Angle to a Specified Angle

The instrument automatically turns from the reference direction to the specified angle (target).

- instrument also turns to the target coordinates when reference angle is omitted.



- Rotation may not be completed correctly when specifying an angle near the zenith or nadir if "Tilt crn" or "Coll. crn" is set to "Yes" in <Angle/Tilt>.

☞ "19.1 Observation Conditions - Angle/Tilt"

#### PROCEDURE

1. Sight the point you will use as the reference angle and set it as the reference angle.  
Sight the reference point and press **[OSET]**, or input the reference point angle.  
☞ "11.1 Measuring the Horizontal Angle between Two Points (Horizontal Angle 0°)"/  
"11.2 Setting the Horizontal Angle to a Required Value (Horizontal Angle Hold)"
2. Press **[MOTOR]**.



Enter the vertical and horizontal angles in the Motor display.

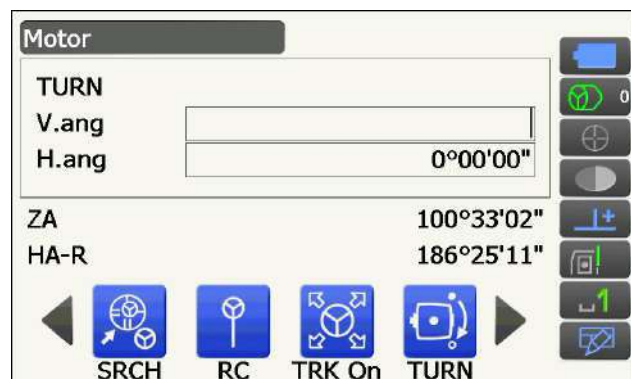

3. After confirming the angle, press **[TURN]**. The instrument moves to the point (target) entered in step 2.

- The following operation can be select by switching the Operating icons.

**[COORD]** : set the angle by coordinates

**[INV]** : rotate the top of the instrument and telescope 180°

**[CNFG]** : set motor settings

☞ "10.1 Auto Pointing and Auto Tracking Settings"

- The following Operating icons are also available on the Auto Tracking model combined with the remote controller.

**[RC]** : Rotates directly in the direction of the Remote Controller

**[<-RC]** : Rotates in a counterclockwise direction (from the point of view of the Remote Controller)

**[RC->]** : Rotates in a clockwise direction (from the point of view of the Remote Controller)

**[RC Cont]**: Nullifies the current measurement position then continues Turning operation/

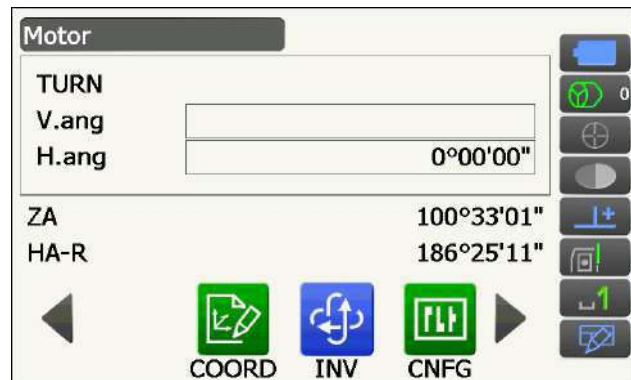

## 11.4 Angle measurement and Outputting the Data

The following explains angle measurement and the features used to output measurement results to a computer or other external devices.

☞ Setting procedures: "9. CONNECTING TO EXTERNAL DEVICES"

☞ Cables: "25. ACCESSORIES"

☞ Output format and command operations: "Communication manual"

### PROCEDURE

- Connect instrument and external device.
  - ☞ Setting procedures: "9. CONNECTING TO EXTERNAL DEVICES"
- Allocate the **[HVOUT-T]** or **[HVOUT-S]** Operating icon to the Observation mode screen.
  - ☞ "19.12 Allocating Operating Icons"

#### Note

- Pressing the Operating icon outputs data in the following format.

**[HVOUT-T]** :GTS format

**[HVOUT-S]** : SET format

- Sight the target point.
- Press **[HVOUT-T]** or **[HVOUT-S]**.  
Output measurement data to peripheral equipment.

# 12.DISTANCE MEASUREMENT

Perform the following settings as preparation for distance measurement in Observation mode.

- Distance measurement mode
  - ☞ "19.2 Observation Conditions - Dist"
- Target type (including prism constant correction value and aperture information)
  - ☞ "19.3 Observation Conditions - Reflector (Target)"
- ppm
  - ☞ "19.4 Observation Conditions - Atmosphere"
- Auto Pointing/Auto Tracking relating items
  - ☞ "10.1 Auto Pointing and Auto Tracking Settings"
- It is possible to allocate Operating icons in measurement menus to suit various applications and the ways that different operators handle the instrument.
  - ☞ "19.12 Allocating Operating Icons"

## Caution

- When using the laser-pointer function, be sure to turn OFF the output laser after distance measurement is completed. Even if distance measurement is canceled, the laser-pointer function is still operating and the laser beam continues to be emitted.



- Make sure that the target setting on the instrument matches the type of target used. The instrument automatically adjusts the intensity of the laser beam and switches the distance measurement display range to match the type of target used. If the target does not correspond to the target settings, accurate measurement results cannot be obtained.
- Accurate measurement results cannot be obtained if the objective lens is dirty. Dust it off with the lens brush first, to remove minute particles. Then, after providing a little condensation by breathing on the lens, wipe it off with the silicon cloth.
- During reflectorless measurement, if an object obstructs the light beam used for measurement or an object with a high reflective factor (metal or white surface) is positioned behind the target, accurate measurement results may not be received.
- Scintillation may affect the accuracy of distance measurement results. Should this occur, repeat measurement several times and use the averaged value of the obtained results.

## 12.1 Returned Signal Checking

Check to make sure that sufficient reflected light is returned by the target sighted by the telescope. Checking the returned signal is particularly useful when performing long distance measurements.

## Caution

- The laser beam is emitted during returned signal checking.



- When the light intensity is sufficient even though the center of the reflective prism and the reticle are slightly misaligned (short distance etc.), "●" will be displayed in some cases, but in fact, accurate measurement is impossible. Therefore make sure that the target center is sighted correctly.

## PROCEDURE

---

1. Accurately sight the target.

2. Press **[S-LEV]** in Observation mode.  
 <Aiming> is displayed.  
 [ESC] Allocating **[S-LEV]**: "19.12 Allocating  
 Operating Icons"

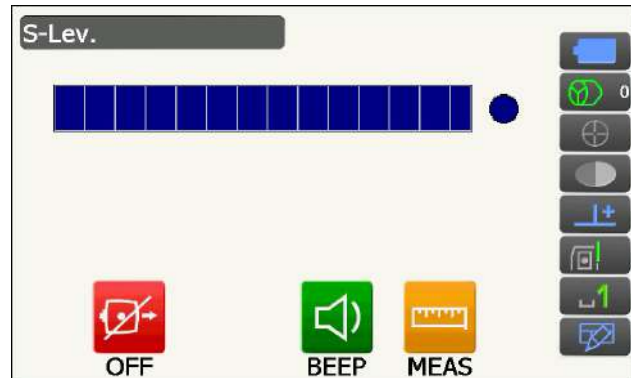

When **[S-LEV]** is pressed, a gauge indicating light intensity is displayed.

- The more [████████] displayed, the greater the quantity of reflected light.
- If "●" is displayed, only enough light for the measurement is returned.
- When "●" is not displayed, accurately resight the target.

**[BEEP]/[OFF]**

: Sets a buzzer sound when measurement is possible. Press to switch on and off.

**[MEAS]** : Returns to Observation mode and starts angle and distance measurement regardless of "Track Setting" setting.

3. Press **[OFF]** to finish signal checking.  
 Press **{ESC}** to return to the previous screen.

Note

- When [████████] is displayed persistently, but "●" is not, contact your local dealer.
- If no key operations are performed for two minutes, the display automatically returns to the previous screen.

## 12.2 Using the Guide Light in Distance Measurement

The color and flashing speed of the guide light indicates the status of the instrument and can be known when the user is located at a distance from the instrument.

 Switching the guide light ON/OFF "5.1 Basic Key Operation"

- The pattern of the guide light can be changed.

 "19.7 Instrument Conditions - Instrument"



- Even if the guide light is set to ON, the guide light is OFF during distance measurement with the target type "N-Prism" or returned signal checking.

### ● Guide light status and meaning

Status of the instrument

Light status	Meaning
Slow flashing (Red and green simultaneously)	Waiting
	Search error (error screen only)
Fast flashing (Red and green simultaneously)	Searching in progress
	Measuring (continuous measurement)
	Returned signal checking in progress
	Auto Tracking in progress (Auto Tracking model only)
	Auto Tracking in predicted direction (Auto Tracking model only)
Green and red alternate flashing	Distance measurement error (no signal, sighting error)
	"Prism wait"

## 12.3 Distance and Angle Measurement

An angle can be measured at the same time as distance.

- The search range can be set.

 "10.1 Auto Pointing and Auto Tracking Settings"

### Caution

- The laser beam is emitted during Auto Pointing and Auto Tracking.

### PROCEDURE

1. Face the instrument in the direction of the target  
Use the sighting collimator to aim the instrument and telescope toward the target.

 "10. TARGET SIGHTING AND MEASUREMENT"

2. Start measurement.  
Press **[MEAS]**.



Measurement starts and the measured distance data (SD), vertical angle (ZA), and horizontal angle (HA-R) are displayed.



3. Press **[STOP]** to quit distance measurement.



**Note**

- If the single measurement mode is selected, measurement automatically stops after a single measurement.
- During fine average measurement, the distance data is displayed as SD1, SD2,... to SD9. When the designated number of measurements has been completed, the average value of the distance is displayed in the "SDA" line.
- The distance and angle that are most recently measured remain stored in the memory until the power is off and can be displayed at any time by pressing **[CALL]**.  
 Allocating **[CALL]**: "19.12 Allocating Operating Icons"

## 12.4 Distance Measurement and Outputting the Data

The following explains distance measurement and the features used to output measurement data to a computer or external devices.

- ☞ Setting procedures: "9. CONNECTING TO EXTERNAL DEVICES"
- ☞ Cables: "25. ACCESSORIES"
- ☞ Output format and command operations: "Communication manual"

### PROCEDURE

---

1. Connect instrument and external device.
  - ☞ Setting procedures: "9. CONNECTING TO EXTERNAL DEVICES"
2. Sight the target point.
3. Press **[HVDOUT-T]** or **[HVDOUT-S]** to measure the distance and output the data to the external device.
4. Press **[STOP]** to stop outputting data and return to Observation Mode.



## 12.5 REM Measurement

An REM measurement is a function used to measure the height to a point where a target cannot be directly installed such as power lines, overhead cables and bridges, etc.

The height of the target is calculated using the following formula.

$$H_t = h_1 + h_2$$

$$h_2 = S \sin \theta_{z1} \times \cot \theta_{z2} - S \cos \theta_{z1}$$

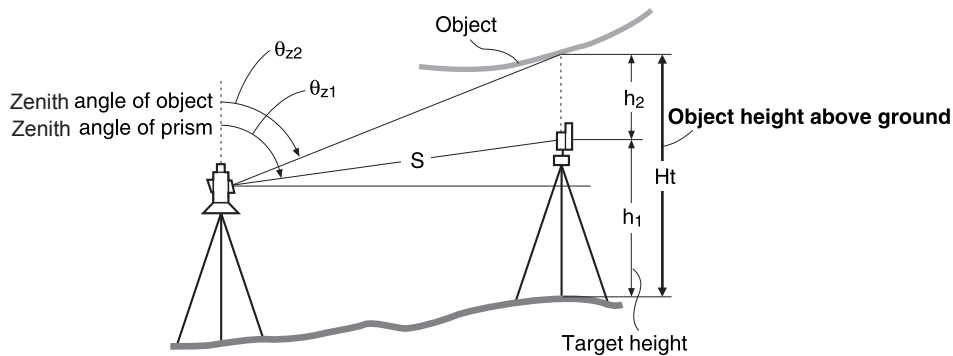

- It is possible to allocate Operating icons in measurement menus to suit various applications and the ways that different operators handle the instrument.

"19.12 Allocating Operating Icons"

### PROCEDURE

- Set the target directly under or directly over the object and measure the target height with a tape measure etc.

Press **[HT]** and enter the target height.

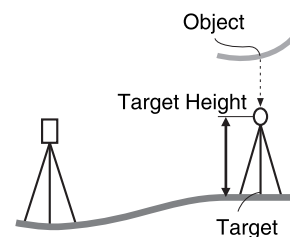

- Select "REM" in <Menu>.

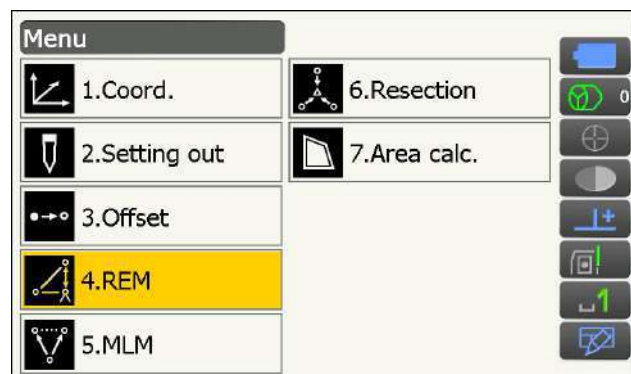

- Sight the target and press **[MEAS]** to start measurement. Press **[STOP]** to stop the measurement.



The measured distance data, vertical angle and horizontal angle are displayed.



4. Sight the object, then press **[REM]** to start REM measurement is started. The height from the ground to the object is displayed in "Ht.". Press **[STOP]** to stop the measurement.

- To re-observe the target, sight the target then press **[MEAS]**.
- To continue REM measurement, press **[REM]**.



**Note**

- When measurement data already exists, select "REM" in <Menu> as in step 2 to proceed to step 4 and start REM measurement. Press **[STOP]** to stop the measurement.

# 13.COORDINATE MEASUREMENT

By performing coordinate measurements it is possible to find the 3-dimensional coordinates of the target based on station point coordinates, instrument height, target height, and azimuth angles of the backsight station which are entered in advance.

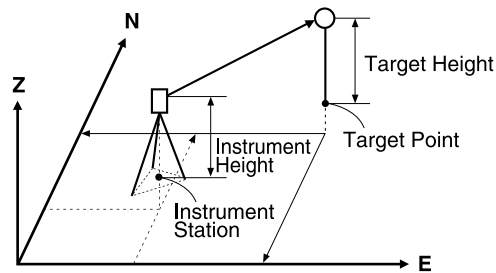

- It is possible to allocate Operating icons in measurement menus to suit various applications and the ways that different operators handle the instrument.  
☞ "19.12 Allocating Operating Icons"

## 13.1 Entering Instrument Station Data

Before performing coordinate measurement, enter instrument station coordinates and instrument height.



- "Occupy" on the software represents instrument station.

### PROCEDURE

1. First measure the instrument height with a tape measure, etc.
2. Select "Coord." in <Menu>.

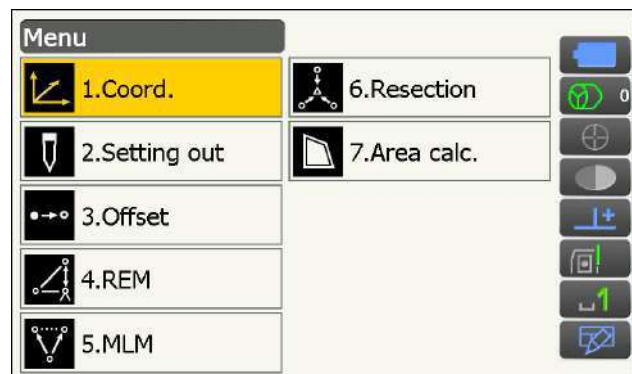

3. Select "Occupy setup".

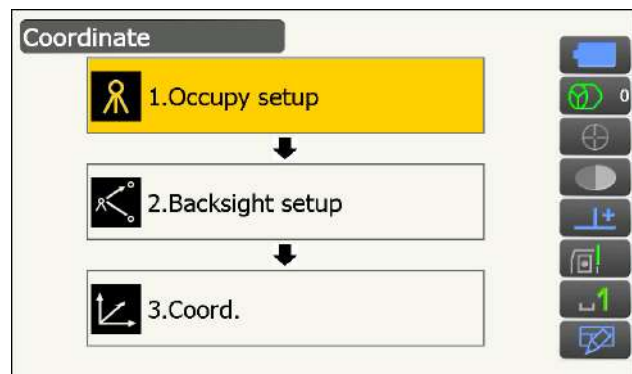

Enter instrument station coordinates, instrument height (HI) and target height (HR).

Occupy setup	
Occ.North	100.000
Occ.East	150.000
Occ.Elev	200.000
HI	1.500 m
HR	1.500 m

**OK**

- Press **[OK]** to set the input values. <Bacsight setup> is displayed again.

### 13.2 Azimuth Angle Setting

Based on the instrument station coordinates and backsight station coordinates which have already been set, the azimuth angle of the backsight station is calculated.

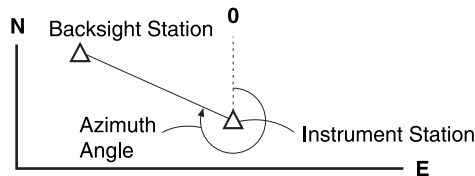

#### PROCEDURE Entering coordinates

- Select "Bacsight setup" in <Coordinate>.
  - <Bacsight setup> can also be displayed from the screen in step 4 of "13.1 Entering Instrument Station Data".
- Tap the screen title to display popup and select "Key in coord" display. Enter the backsight station coordinates.

Coordinate	
1.Occupy setup	↓
<b>2.Bacsight setup</b>	↓
3.Coord.	

- **[SRCH]**: Performs Auto Pointing. Rotates the instrument in the direction of the backsight.
  - **[Azimuth] / [H.ANG] / [None] / [0 SET]**: Switches horizontal angle setting method.
-  "Horizontal angle settings"

Bacsight setup - Key in coord	
BS North	10.000
BS East	10.000
BS Elev.	0.000
Azimuth	237°15'53"
H.ang	237°15'53"
SD	1.212m
ZA	48°52'07"
HA-R	212°08'16"





- When checking backsight distance, sight the backsight station and press **[MEAS]**. Press **[STOP]** to display the distance calculated from coordinates, the measured distance, and the difference between the two. Press **[YES]** to set the azimuth angle and display <Coord. measurement>.

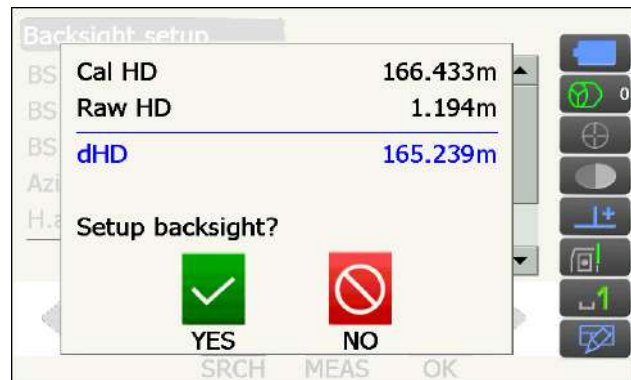

3. Press **[OK]** to set the azimuth angle. <Coord. measurement> is displayed.

### PROCEDURE Entering angle

1. Select "Backsight setup" in <Coordinate>. <Backsight setup> is displayed.

- <Backsight setup> can also be displayed from the screen in step 4 of "13.1 Entering Instrument Station Data".

2. Tap the screen title to display popup and select "Key in angle" display. Enter the desired angle in "H.ang".

- **[SRCH]**: Performs Auto Pointing. Rotates the instrument in the direction of the backsight.



3. Press **[OK]** to set the input values. <Coord. measurement> is displayed.

### PROCEDURE Entering azimuth

1. Select "Backsight setup" in <Coordinate>. <Backsight setup> is displayed.

- <Backsight setup> can also be displayed from the screen in step 4 of "13.1 Entering Instrument Station Data".

2. Tap the screen title to display popup and select "Key in azimuth" display and enter the desired angle in "Azimuth".

- **[SRCH]**: Performs Auto Pointing. Rotates the instrument in the direction of the backsight.
  - **[Azimuth] / [H.ANG] / [None] / [0 SET]**: Switches horizontal angle setting method.
-  "Horizontal angle settings"



3. Press **[OK]** to set the input values. <Coord. measurement> is displayed.

 **Horizontal angle settings**

Azimuth (set both horizontal and azimuth angles to the same value)/H.ang (input both horizontal and azimuth angles)/None (input azimuth angle only)/0 SET (horizontal angle set to 0°)

**13.3 3-D Coordinate Measurement**

The coordinate values of the target can be found by measuring the target based on the settings of the instrument station and backsight station.

The coordinate values of the target are calculated using the following formulae.

$$N1 \text{ Coordinate} = N0 + S \times \sin Z \times \cos Az$$

$$E1 \text{ Coordinate} = E0 + S \times \sin Z \times \sin Az$$

$$Z1 \text{ Coordinate} = Z0 + S \times \cos Z + ih - th$$

N0: Station point N coordinate  
 S: Slope distance  
 ih: Instrument height  
 E0: Station point E coordinate  
 Z: Zenith angle  
 th: Target height  
 Z0: Station point Z coordinate  
 Az: Direction angle

"Null" coordinates will not be included in calculations. "Null" is not the same as zero.

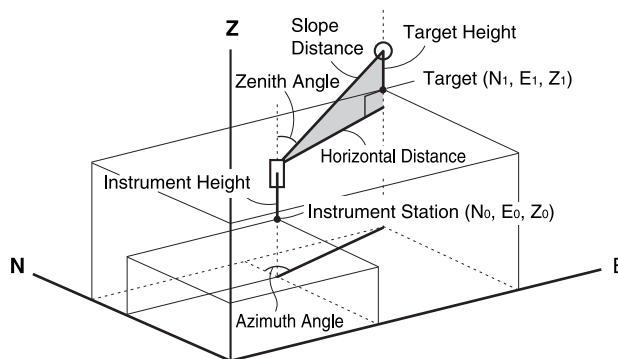

**PROCEDURE**

1. Sight the target at the target point.

2. Select "Coord." in <Coordinate>.

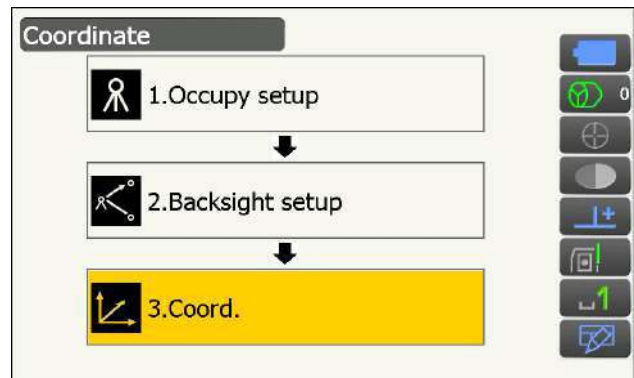

Press **[MEAS]** to start measurement. Press **[STOP]** to stop the measurement. The coordinates of the target point are displayed.

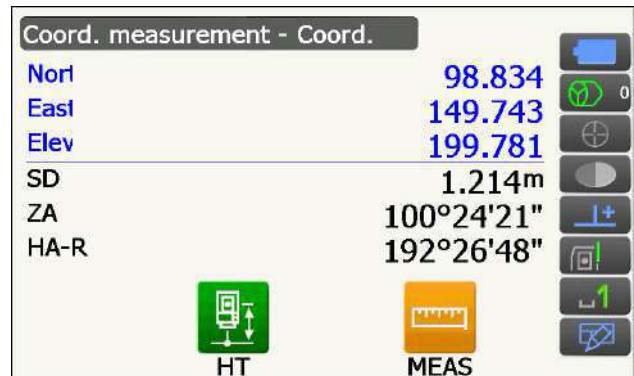

- Tap the screen title to display popup and select "Graphic" display. The coordinates are displayed on a graph.

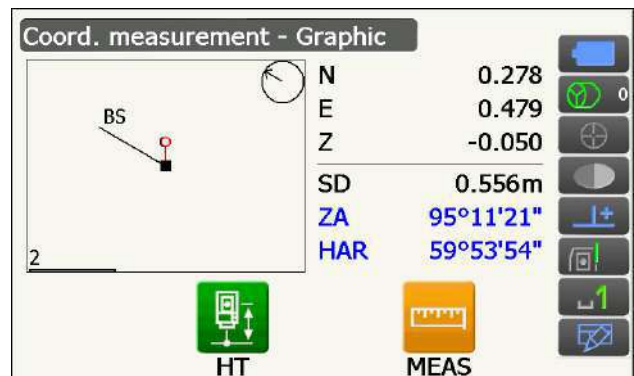

- Press **[HT]** to set the instrument station data again. When the target height of the next point is different, input it before the observation.

3. Sight the next target and press **[MEAS]** to begin measurement. Continue until all targets have been measured.
4. When coordinate measurement is completed, press **{ESC}** to return to <Coord. measurement>.

# 14. RESECTION MEASUREMENT

Resection is used to determine the coordinates of an instrument station by performing multiple measurements of points whose coordinate values are known. Registered coordinate data can be recalled and set as known point data. Residual of each point can be checked, if necessary.

Entry	Output
Coordinates of known point : $(N_i, E_i, Z_i)$	Station point coordinates : $(N_0, E_0, Z_0)$
Observed horizontal angle : $H_i$	
Observed vertical angle : $V_i$	
Observed distance : $D_i$	

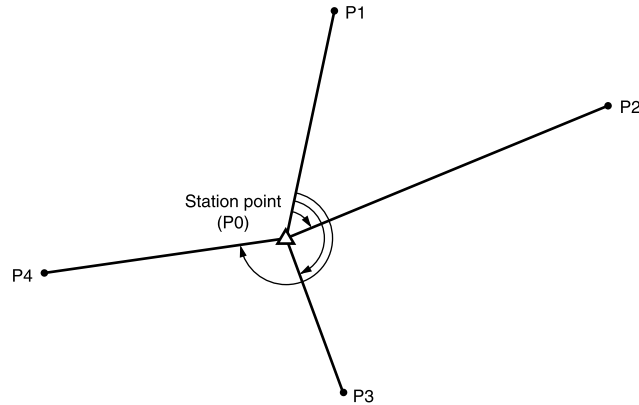

- Between 2 and 10 known points can be measured by distance measurement, and between 3 and 10 known points by angle measurement.
- The more known points there are and the more points there are whose distance can be measured, the higher the precision of the coordinate value calculation.
- It is possible to allocate Operating icons in measurement menus to suit various applications and the ways that different operators handle the instrument.

 "19.12 Allocating Operating Icons"



## 14.1 Coordinate Resection Measurement

N, E, Z of an instrument station is determined by the measurement.

### PROCEDURE

1. Select "Resection" in <Menu>.

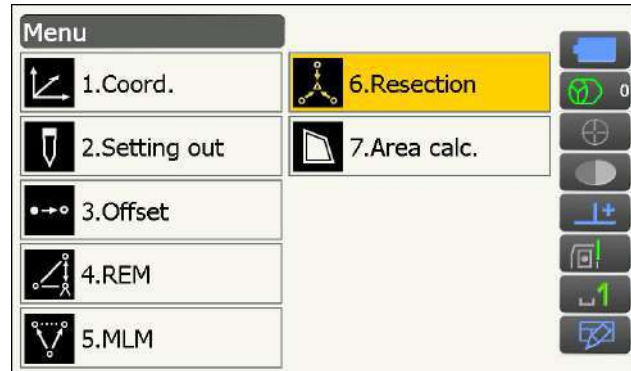

2. Select "NEZ" to display <Resection/Known pt.>.



3. Input the known point.

After setting the coordinates and target height for the first known point press **[NEXT]** to move to the second point.

- Press **[PREV]** to return to settings for the previous point.

When all required known points have been set, press **[OK]**.



4. Sight the first known point and press **[MEAS]** to begin measurement.

The measurement results are displayed on the screen.

- Press **[ANGLE]** to measure the angle only.



5. Press **[YES]** to use the measurement results of the first known point.

- You can also input target height here.
- Press **[NO]** to return to the screen in step 4 and perform measurement again.



6. Repeat procedures 4 to 5 in the same way from subsequent points.  
When the minimum quantity of observation data required for the calculation is present, **[CALC]** is displayed.



**[AUTO]** will be displayed for the 3rd point onwards. Pressing **[AUTO]** will rotate the instrument to the next point and start auto measurement.

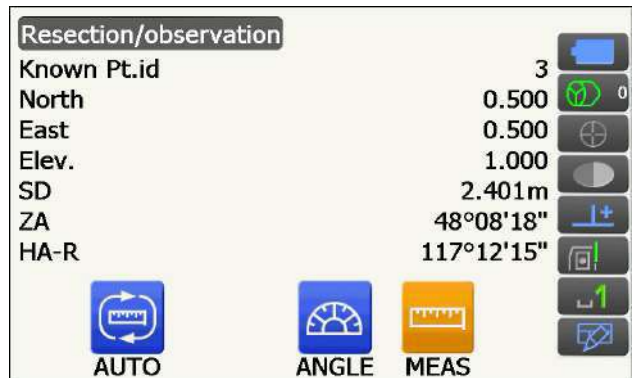

- Press **[STOP]** during auto measurement to display a confirmation message. Press **[YES]** in this message to return to the first point measured using auto measurement. Measurement can now be continued manually. Press **[NO]** to continue measurement manually from the current position.

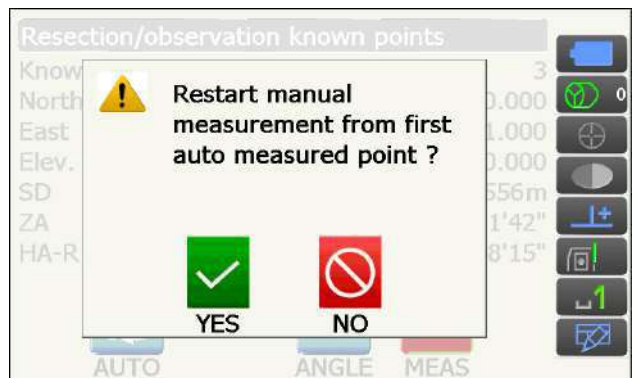

7. Press **[CALC]** or **[YES]** to automatically start calculations after observations of all known points are completed. Instrument station coordinates, station elevation, and standard deviation, which describes the measurement accuracy, are displayed.

- "Occ. Elev" is not displayed when the result is calculated only by angle measurements.
- In auto measurement, the result is automatically displayed when the measurement is completed.



Standard deviation for the northing, easting and elevation coordinates of each point are displayed by pressing **[DETAIL]**.



8. If there are problems with the results of a point, align the cursor with that point and press **[OMIT]**. "OMIT" is displayed to the right of the point. Repeat for all results that include problems.

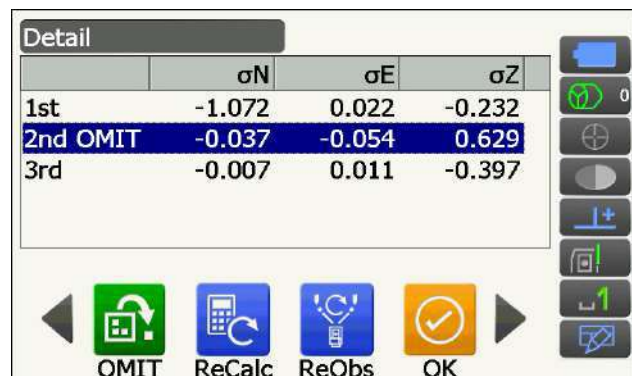

9. Press **[RE\_CALC]** to perform calculation again without the point designated in step 8. The result is displayed.

If there are no problems with the result, go to step 10.

If problems with the result occur again, perform the resection measurement from step 4.

- Press **[RE OBS]** to measure the point designated in step 8.

If no points are designated in step 8, all the points or only the final point can be observed again.



- Switch the Operating icons and press **[ADD]** when there is a known point that has not been observed or when a new known point is added.

Detail			
	$\sigma_N$	$\sigma_E$	$\sigma_Z$
1st	-0.887	0.076	-0.232
2nd OMIT	-0.010	-0.019	0.629
3rd	0.074	-0.117	-0.397

**ADD**

10. Press **[OK]** in <Resection/result> to display <Resection/Set h angle>.
- Select an angle mode and press **[YES]** to set the azimuth angle of the first known point as the backsight point and return to <Resection/Menu>.
- Press **[NO]** to return to <Resection/Menu> without setting the azimuth angle.

Result

Set h angle?

Mode H=Az

YES
  NO

DETAIL ReObs OK

#### Horizontal angle settings

H (set horizontal angle to measured value)/H=Az (set horizontal angle to the same value as azimuth angle)/Az (set azimuth angle only)

#### Note

- It is also possible to perform resection measurement by pressing **[RESEC]** in the third page of Observation mode.

## 14.2 Height Resection Measurement

Only Z (height) of an instrument station is determined by the measurement.

- Known points must be measured by distance measurement only.
- Between 1 and 10 known points can be measured.

### PROCEDURE

1. Select "Resection" in <Menu>.

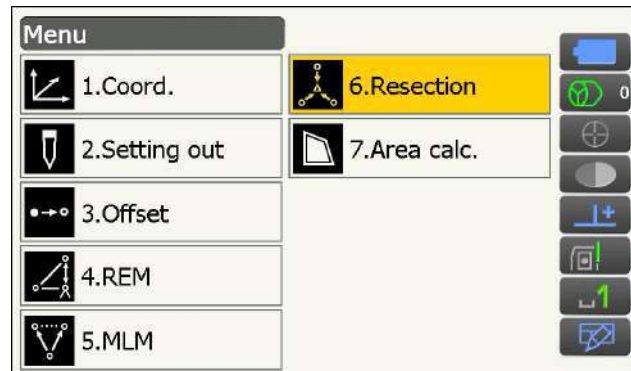

2. Select "Elevation" to display <Resection/Known point>.



3. Input the known point.

After setting the elevation and target height for the first known point press **[NEXT]** to move to the second point.

- Press **[PREV]** to return to settings for the previous point.

When all required known points have been set, press **[OK]**.

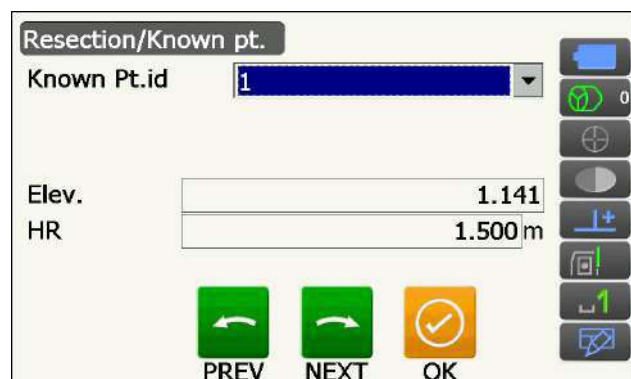

4. Sight the first known point and press **[MEAS]** to begin measurement.

The measurement results are displayed on the screen.



- If measuring two or more known points, repeat procedures 4 in the same way from the second point.



- Press **[CALC]** or **[YES]** to automatically start calculations after observations of all known points are completed.

- Instrument station elevation and standard deviation, which describes the measurement accuracy, are displayed in <Result>.

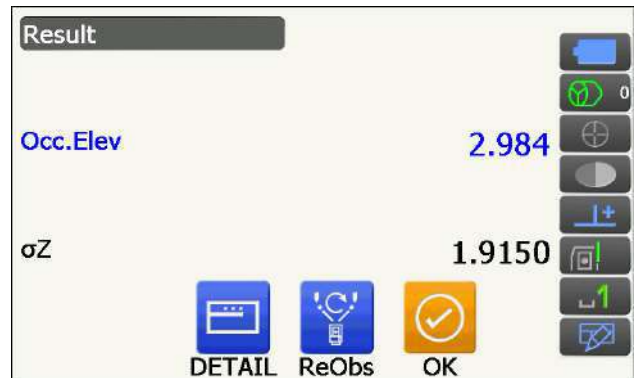

Standard deviation values for each point are displayed in <Detail>.

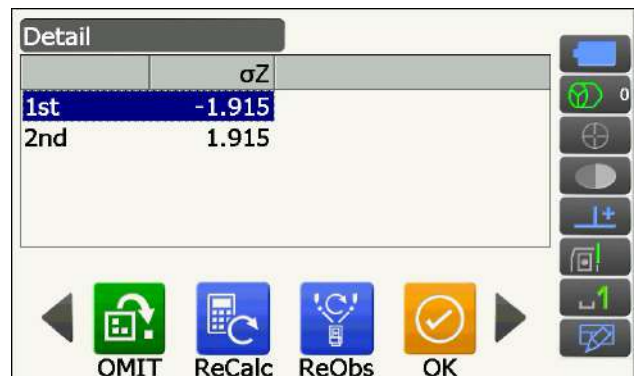

- If there are problems with the results of a point, align the cursor with that point and press **[OMIT]**. "OMIT" is displayed to the right of the point. Repeat for all results that include problems.

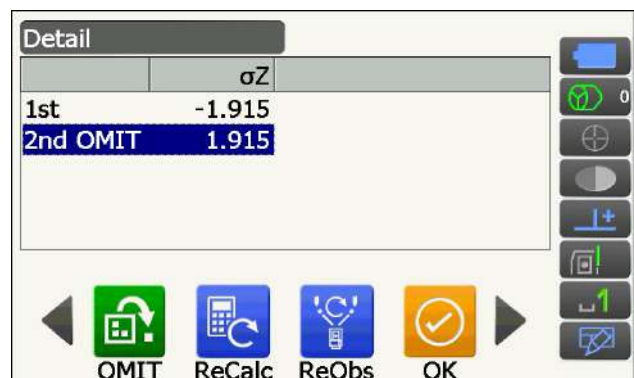

- Press **[RE CALC]** to perform calculation again without the point designated in step 7. The result is displayed. If there are no problems with the result, go to step 9. If problems with the result occur again, perform the resection measurement from step 4.

- Press **[RE\_OBS]** to measure the point designated in step 7.
- Press **[ADD]** in the second page when there is a known point that has not been observed or when a new known point is added.

If no points are designated in step 7, all the points or only the final point can be observed again.

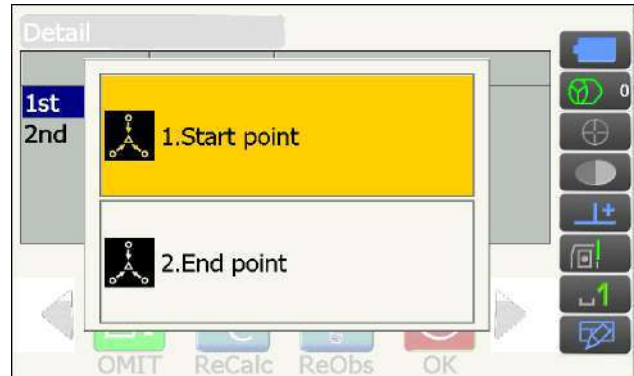

9. Press **[OK]** to finish resection measurement and return to <Resection/Menu>. Only Z (elevation) of the instrument station coordinate is set. N and E values are not overwritten.

**Resection calculation process**

The NE coordinates are found using angle and distance observation equations, and the instrument station coordinates are found using the method of least squares. The Z coordinate is found by treating the average value as the instrument station coordinates.

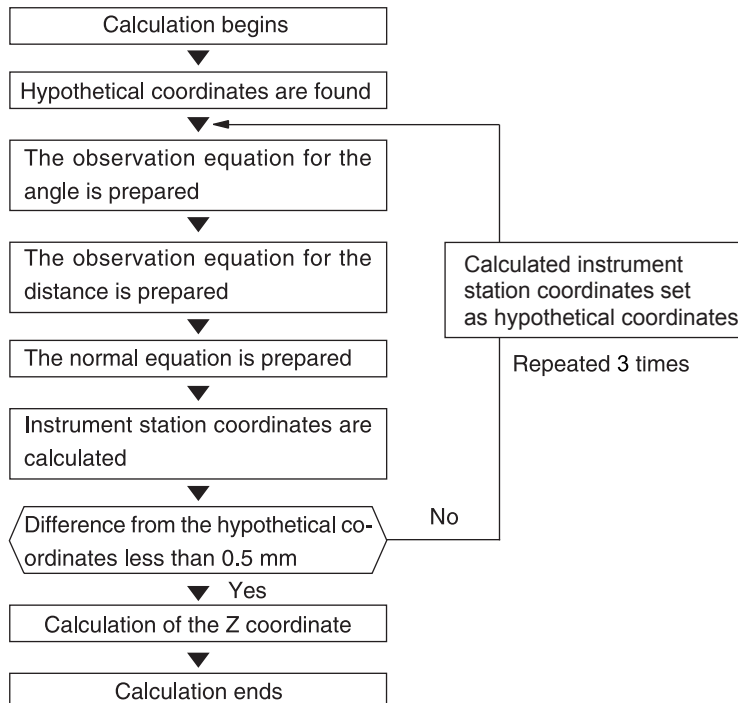

 **Precaution when performing resection**

In some cases it is impossible to calculate the coordinates of an unknown point (instrument station) if the unknown point and three or more known points are arranged on the edge of a single circle.

An arrangement such as that shown below is desirable.

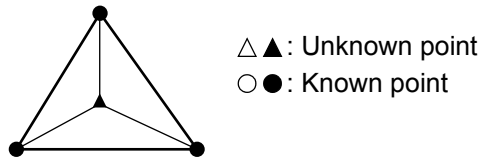

It is sometimes impossible to perform a correct calculation in a case such as the one below.

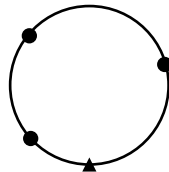

When they are on the edge of a single circle, take one of the following measures.

(1) Move the instrument station as close as possible to the center of the triangle.

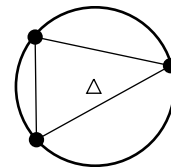

(2) Observe one more known point which is not on the circle.

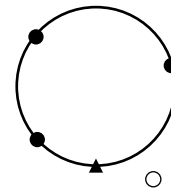

(3) Perform a distance measurement on at least one of the three points.

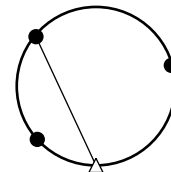

- In some cases it is impossible to calculate the coordinates of the instrument station if the included angle between the known points is too small. It is difficult to imagine that the longer the distance between the instrument station and the known points, the narrower the included angle between the known points. Be careful because the points can easily be aligned on the edge of a single circle.



# 15.SETTING-OUT MEASUREMENT

Setting-out measurement is used to set out the required point.

The difference between the previously input data to the instrument (the setting-out data) and the measured value can be displayed by measuring the horizontal angle, distance or coordinates of the sighted point.

The horizontal angle difference distance difference, and coordinate difference are calculated and displayed using the following formulae.

Horizontal difference

Displayed value (angle) = Horizontal angle of setting-out data - measured horizontal angle

Displayed value (distance) = measured horizontal distance x tan (horizontal angle of setting out data - measured horizontal angle)

Slope distance difference

Displayed value (slope distance) \* = measured slope distance - slope distance setting-out data

\* Horizontal distance or height difference can be input in the above formula.

Coordinate difference

Displayed value (coordinates)\* measured N setting-out coordinates - N coordinates of setting-out data

\* E or Z coordinates can be input in the above formula

Height difference (REM setting out measurement)

Displayed value (height) = measured REM data - REM data of setting out data

- Setting out data can be input in various modes: slope distance, horizontal distance, height difference, coordinates and REM measurement.
- It is possible to allocate Operating icons in the Setting-out measurement menu to suit various applications and the ways that different operators handle the instrument.  
 "19.12 Allocating Operating Icons"



- **[TRK On]** can only be selected on the Auto Tracking model.

## 15.1 Using the Guide Light in Setting-out Measurement

When the guide light is set to ON, the flashing speed of the light indicates the status of the instrument and can be known when the user is located at a distance from the instrument. Also, the flashing colors relative to the target indicate the direction of the instrument and allow the user to reposition the target.

☞ Turning the Guide light ON/OFF: "5.1 Basic Key Operation"

- The pattern of the guide light can be changed.

☞ "19.7 Instrument Conditions - Instrument"

### ● Guide light status and meaning

Status of instrument

Light status	Meaning
Slow flashing (Red and green simultaneously)	Waiting
	Search error (error screen only)
Fast flashing (Red and green simultaneously)	Searching in progress
	Measuring (continuous measurement)
	Returned signal checking in progress
	Auto Tracking in progress (Auto Tracking model only)
	Auto Tracking in predicted direction (Auto Tracking model only)
Green and red alternate flashing	Distance measurement error (no signal, sighting error)
	"Prism wait"

Indication for positioning target during setting-out measurement

Light status	Meaning
Increased flashing speed	(From position of poleman) Move target toward instrument
Decreased flashing speed	(From position of poleman) Move target away from instrument
Fast flashing	Target is at correct distance
Red	(From position of poleman) Move target left
Green	(From position of poleman) Move target right
Red and Green	Target is at correct horizontal position

## 15.2 Distance Setting-out Measurement

The point is to be found based on the horizontal angle from the reference direction and the distance from the instrument station.

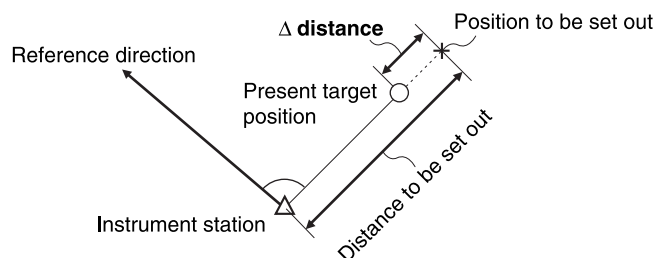

**PROCEDURE**

1. Select "Setting out" in <Menu> to display <Setting out>.

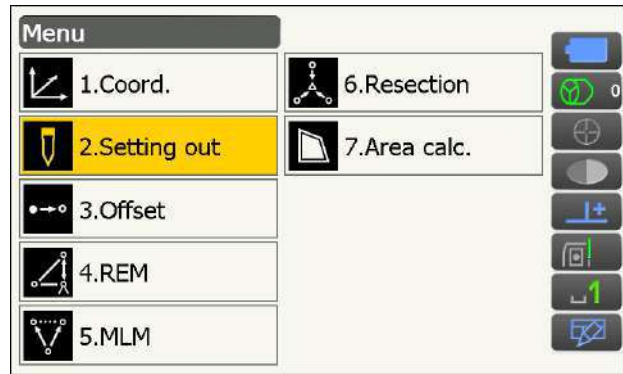

2. Set the instrument station and the backsight station to define the reference direction. Select "Occupy setup" in <Setting out>. Enter data for the instrument station and press [OK] to move to Backsight setup.

☞ "13.1 Entering Instrument Station Data"

Reference Direction

Instrument station

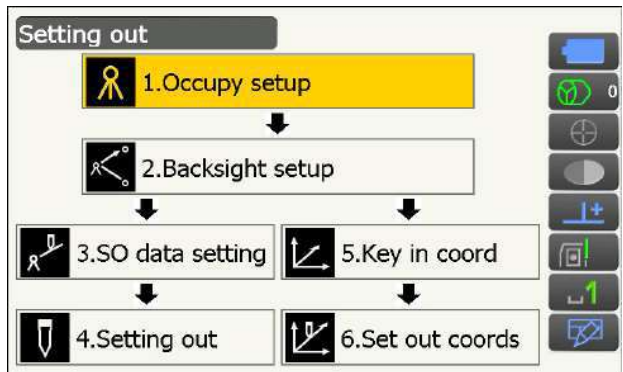

3. Set the azimuth angle for the backsight station. Press [OK] to return to <Setting out>.

☞ "13.2 Azimuth Angle Setting"

4. Select "SO data setting" in <Setting out>.

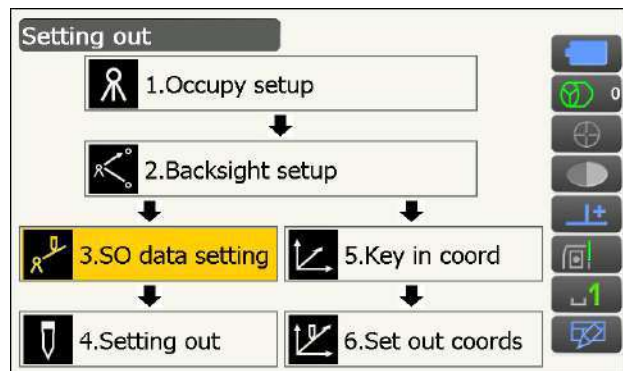

In the distance mode that conforms to your measurement requirements, enter the included angle between the reference point and the setting-out point in "SO.H.ang", and the distance (slope distance, horizontal distance or height difference) from the instrument station to the position to be set out in "SO.Sdist". Press [OK] to set the input values.



- Each time **[Shvr]** is pressed, the distance mode changes from "SD" (slope distance), "HD" (horizontal distance), "VD" (height difference), and "Ht." (REM).
- Press **[COORD]** and input coordinates in <Key in coord>. The angle and distance from these coordinates to the position to be set out will be calculated.

5. Press **[H.TURN]** to automatically rotate the instrument until the difference in horizontal angle to the setting out point reads 0°.



- Switch the Operating icons and press **[CNFG]** to set setting out accuracy. When the position of the target is within this range both arrows will be displayed to indicate that the target position is correct.

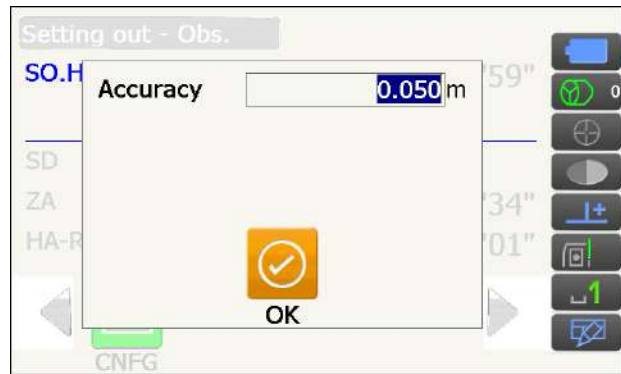

6. Position the target on the line of sight and press **[MEAS]** to begin distance measurement. The distance and direction to move the target until the setting out point is located is displayed on the instrument. The sighting point measurement results (currently installed position of the target) are displayed.

- Movement indicator (Red indicates that target position is correct)
  - ◁ : (Viewed from instrument) Move target to the left
  - ▷ : (Viewed from instrument) Move target to the right
  - ◁▷ : Target position is correct
  - ▼ : (Viewed from instrument) Move target closer
  - ▲ : (Viewed from instrument) Move target away
  - ▲▼ : (Viewed from instrument) Target position is correct

Arrows indicate direction to move

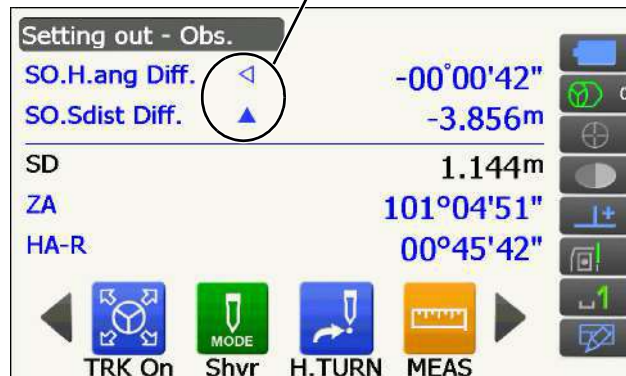

- ▲▲▲ : Move target upward
- ▼▼▼ : Move target downward
- ▲▼▼ : Target position is correct

- Each time **[Shvr]** is pressed, the distance mode changes from slope distance, horizontal distance, height difference and slope distance (REM).
- Tap the screen title to display popup and select "Graphic" display to show the current position on a graph.

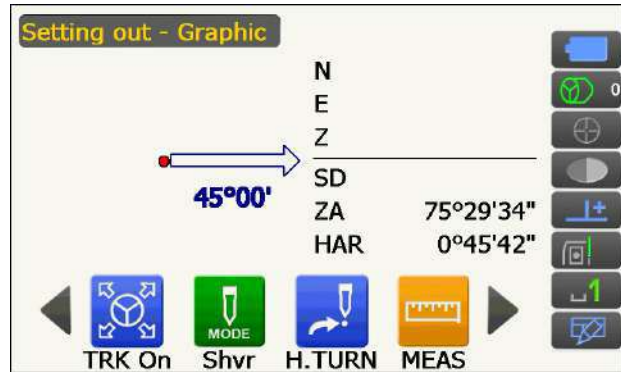

7. Move the target until the distance to the setting-out point reads 0 m. When the target is moved within the allowed range, all distance and position arrows are displayed.

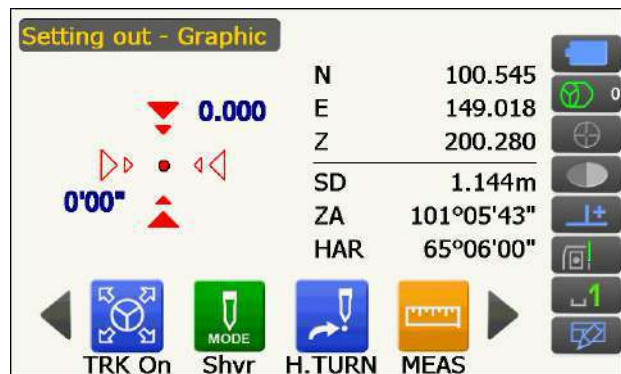

8. Press **{ESC}** to return to <Setting out>. Set the next setting out point to continue setting out measurement.

### 15.3 Coordinates Setting-out Measurement

After setting the coordinates for the point to be set out, the instrument calculates the setting-out horizontal angle and horizontal distance. By selecting the horizontal angle and then the horizontal distance setting-out functions, the required coordinate location can be set out.

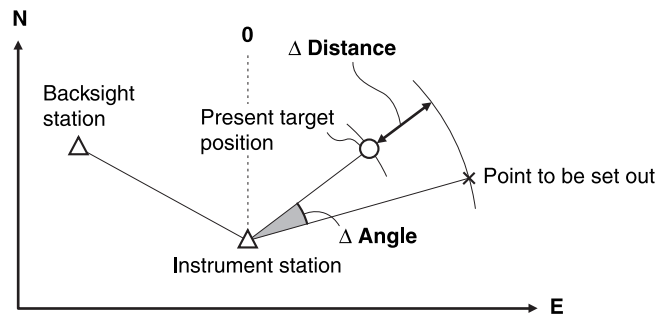

- Previously recorded setting-out points can be placed in order. Up to 50 points can be recorded.
- To find the Z coordinate, attach the target to a pole etc. with the same target height.

#### PROCEDURE

1. Select "Setting out" in <Menu> to display <Setting out>.
2. Set the instrument station, and, if necessary, enter data for Backsight setup.  
 "15.2 Distance Setting-out Measurement" steps 2 to 3

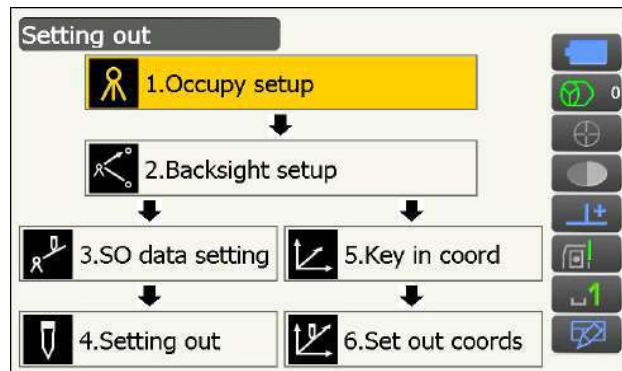

3. Select "Key in coord" in <Setting out>.

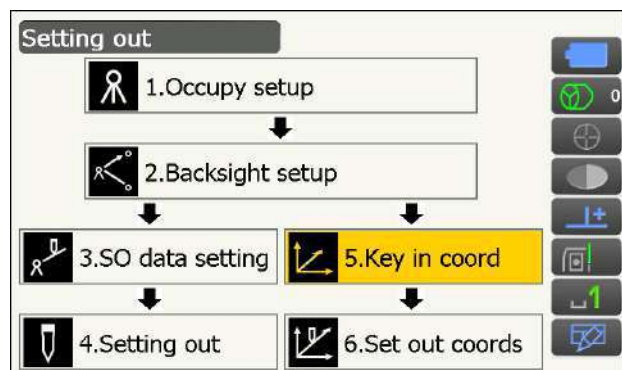

Record all the setting-out points (includes setting-out points you will measure from now).

Press **[ADD]** to record new data.

- Switch the Operating icons and press **[DEL]** to delete the selected setting out point.
- Press **[DELALL]** to delete all setting out points.



4. Select a setting-out point in the first screen of step 3 and press **[OK]** to display <Set out Coords>.

5. Position the target on the line of sight and press **[H.TURN]** to automatically rotate the instrument until the angle of the setting out point reads 0°. Press **[MEAS]** to begin distance measurement. The distance and direction to move the target until the setting out point is located is displayed on the instrument. The sighting point measurement results (currently installed position of the target) are displayed.



- Tap the screen title to display popup and "NEZ" display can be selected.



- Tap the screen title to display popup and "Graph 1" display or "Graph 2" display can be selected.

The Graph 1 : the current position of the mirror and the direction to the setting out point from this position.

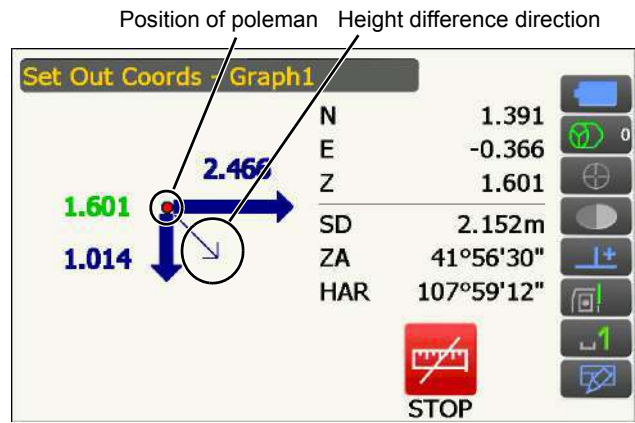

The Graph 2 : the position of the setting out point (square) and the current location of the mirror (circle).

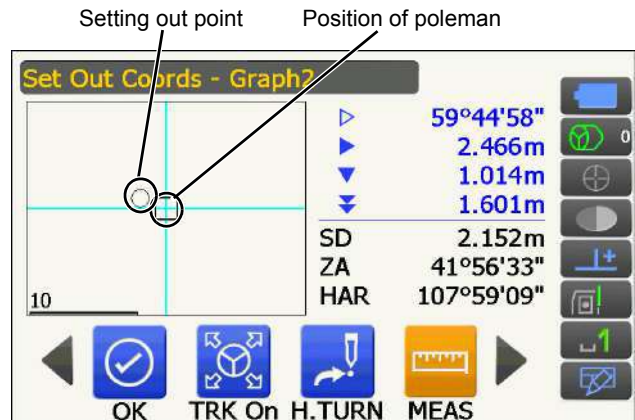

Move the target to find the correct distance (0 is displayed) to the setting out point.

☞ Movement indicators: "15.2 Distance Setting-out Measurement" step 6





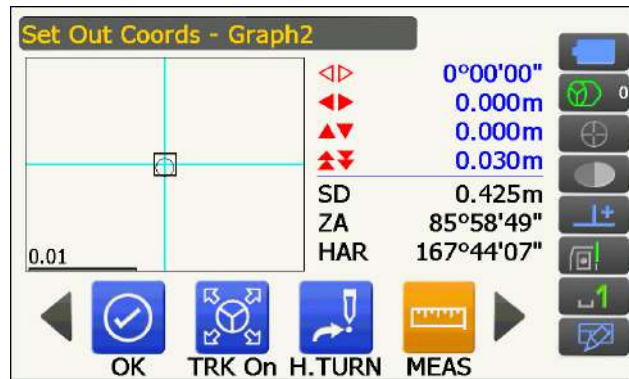

6. Press **[OK]** to return to <Key in coord>. Set the next setting out point to continue setting out measurement.

## 15.4 REM Setting-out Measurement

To find a point where a target cannot be directly installed, perform REM setting-out measurement.

 "12.5 REM Measurement"

### PROCEDURE

1. Install a target directly below or directly above the point to be found. Then use a measuring tape etc. to measure the target height (height from the survey point to the target).
2. Select "Setting out" in <Menu> to display <Setting out>.
3. Set the instrument station, and, if necessary, enter data for Backsight setup.  
 "15.2 Distance Setting-out Measurement" steps 2 to 3
4. Select "SO data setting" In <Setting out> to display <SO data setting>. Press **[Shvr]** until the distance input mode is "SO.Height.". Input height from the surveying point to the position to be set out in "SO.Height". If necessary, input the angle to the point to be set out. Enter values and press **[OK]**.



5. Press **[H.TURN]** to automatically rotate the instrument until the angle of the setting out point reads 0°.



6. Sight the target and press **[MEAS]**. Measurement begins and the measurement results are displayed.



7. Switch the Operating icons and press **[REM]** to start REM measurement. The distance (height difference) and direction to move the target until the sighting point and setting out point are located is displayed on the instrument.

Arrows indicate direction to move

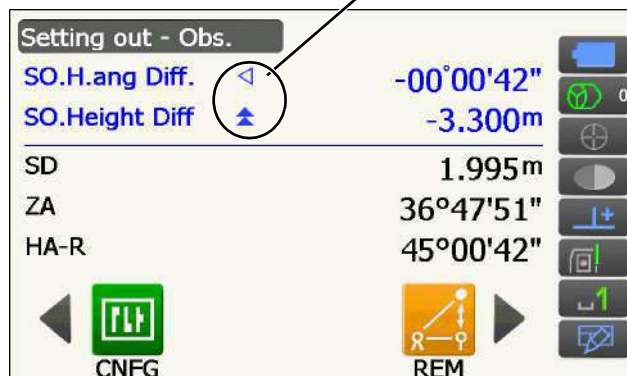

Press **[STOP]** to stop measuring.

Find the setting-out point by moving the telescope until "SO.Height Diff" reads 0 m.

- Movement indicator (Red indicates that target position is correct)

- ▲▲ : Move the telescope near the zenith
- ▼▼ : Move the telescope near the nadir
- ▼▲ : Telescope direction is correct

For details of other movement indicators:  
"15.2 Distance Setting-out Measurement"  
step 6

- Tap the screen title to display popup and "Graphic" display can be selected.

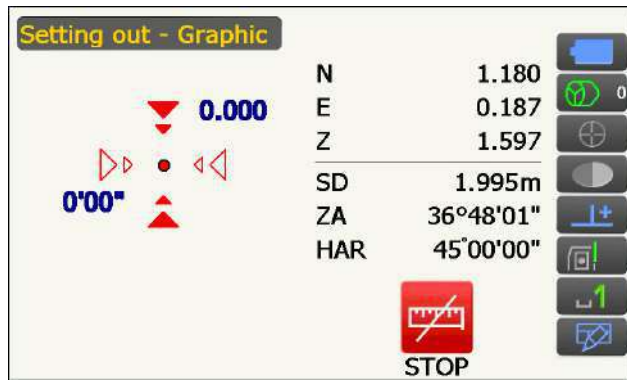

8. Press **{ESC}** to return to <SO data setting>.

# 16.OFFSET MEASUREMENT

Offset measurements are performed in order to find a point where a target cannot be installed directly or to find the distance and angle to a point which cannot be sighted.

- It is possible to find the distance and angle to a point you wish to measure (target point) by installing the target at a location (offset point) a little distance from the target point and measuring the distance and angle from the survey point to the offset point.
- The target point can be found in the three ways explained in this chapter.
- The instrument station and backsight must be set before the coordinates of an offset point can be found. Station and backsight setup can be performed in the Offset menu.  
☞ Occupy setup: "13.1 Entering Instrument Station Data", Backsight setup: "13.2 Azimuth Angle Setting".
- It is possible to allocate Operating icons in measurement menus to suit various applications and the ways that different operators handle the instrument.  
☞ "19.12 Allocating Operating Icons"

## 16.1 Offset Single-distance Measurement

Finding it by entering the horizontal distance from the target point to the offset point.

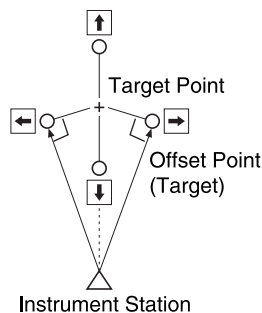

- When the offset point is positioned to the left or right of the target point, make sure the angle formed by lines connecting the offset point to the target point and to the instrument station is almost 90°.
- When the offset point is positioned in front of or behind the target point, install the offset point on a line linking the instrument station with the target point.

### PROCEDURE

1. Set the offset point close to the target point and measure the distance between them, then set up a prism on the offset point.
2. Select "Offset" in <Menu> to display <Offset>.

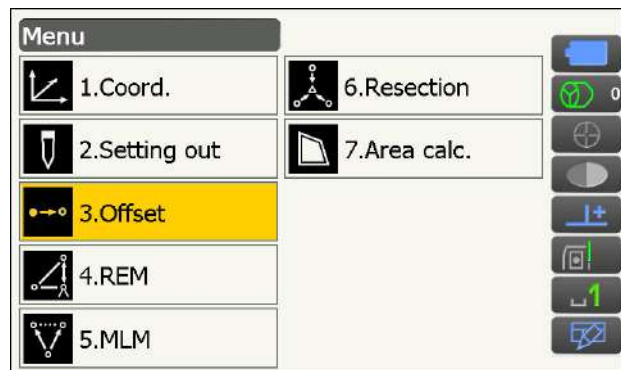

- Set the instrument station and the backsight station to define the reference direction. Select "Occupy setup" in <Offset>. Enter data for the instrument station and press **[OK]** to move to Backsight setup.

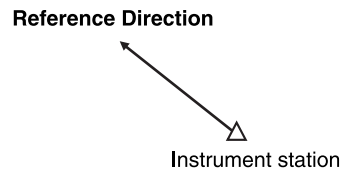

[F3] "13.1 Entering Instrument Station Data"

- Set the azimuth angle for the backsight station. Press **[OK]** to return to <Offset>.

[F3] "13.2 Azimuth Angle Setting"

- Select "OffsetDIST".

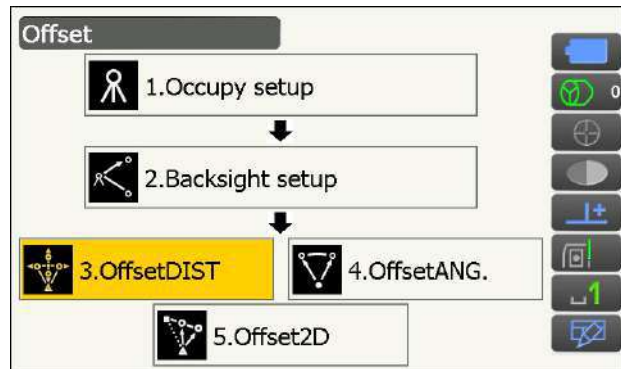

Input the following items.

- Direction of the offset point.
- Horizontal distance from the target point to the offset point.

• Direction of offset point

- ← : On the left of the target point.
- : On the right of the target point.
- ↓ : Closer than the target point.
- ↑ : Beyond the target point.

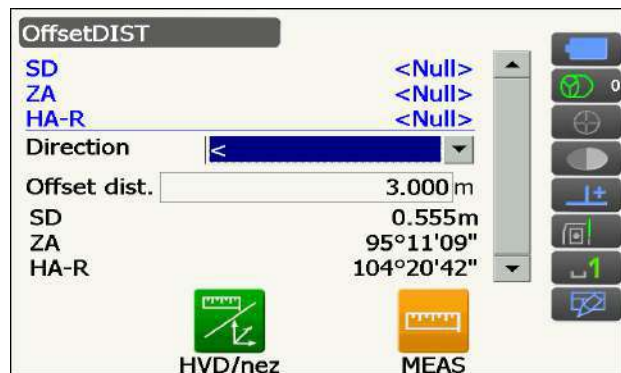

- Sight the offset point and press **[MEAS]** in the screen of step 5 to start measurement. Press **[STOP]** to stop the measurement. The measurement results are displayed.

• Press **[HVD/nez]** to switch results for the target point between distance/angle values and coordinate/elevation values.

Results for target point

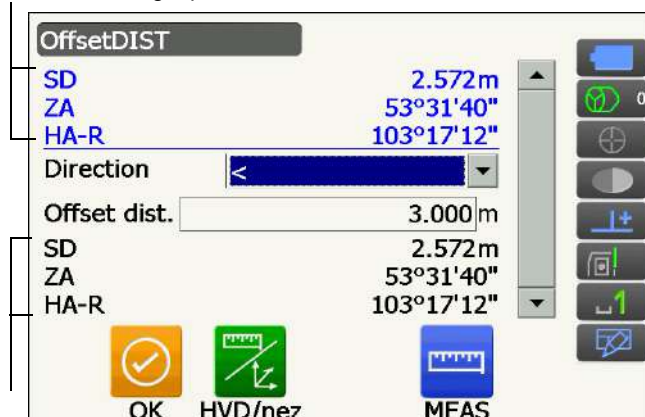

Results for offset point

## 16.2 Offset Angle Measurement

Sighting the direction of the target point to find it from the included angle.

Install offset points for the target point on the right and left sides of and as close as possible to the target point and measure the distance to the offset points and the horizontal angle of the target point.

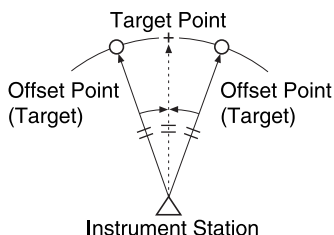

### PROCEDURE

1. Set the offset points close to the target point (making sure the distance from the instrument station to the target point and the height of the offset points and the target point are the same), then use the offset points as the target.
2. Select "Offset" in <Menu> to display <Offset>.
3. Select "OffsetANG."

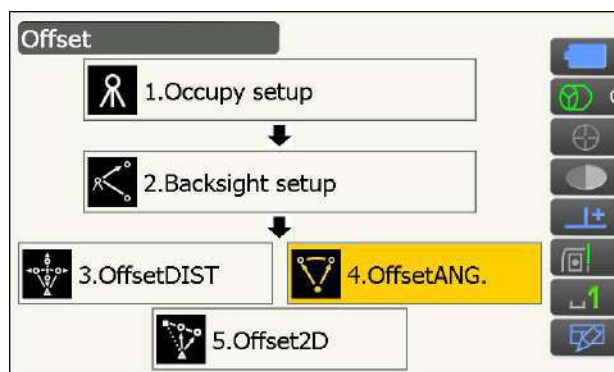

4. Sight the offset point and press **[MEAS]** to start measurement.  
Press **[STOP]** to stop the measurement.
5. Sight the target point and press **[H.ANG]**.



The result of the target point is displayed.

- Press **[HVD/nez]** to switch results for the target point between distance/angle values and coordinate/elevation values.

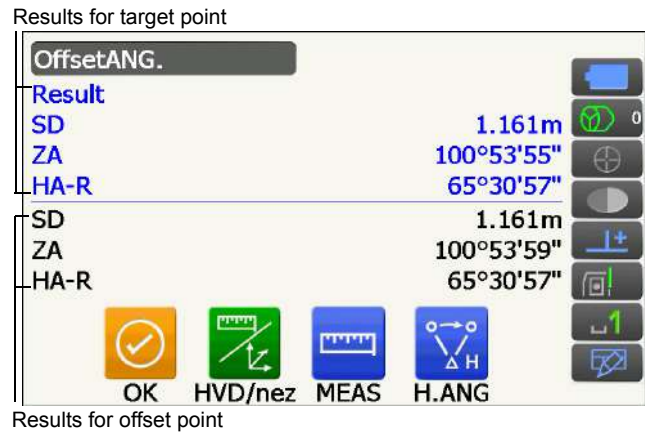

6. Press **[OK]** in the screen in step 5 to return to <Offset>.

### 16.3 Offset Two-distance Measurement

By measuring the distances between the target point and the two offset points. Install two offset points (1st target and 2nd target) on a straight line from the target point, observe the 1st target and 2nd target, then enter the distance between the 2nd target and the target point to find the target point.

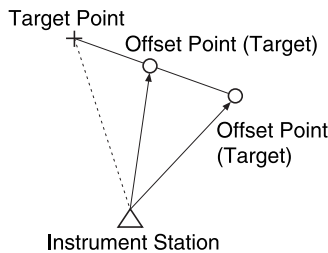

- It is possible to make this measurement easily using the optional equipment: the 2-point target (2RT500-K). How to use 2-point target (2RT500-K)

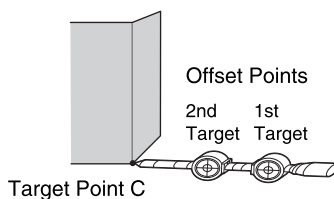

- Install the 2-point target with its tip at the target point.
- Face the targets toward the instrument.
- Measure the distance from the target point to the 2nd target.
- Make sure reflector type is set correctly.

"19.3 Observation Conditions - Reflector (Target)"

**Note**

- An operation error may occur and the instrument may not be able to find the prism depending on the target installation status or measuring conditions. In this case, manually sight the target.

"10.1 Auto Pointing and Auto Tracking Settings"

## PROCEDURE

1. Install two offset points (1st target, 2nd target) on a straight line from the target point and use the offset points as the target.
2. Select "Offset" in <Menu> to display <Offset>.
3. Select "Offset2D".

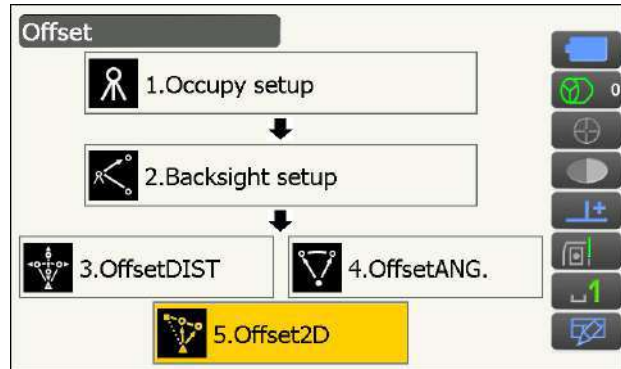

4. Press **[CNFG]** and input the distance from the 2nd target to the target point in "Offset dist.". Set reflector settings and press **[OK]** to confirm.

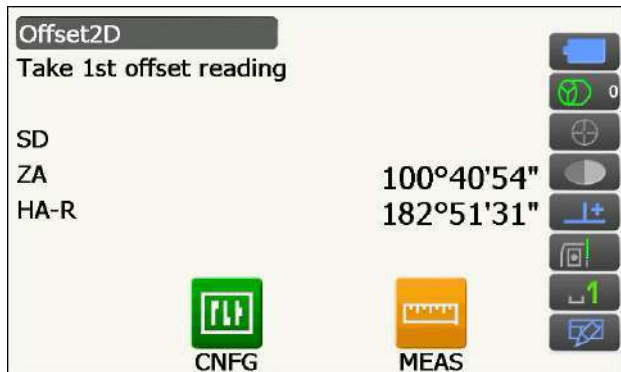

5. Sight the 1st target and press **[MEAS]** to start measurement.  
Press **[STOP]** to stop the measurement.





The measurement results are displayed. Press **[YES]** to confirm.

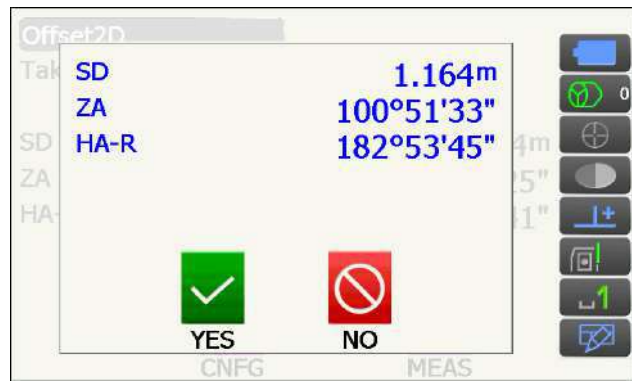

6. Sight the 2nd target and press **[MEAS]** to start measurement.  
Press **[STOP]** to stop the measurement. The measurement results are displayed.



7. Press **[YES]** in the measurement result screen of the 2nd target to display results for the target point.

Press **[HVD/nez]** to switch results for the target point between distance/angle values and coordinate/elevation values.

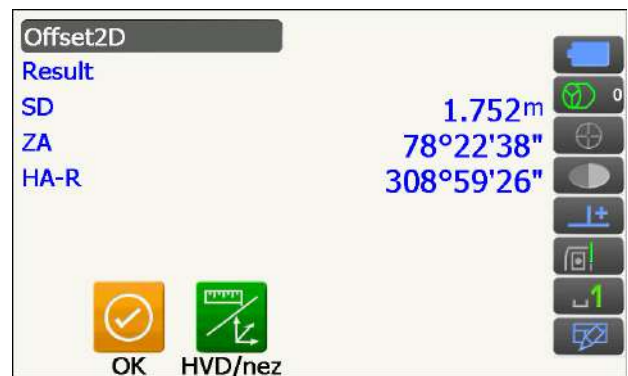

8. Press **[OK]** in the screen in step 7 to return to <Offset>.

# 17.MISSING LINE MEASUREMENT

Missing line measurement is used to measure the slope distance, horizontal distance, and horizontal angle to a target from the target which is the reference (starting point) without moving the instrument.

- It is possible to change the last measured point to the next starting position.
- Measurement results can be displayed as the gradient between two points.

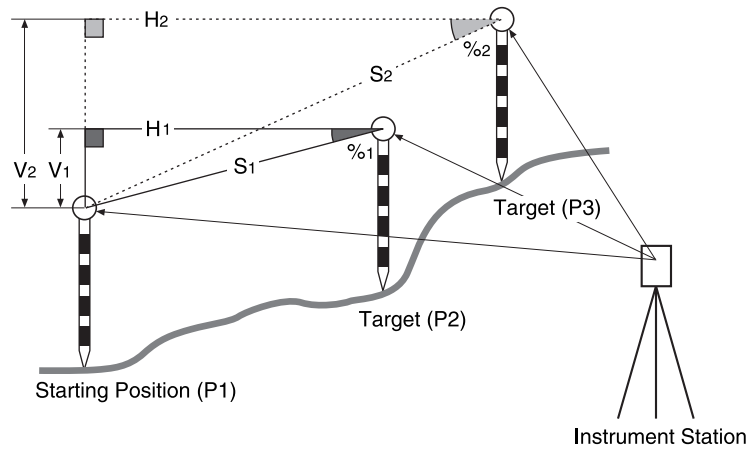

- It is possible to allocate Operating icons in measurement menus to suit various applications and the ways that different operators handle the instrument.  
[☞ "19.12 Allocating Operating Icons"](#)

## 17.1 Measuring the Distance between 2 or more Points

### PROCEDURE

1. Select "MLM" in <Menu>.



- When measurement data already exists, the screen of step 3 is displayed and measurement starts.

2. Sight the starting position and press [MEAS] to start measurement.  
Press [STOP] to stop measurement.

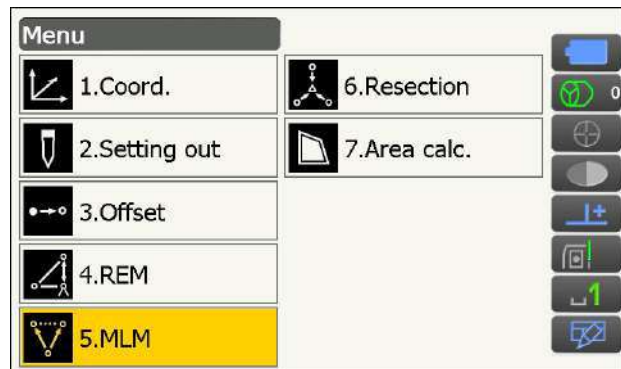

3. Sight the target and press **[MLM]** to begin observation.

Press **[STOP]** to stop measurement.

Slope distance, grade, horizontal distance and height difference between the target and the starting position are displayed.



4. Sight the next target and press **[MLM]** to continue observation. Slope distance, grade, horizontal distance and height difference between multiple points and the starting position can be measured this way.

- Press **[MEAS]** to re-observe the starting position. Sight the starting position and press **[MEAS]**.
- When **[MOVE]** is pressed, the last target measured becomes the new starting position to perform missing line measurement of the next target.

"17.2 Changing the Starting Point"

Results for measurement between starting position and second target

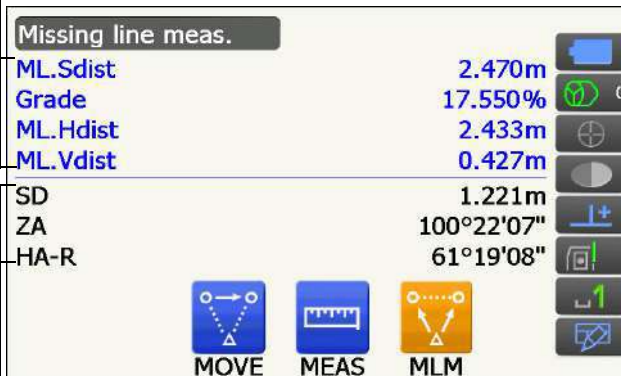

Results for current point

5. Press **{ESC}** to end missing line measurement.

## 17.2 Changing the Starting Point

It is possible to change the last measured point to the next starting position.

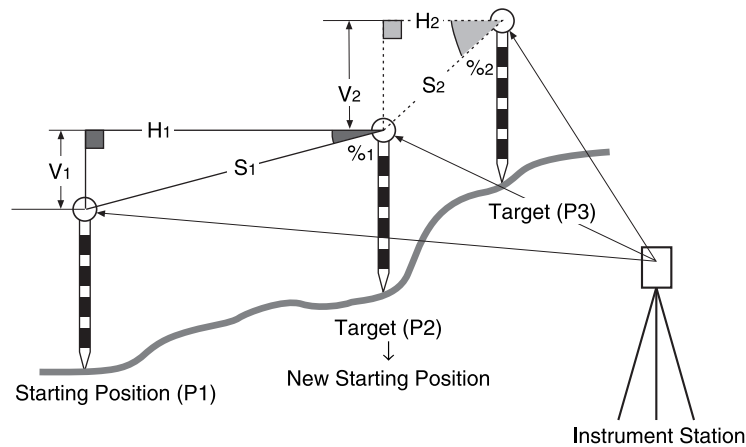

### PROCEDURE

1. Observe the starting position and target following steps 1 to 4 in "17.1 Measuring the Distance between 2 or more Points".
2. After measuring the targets, press **[MOVE]**.

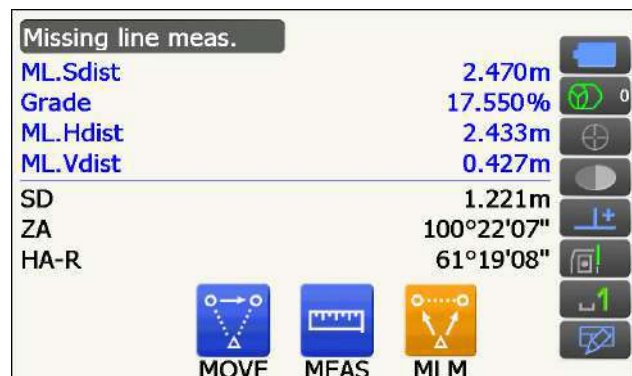

Press **[YES]** in the confirmation message window.

- Press **[NO]** to cancel measurement.

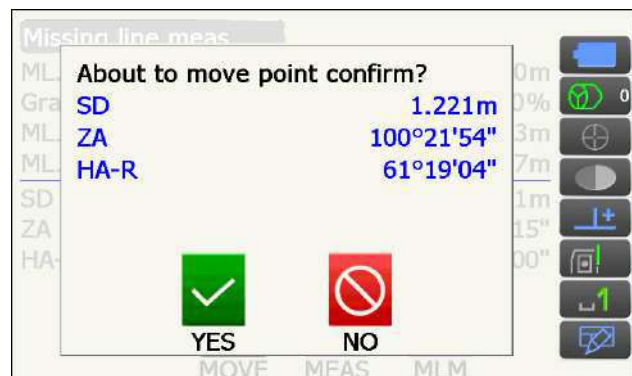

3. The last target measured is changed to the new starting position.
4. Perform missing line measurement following steps 4 to 5 in "17.1 Measuring the Distance between 2 or more Points".

# 18.SURFACE AREA CALCULATION

You can calculate the area of land (slope area and horizontal area) enclosed by three or more known points on a line by inputting the coordinates of the points

Input

Coordinates: P1 (N1, E1, Z1)  
...  
P5 (N5, E5, Z5)

Output

Surface area: S (horizontal area and slope area)

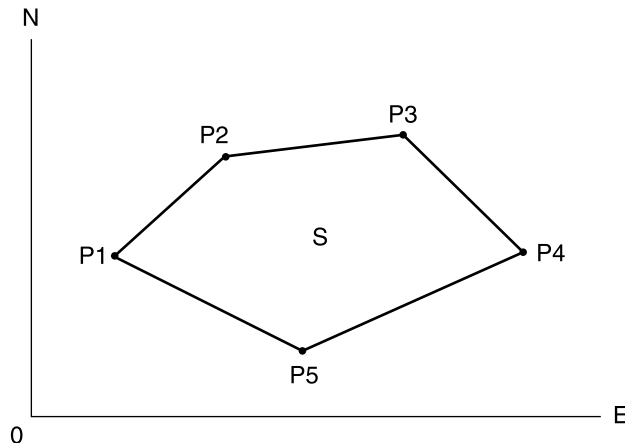

- Number of specified coordinate points: 3 or more, 30 or less
- It is possible to allocate Operating icons in measurement menus to suit various applications and the ways that different operators handle the instrument.  
☞ "19.12 Allocating Operating Icons"



- An error will occur if only two points (or less) are entered when specifying an enclosed area.
- Be sure to observe points on an enclosed area in a clockwise or counterclockwise direction. For example, the area specified by entering point numbers 1, 2, 3, 4, 5 or 5, 4, 3, 2, 1 implies the same shape. However, if points are not entered in numerical order, the surface area will not be calculated correctly.



## Slope area

The first three points specified are used to create the surface of the slope area. Subsequent points are projected vertically onto this surface and the slope area calculated.

## PROCEDURE Surface area calculation by measuring points

1. Select "Area calc." in <Menu>

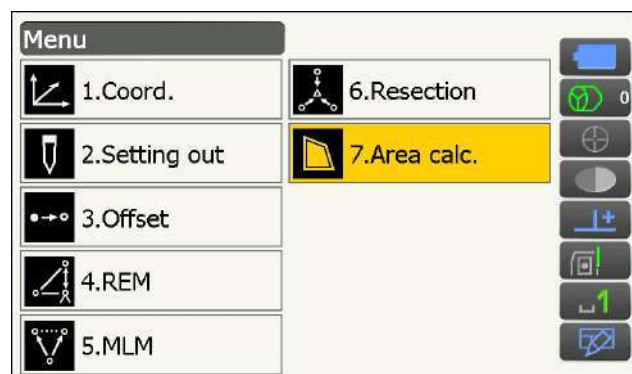

2. Press **[OBS]** to display <Area calculation/obs.>.

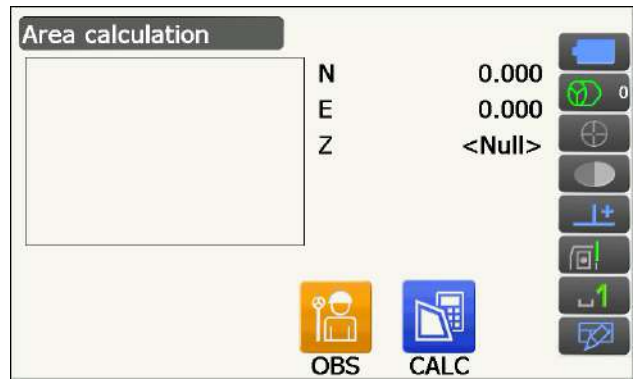

Sight the first point on the line enclosing the area, and press **[MEAS]**.

Measurement begins and the measured values are displayed. Press **[STOP]** to stop measuring.



3. The measurement results are displayed. Press **[YES]** to confirm.



The value of point 1 is set in "Pt\_01".

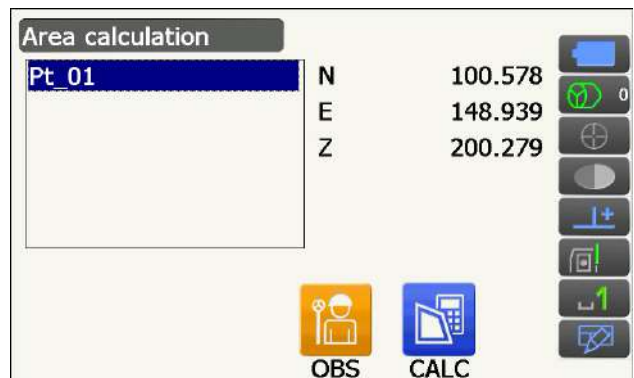

4. Repeat steps 2 to 3 until all points have been measured. Points on an enclosed area are observed in a clockwise or counterclockwise direction. For example, the area specified by entering point numbers 1, 2, 3, 4, 5 or 5, 4, 3, 2, 1 implies the same shape.

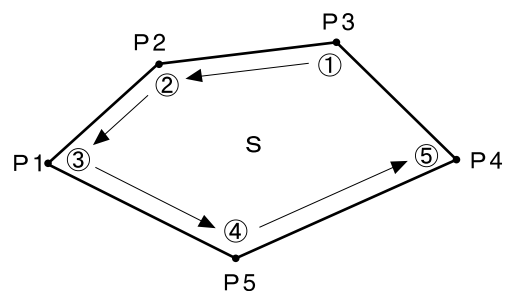

5. Press **[CALC]** to display the calculated area.

The image shows two screenshots from a surveying application. The top screenshot is titled 'Area calculation' and displays a list of points: Pt\_01, Pt\_02, Pt\_03, Pt\_04, and Pt\_05 (which is highlighted). To the right of the list, the coordinates for the selected point are shown: N 100.565, E 151.020, and Z 200.281. Below the list are two buttons: 'OBS' (orange) and 'CALC' (blue). The bottom screenshot is titled 'Area/result' and displays the calculated area values: 'Points' 3, 'S.Area' 2.473m<sup>2</sup>, and 'H.Area' 0.553m<sup>2</sup>. Below these values is an 'OK' button (orange with a checkmark). Both screenshots feature a vertical toolbar on the right side with various navigation and function icons.

Point	N	E	Z
Pt_01	100.565	151.020	200.281
Pt_02			
Pt_03			
Pt_04			
Pt_05			

  

Category	Value
Points	3
S.Area	2.473m <sup>2</sup>
H.Area	0.553m <sup>2</sup>

6. Press **[OK]** to return to <Area calculation>. Press **{ESC}** twice to quit area calculation.

# 19.CHANGING THE SETTINGS

This section explains the contents of parameter settings in Config mode and how to change these settings. Each item can be changed to meet your measurement requirements. <Configuration> can be accessed by tapping Config mode icon in Starkey mode.

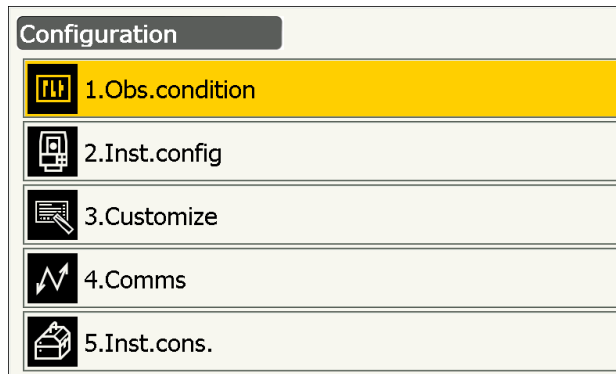

The following items in Configuration mode are explained in other chapters.

Observation condition - Search/Track settings

☞ "10.1 Auto Pointing and Auto Tracking Settings"

Communication settings

☞ "9. CONNECTING TO EXTERNAL DEVICES"

Instrument configurations

☞ "21.2 Tilt Sensor", "21.4 Collimation", "21.5 Image Sensor Reticle"

## 19.1 Observation Conditions - Angle/Tilt

Select "Obs.condition" in <Configuration> and select "Angle/Tilt".

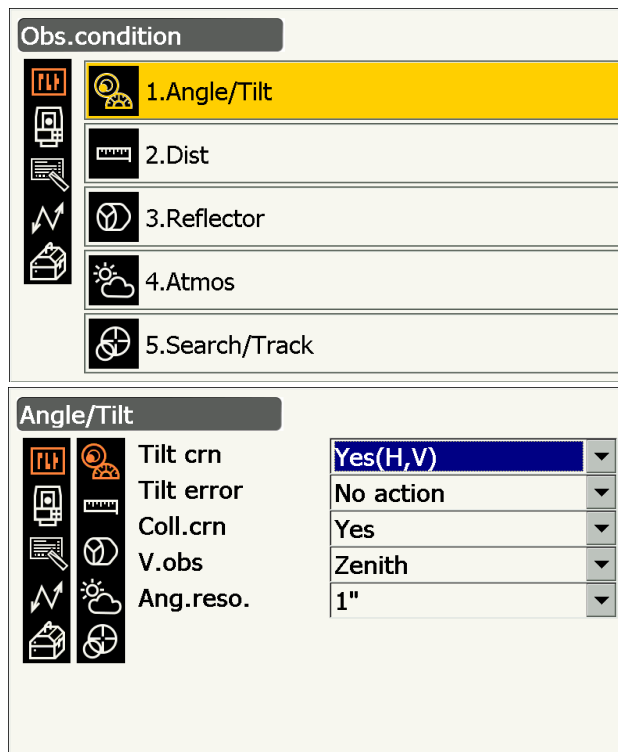

### Items set and options (\*: Factory setting)

- Tilt crn (tilt correction) ☐ : Yes (H,V)\*/No/Yes (V)
- Tilt error : No action\*/Go to <Tilt> (electric circular level is displayed)
- Coll.crn. (collimation correction) ☐ : No/Yes\*
- V.obs (vertical angle display method) ☐ : Zenith\*/Horiz/Horiz ±90



Ang.reso. (Angle resolution) : iX-1001/1002/501/502: 0.5", 1"\*  
iX-1003/1005/503/505: 1"\*, 5"

### Automatic tilt angle compensation mechanism

The vertical and horizontal angles are automatically compensated for small tilt errors using the 2-axis tilt sensor.

- Read the automatically compensated angles when the display has stabilized.
- The horizontal angle error (vertical axis error) fluctuates according to the vertical axis, so when the instrument is not completely leveled, changing the vertical angle by rotating the telescope will cause the displayed horizontal angle value to change.
- Compensated horizontal angle = Measured horizontal angle + Tilt in angle/tan (Vertical angle)
- When the telescope is directed close to the zenith or nadir angle, tilt compensation is not applied to the horizontal angle.

### Collimation correction



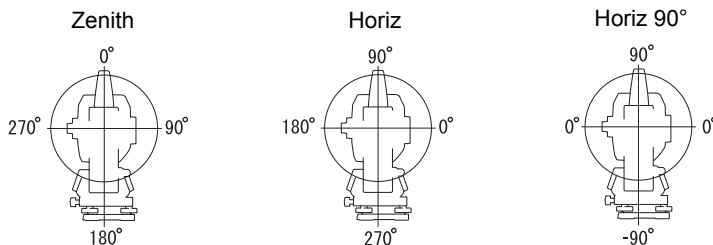

The instrument has a collimation correction function that automatically corrects horizontal angle errors caused by horizontal axis and leveling axis errors. Normally set this item to "Yes".

### V mode (vertical angle display method)









## 19.2 Observation Conditions - Dist







Select "Obs.condition" in <Configuration> and select "Dist".

Obs.condition	
	1.Angle/Tilt
	<b>2.Dist</b>
	3.Reflector
	4.Atmos
	5.Search/Track

Dist		
	Dist.mode	Fine 'R'
	Dist.mode	Sdist
	Hdist	Ground
	C&R crn.	Yes(K:Voluntary)
	Ref.Index	0.000
	Sea level crn	No
	Scale	1.00000000
	Coordinates	N-E-Z
	Dist.reso.	1mm
	Tracking reso.	10mm
	EDM ALC	Hold

**Items set and options (\*: Factory setting)**

Dist. mode (Distance measurement mode):	Fine 'R'*/Fine AVG n= 1(Setting: 1 to 9 times)/Fine 'S'/Rapid 'R'/Rapid 'S'/Tracking/Road 
Distance mode	: Sdist (slope distance)*/Hdist (horizontal distance)/ V.dist (height difference)
Hdist 	: Ground*/Grid
C&R crn.	: No/Yes(K=0.142)/Yes(K=0.20)*/Yes(K:Voluntary)
Ref.Index	: -10.000 to 15.000 (0.000*)
Sea level crn. (Sea level correction) 	: Yes/No*
Scale factor 	: 0.50000000 to 2.00000000 (1.00000000*)
Coordinates	: N-E-Z*/E-N-Z
Dist.reso. (Distance resolution) 	: 0.1 mm/1 mm*
Tracking reso. (Tracking resolution) 	: 1 mm/10 mm*
EDM ALC 	: Free*/Hold

- Input the number of the times for "Fine AVG" distance measurement mode using the numeric keys.
- "Road" in "Dist. mode" is displayed only when "N-Prism" is selected in <Reflector>.
-  "Observation Conditions - Reflector (Target)"
- "Ref.Index" is displayed only when "C&R crn." is set to "Yes(K:Voluntary)". An arbitrary index can be input.

 **Road**

"Road" is the specialized distance mode to measure road surface etc. by sighting obliquely and to obtain rough measurement values. "Road" can be selected only when "Reflector type" is set to "N-Prism". Even if "Road" is selected, "Distance mode" changes to "Tracking" automatically when "Reflector type" is set to other than "N-Prism".

 **Hdist**

The instrument calculates horizontal distance using slope distance values. Horizontal distance display can be selected from the following methods.

Ground: Distance without sea level correction

Grid: Distance on the rectangular coordinates system calculated by sea level correction (When "Sea level crn." is set to "No", Distance on the rectangular coordinates system without correction)

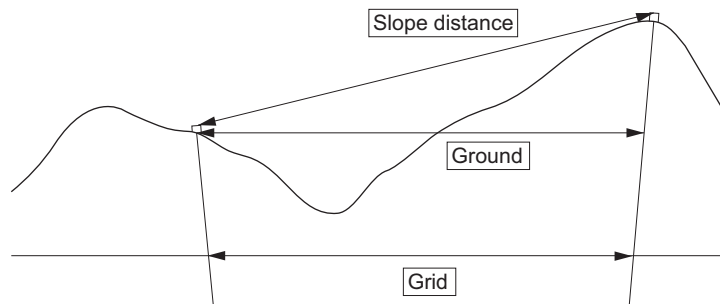
 **Sea level correction**

The instrument calculates horizontal distance using slope distance values. As this horizontal distance does not take height above sea level into consideration, performing spherical correction is recommended when measuring at high altitudes. Spherical distance is calculated as follows.

$$\text{Spherical distance} = \frac{R - H_a}{R} \times d_1$$

Where: R = radius of the spheroid (6371.000 m)  
 $H_a$  = averaged elevation of the instrument point and target point  
 $d_1$  = horizontal distance

### **Scale factor**

iX calculates horizontal distance and coordinates of a point using measured slope distance. If scale factor has been set, scale correction is carried out during calculation. When scale factor is set to "1.00000000", the horizontal distance is not corrected.

Corrected horizontal distance (s) = Horizontal distance x Scale factor

### **Dist.reso. (Distance resolution)**

Select distance resolution of fine measurement. Distance resolution of rapid and tracking measurement will shift with this setting.

### **Tracking reso. (Tracking resolution)**

Select distance resolution of tracking measurement and road measurement (N-prism only). Set this setting depending on the measurement purpose like measuring a moving target.

### **EDM ALC**

Set the light receiving status of the EDM. While carrying out continuous measurement, set this item according to the measurement conditions.

- When EDM ALC is set to "Free," the instrument's ALC will be automatically adjusted if an error occurs as a result of the amount of light received. Set to "Free" when the target is moved during measurement or different targets are used.
- When "Hold" is set, the amount of light received will not be adjusted until continuous measurement is completed.
- If an obstacle intermittently obstructs the light beam during continuous measurement and the "Signal off" error occurs, each time the obstruction occurs it takes some time for the amount of light received to be adjusted and the measurement value displayed. Set to "Hold" when the light beam used for measurement is stable but is frequently obstructed by obstacles such as people, cars, or tree branches etc. preventing measurement from being performed.

#### **Note**

- When the distance measurement mode is set to "Tracking" (target is moved during distance measurement) the EDM ALC will be adjusted regardless of the EDM ALC setting.

### 19.3 Observation Conditions - Reflector (Target)

Select "Obs.condition" in <Configuration> and select "Reflector".

The screenshot shows two panels. The top panel, titled 'Obs.condition', has a vertical toolbar on the left with icons for various observation conditions. The main area lists five conditions: 1.Angle/Tilt, 2.Dist, 3.Reflector (highlighted in yellow), 4.Atmos, and 5.Search/Track. The bottom panel, titled 'Reflector', has a similar toolbar and a table with columns 'Type', 'Const.', and 'Apert...'. Below the table are three green buttons labeled 'ADD', 'EDIT', and 'DEL'.

Type	Const.	Apert...
Prism	0	58
360°Prism	-7	34
Sheet	0	50
N-Prism		
Prism+	0	58

#### Factory setting

Factory settings are indicated in the above <Reflector>.

- "Prism+" indicates a target used with an external device or in a program installed in the Program mode.



#### prism constant correction value

Reflective prisms each have their prism constant.

Set the prism constant correction value of the reflective prism you are using. When selecting "N-Prism" in "Reflector", prism constant correction value is set to "0" automatically.

### PROCEDURE Editing target information

1. Select a target to edit in <Reflector> and press **[EDIT]**. Select/input relevant information for the target.

Items set and options

- (1) Reflector type  
Prism/Sheet/N-Prism/360° Prism
- (2) Prism Const.correction value  
-99 to 99 mm
- (3) Aperture  
1 to 999 mm

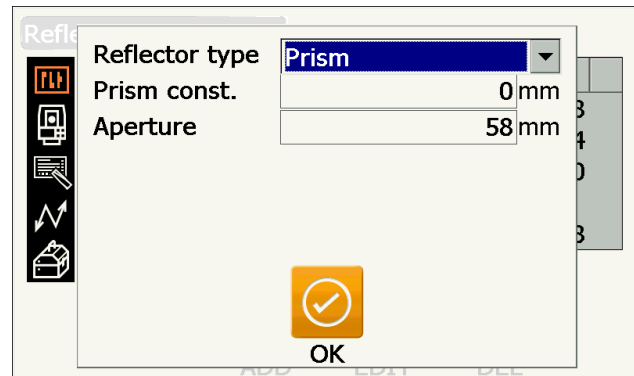

- When 0.1mm is selected in "Dist.reso", "Prism constant value" can be input to the first decimal place.

 "19.1 Observation Conditions - Angle/Tilt"

- **[DEL]**: Deletes the selected target.

2. Press **[OK]** to confirm the settings.

### PROCEDURE Adding a target

1. Press **[ADD]** in <Reflector> to display the list of candidate targets.

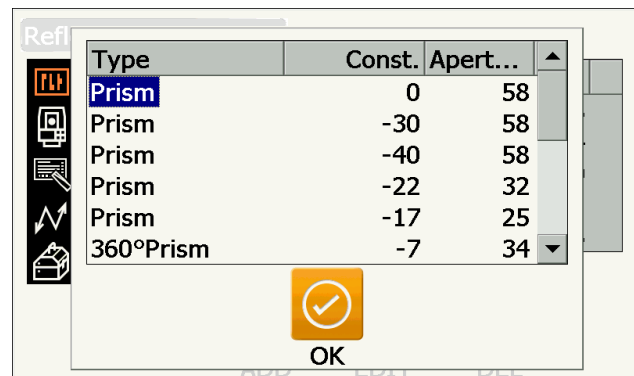

2. Select a frequently-used target from the list referring prism const.correction value and aperture.

- Up to a maximum of 6 targets can be registered.
- When selecting "N-Prism", prism constant correction value and aperture are not set.

3. Press **[OK]** to confirm the settings.

## 19.4 Observation Conditions - Atmosphere

Select "Obs.condition" in <Configuration> and select "Atmos".

The image shows two screenshots of a configuration interface. The top screenshot is titled "Obs.condition" and lists five options: 1.Angle/Tilt, 2.Dist, 3.Reflector, 4.Atmos (highlighted in yellow), and 5.Search/Track. The bottom screenshot is titled "Atmos" and shows the following settings: Temperature (15°C), Pressure (1013hPa), Humidity input (Yes), Humidity (50%), and ppm (0). A green button labeled "0 ppm" is located at the bottom of the "Atmos" screen.

### Items set and options (\*: Factory setting)

Temperature	: -35 to 60°C (15*)/-22 to +140°F (59*) (When Dist.reso. is 1 mm)
Pressure	: 500 to 1400hPa (1013*)/375 to 1050mmHg (760*)/14.8 to 41.3 (inchHg) (29.9*) (When Dist.reso. is 1 mm)
Humidity input	: No (50%)*/Yes
Humidity	: 0 to 100 (%) (50*) (When Dist.reso. is 1 mm)
ppm (Atmospheric correction factor) <input type="checkbox"/>	: -499 to 499 (0*) (When Dist.reso. is 1 mm)

- **[0ppm]**: Atmospheric correction factor returns to 0 and temperature and air pressure are set to the factory settings.
- Atmospheric correction factor is calculated and set using the entered values of the temperature and air pressure. Atmospheric correction factor can also be entered directly.
- The "Humidity" is displayed only when the "Humidity input" is set to "Yes".
- When 0.1 mm is selected in "Dist.reso", values can be input to the first decimal place.
- When the settings here are different between Basic mode and Program mode, Program mode settings are prior for use.



### Atmospheric correction factor

The velocity of the light beam used for measurement varies according atmospheric conditions such as temperature and air pressure. Set the atmospheric correction factor when you wish to take this influence into account when measuring.

- The instrument is designed so that the correction factor is 0 ppm at an air pressure of 1013.25 hPa, a temperature of 15°C, and a humidity of 50%.
- By inputting the temperature, air pressure values and humidity, the atmospheric correction value is calculated using the following formula and set into the memory.

$$\text{Atmospheric Correction Factor (ppm)} = 282.324 - \frac{0.294280 \times p}{1 + 0.003661 \times t} + \frac{0.04126 \times e}{1 + 0.003661 \times t}$$

t: Air temperature (°C)

p: Pressure (hPa)

e: Water vapor pressure (hPa)

h: Relative humidity (%)

E : Saturated water vapor pressure

- e (water vapor pressure) can be calculated using the following formula

$$e = h \times \frac{E}{100} \frac{(7.5 \times t)}{(t + 237.3)}$$

$$E = 6.11 \times 10^{(t + 237.3)}$$

- The instrument measures the distance with a beam of light, but the velocity of this light varies according to the index of refraction of light in the atmosphere. This index of refraction varies according to the temperature and pressure. Near normal temperature and pressure conditions:

With constant pressure, a temperature change of 1°C: an index change of 1 ppm.

With constant temperature, a pressure change of 3.6 hPa: an index change of 1 ppm.

To perform high accuracy measurements, it is necessary to find the atmospheric correction factor from even more accurate temperature and pressure measurements and perform an atmospheric correction. It is recommended that extremely precise instruments be used to monitor the air temperature and pressure.

- Enter the average temperature, air pressure and humidity along the measurement beam route in "Temperature", "Pressure" and "Humidity".

Flat terrain: Use the temperature, pressure and humidity at the midpoint of the line.

Mountainous terrain: Use the temperature, pressure and humidity at the intermediate point (C).

If it is not possible to measure the temperature, pressure and humidity at the midpoint, take such measurements at the instrument station (A) and the target station (B), then calculate the average value.

Average air temperature :  $(t_1 + t_2)/2$

Average air pressure :  $(p_1 + p_2)/2$

Average humidity :  $(h_1 + h_2)/2$

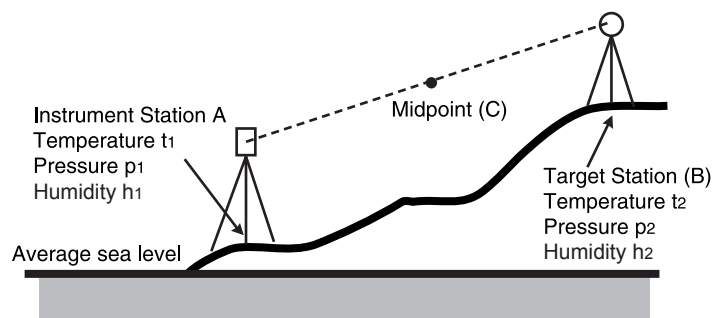

- If the weather correction is not required, set the ppm value to 0.

## 19.5 Instrument Conditions - Display

Select "Inst. Config" in <Configuration> and select "Display".

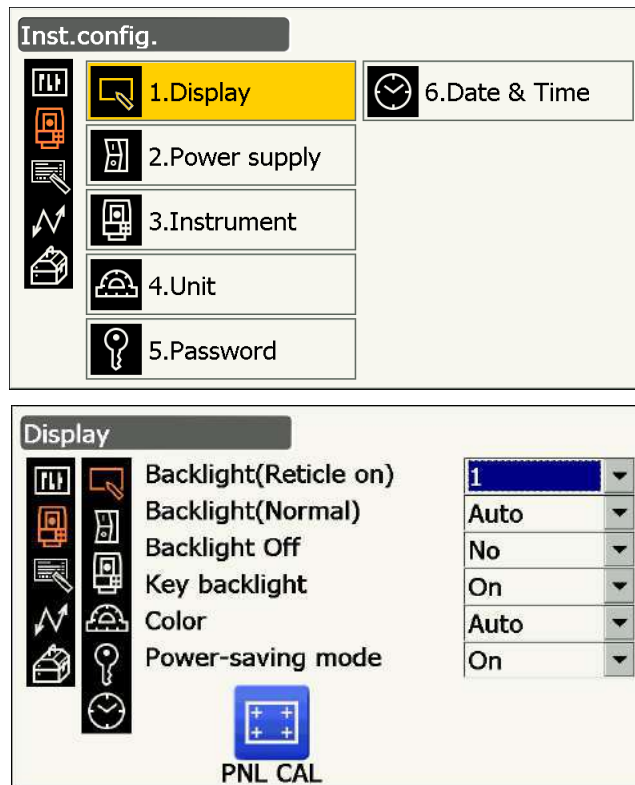

### Items set and options (\*: Factory setting)

Backlight (Reticle On)	: 0 to 8 (1*) (Brightness level on pressing {☼})
Backlight (Normal)	: 0 to 8/Auto (Auto*)
Backlight Off	: No*/30 sec/1 min./5 min./10 min.
Key backlight	: Off/On*
Color	: 1/2 (monochrome)/Auto (Auto*)
Power-saving mode	: Off/On*

- Press **[PNL CAL]** to display the touch panel calibration screen.  
 "8.1 Configuring the Touch Panel"
- "Power-saving mode" is displayed on the model with display on the both sides only.



### Adjusting backlight brightness/turning the reticle illumination and key backlight ON/OFF

Pressing  switches the brightness level of the backlight in conjunction with the ON/OFF status of the reticle illumination/key backlight.

When the instrument is powered ON the brightness level is set to "Backlight (Normal)". "Backlight (Normal)" was set to a higher brightness level than "Backlight (Reticle ON)" when the instrument was shipped but these values can be modified according to user preferences.

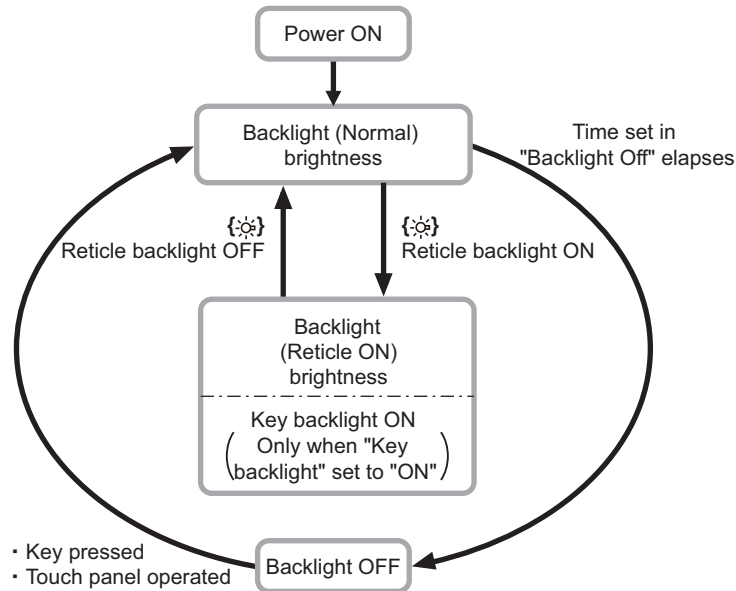

#### Note

- When "Backlight (Normal)" is set to "Auto" the instrument light sensor gauges the level of ambient brightness and automatically sets backlight brightness accordingly. Depending on ambient light conditions, performance of this function may be sub-optimal, or the display may flicker between brightness settings.

### Backlight Off

To save power, the backlight will be turned off if the instrument is not operated for the selected time. However, the backlight will not be turned off when "Backlight (Reticle)" is selected.

### Key backlight

The key backlight can be set to "ON" or "OFF". When "key backlight" is set to "ON", the key backlight is lit /OFF in conjunction with pressing .

### Color setting

Set "Color" to "2" (monochrome) when strong sunlight reduces visibility of the display. When "Auto" is selected, the instrument detects the ambient brightness level and automatically sets the appropriate color setting accordingly.

 "5.2 Display Functions"



- Do not block the instrument light sensor when "Color" is set to "Auto". The instrument will be unable to gauge ambient brightness and the display will flicker as a result.

### Power-saving mode



When "Power-saving mode" is set to "ON", the display unit which is not operated is switched the light off to save power.

## 19.6 Instrument Conditions - Power

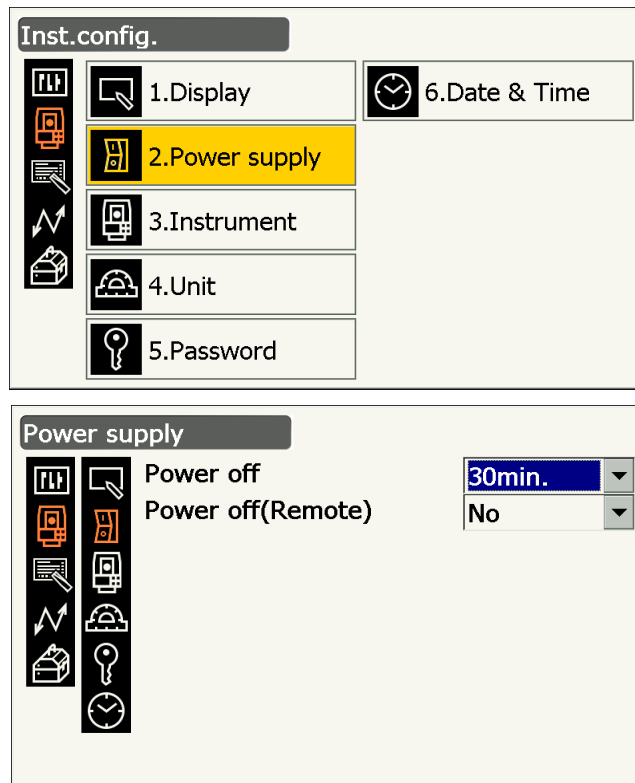
Select "Inst. Config" in <Configuration> and select "Power supply".



### Items set and options (\*: Factory setting)

Power off  : No/5 min./10 min./15 min./30 min.\*  
 Power off (Remote)  : No\*/5 min./10 min./15 min./30 min.

#### **Power off**

To save power, power to the instrument is automatically cut off if it is not operated for the set time.

#### **Power off (Remote)**

When turned on using a Power on command, power to the instrument is automatically cut off if it is not operated for the set time.

#### **Note**

- Command operations from a host computer can also be performed. For details, refer to "Communication manual" and ask your local dealer.

## 19.7 Instrument Conditions - Instrument

Select "Inst. Config" in <Configuration> and select "Instrument".

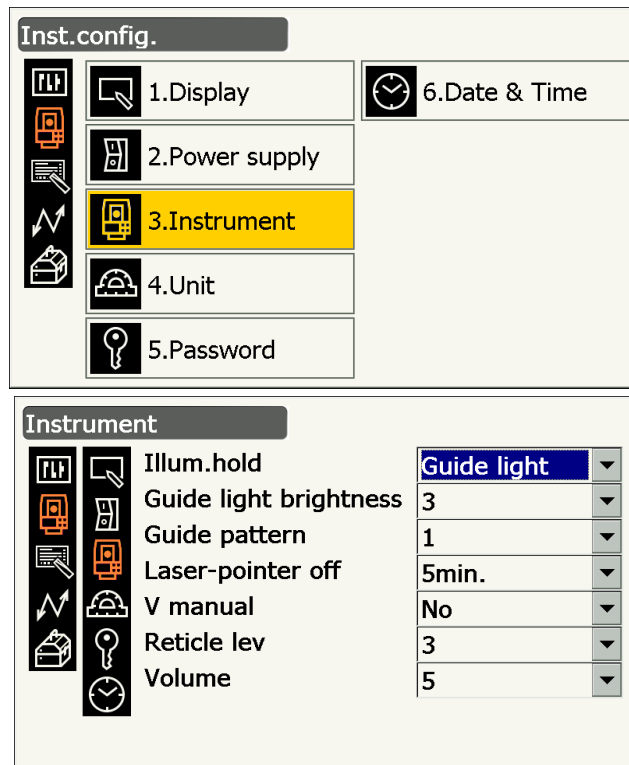

### Items set and options (\*: Factory setting)

Illum. hold (☀️) function	: Laser-pointer*/Guide light
Guide light brightness	: 1 to 3 (3*)
Guide pattern	: 1* (simultaneous)/2 (alternating)
Laser-pointer off	: No/1 min./5 min.* /10 min./30 min.
V manual	: No*/Yes
Reticle lev	: 0 to 5 level (3*)
Volume	: Off/1/2/3/4/5 (3*)

- "Reticle lev"

"19.5 Instrument Conditions - Display Adjusting backlight brightness/turning the reticle illumination and key backlight ON/OFF"

- Setting "V manual" to "Yes"

"27.2 Manually Indexing the Vertical Circle by Face 1/2 Measurement"

### Laser-pointer off

To save power, the laser-pointer is automatically turned off after the set time has elapsed.

## 19.8 Instrument Conditions - Unit

Select "Inst. Config" in <Configuration> and select "Unit".

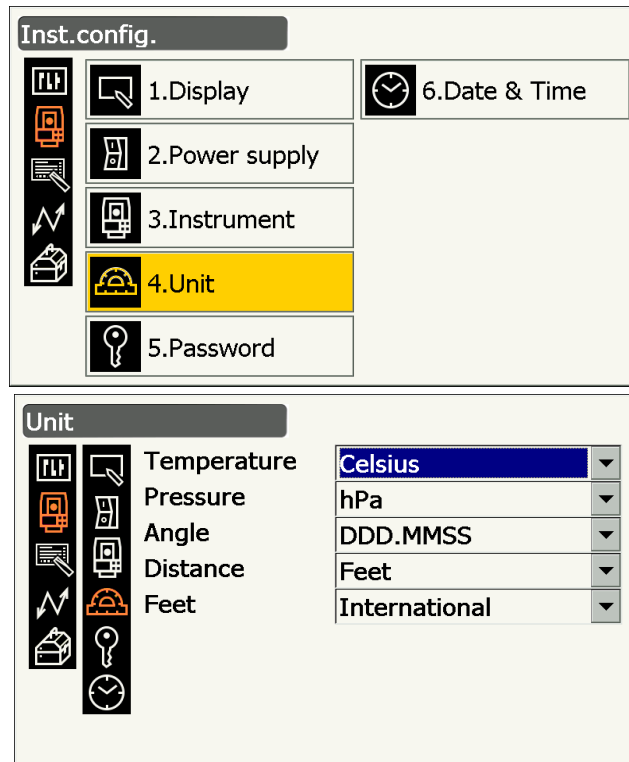

### Items set and options (\*: Factory setting)

Temperature	: Celsius*/Fahrenheit
Pressure	: hPa*/mmHg/InchHg
Angle	: Degree (DDD.MMSS)*/Gon/Mil
Distance	: Meter*/Feet/Inch
Feet	: International*/US

- "Feet" is displayed only when "Distance" is set to "Feet" or "Inch".



### Inch (Fraction of an inch)

"Fraction of an inch" is the unit used in the United States and expressed like the following example.

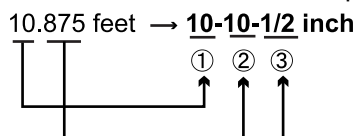

- ① 10.000 feet
- ② 0.875 feet x 12=10.5 inch
- ③ 0.5 inch=1/2 inch



- Even if "inch" is selected in this setting, all the data including the result of area calculation are output in "feet" and all the distance values must be input in "feet". In addition, when the "inch" display exceeds the range, it is displayed in "feet".

## 19.9 Instrument Conditions - Password

When a password has been set, the password screen will appear when the instrument is powered ON.

Setting a password allows you to protect important information such as measurement data.

No password was set when the instrument was shipped. When setting a password for the first time, leave the "Old password" box blank.

Select "Inst. Config" in <Configuration> and select "Password".

The image shows two screenshots of the instrument's configuration interface. The top screenshot, titled "Inst. config.", displays a list of configuration options: 1. Display, 2. Power supply, 3. Instrument, 4. Unit, 5. Password (highlighted in yellow), and 6. Date & Time. The bottom screenshot, titled "Password", shows three input fields: "Old password", "New password", and "New password again". An "OK" button with a checkmark icon is located at the bottom right of the "Password" screen.

### Items set

Old password : Input current password  
 New password : Input the new password  
 New password again : Input the new password again

- Password can be from 3 up to 16 characters in length. Input characters will be displayed as asterisks.
- To deactivate the password function, perform the new password setting procedure but enter a "space" in the "New password" box.



- The password function will not be canceled when a cold boot is performed.
- The password must be input after powering ON the instrument from an external device when a password has been set.

## 19.10 Instrument Conditions - Date and Time

Select "Inst. Config" in <Configuration> and select "Date & Time".

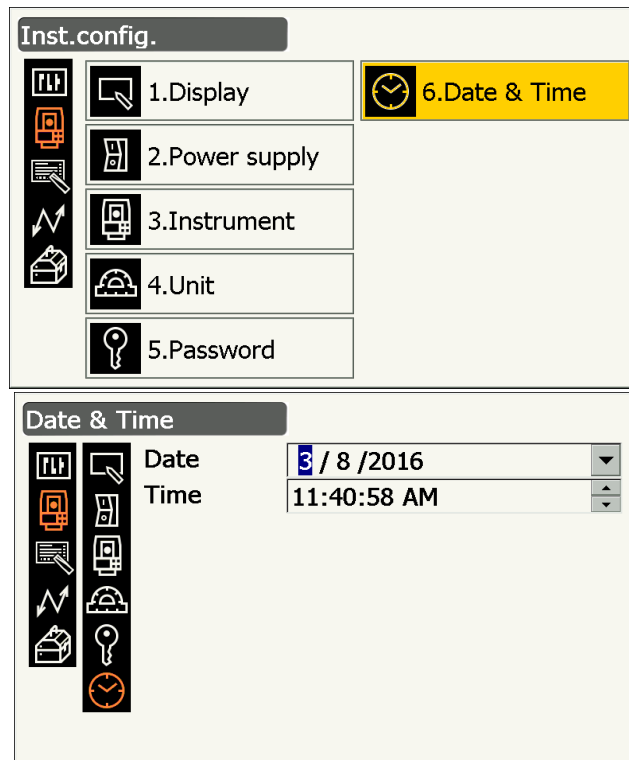

### Items set

- Date : Manually input date or select from the drop-down calendar by tapping ▼.
- Time : Manually input time or set using [▲]/[▼].  
Pressing {S.P.} will increment the selected section by 1.



### Date and Time

The instrument includes a clock/calendar function.

## 19.11 Customizing Screen Controls

It is possible to customize screen controls in Observation mode to suit the measurement conditions and the different methods employed by different operators.

- The current screen control settings are retained until they are revised again, even when the power is cut off.
- Press **[CLEAR]** in <Customize/Select screen> "19.11 Customizing Screen Controls" " PROCEDURE Customizing screen controls" step 2 to return all customized configurations including status icon settings and Operating icon allocations to their previous settings.
- Screen controls cannot be set for the "Graphic" display.



- When screen control settings are recorded and registered, the previously recorded settings are cleared.

The following items are explained in other sections.

Changing Allocation of Operation icons: "19.12 Allocating Operating Icons"

Changing Allocation of Starkey mode: "19.13 Changing Starkey Mode Icons"

## PROCEDURE Customizing screen controls

1. Select "Customize" to display <Customize/Select screen>.

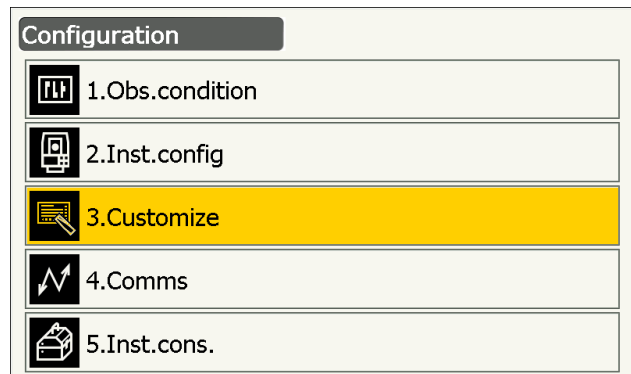

2. Select the measurement mode in which you want to customize screen controls.



3. Select "Control".

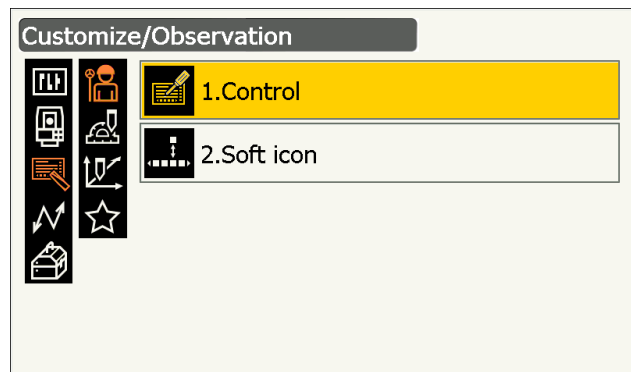

4. Press **[ADD]** to add a control drop-down list.

- Press **[DEL]** to delete the selected control.



5. Select a screen control from the list.

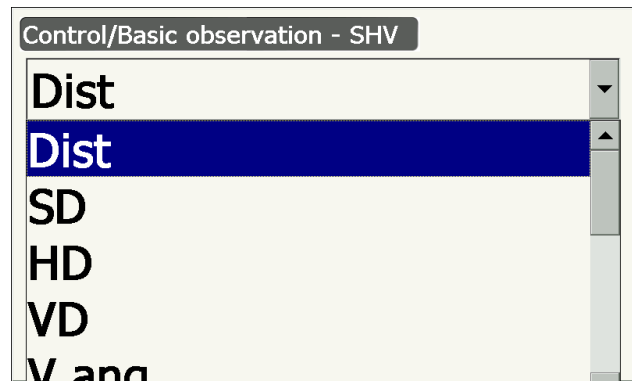

6. Press **[CNFG]** to set the size, thickness, color and spacing of the font.

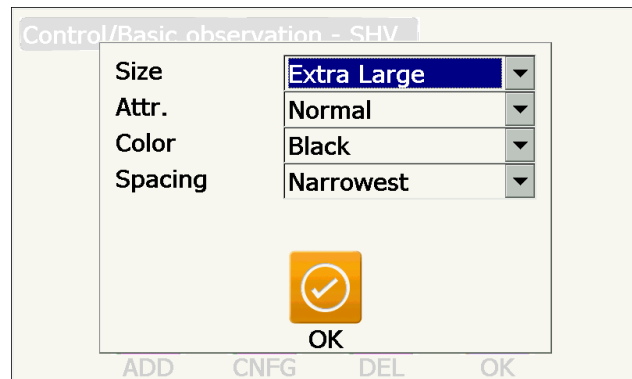

7. Repeat steps 4 to 6 to customize more screen controls.

8. Press **{ESC}** to finish customizing screen controls. The modifications are stored in memory and previous screen is displayed. The modifications are reflected in the relevant screens.



## 19.12 Allocating Operating Icons

It is possible to allocate the Operating icons in Observation mode to suit the measurement conditions. It is possible to operate the instrument efficiently because unique Operating icon allocations can be preset to suit various applications and the ways that different operators handle the instrument.

- The current Operating icon allocations are retained until they are revised again, even when the instrument is powered OFF.
- Press **[CLEAR]** in <Customize/Select screen> in "19.12 Allocating Operating Icons" "PROCEDURE Allocating a Operating icon" step 2 to return all customized configurations including Status icon/starkey mode settings, and screen controls to their previous settings.



- When Operating icon allocations are recorded and registered, the previously recorded key settings are cleared.
- Operating icons cannot be allocated to "Graphic" displays.

### ● Screens that can be customized and Operating icon allocations when shipped

1. "SHV" and "SHVdist" displays of <Basic observation>

**[TRK On] [MOTOR] [0SET] [MEAS]  
[SRCH] [EDM] [H-SET] [COORD]  
[OFFSET] [RESEC] [REM] [S-O]**

2. "Obs." display of <Setting out>

**[TRK On] [SHVR] [H.TURN] [MEAS]  
[CNFG] [ --- ] [ --- ] [REM]  
[ --- ] [ --- ] [ --- ] [ --- ]**

3. "SHV" and "NEZ" displays of <Set out Coords>

**[OK] [TRK On][H.TURN] [MEAS]  
[CNFG] [ --- ] [ --- ] [ --- ]  
[ --- ] [ --- ] [ --- ] [ --- ]**

### ● Functions that can be allocated to the Operating icons

<b>[ --- ]</b>	: No functions set
<b>[MEAS]</b>	: Distance and angle measurement
<b>[0SET]</b>	: Set horizontal angle to 0°
<b>[H-SET]</b>	: Set required horizontal angle
<b>[SHV]</b>	: Switch the "SHV" display and "SHVdist" display (can only be allocated to 1 above)
<b>[L/R]</b>	: Select horizontal angle left/right. The capitalized letter in the Operating icon indicates the currently selected mode.
<b>[ZA / %]</b>	: Switch between zenith angle/slope in %. The capitalized letter in the Operating icon indicates the currently selected mode.
<b>[HOLD]</b>	: Hold horizontal angle/release horizontal angle
<b>[CALL]</b>	: Display final measurement data
<b>[HVOU-T-S]</b>	: Output angle measurement results to an external device (SET format)
<b>[HVDOUT-S]</b>	: Output distance and angle measurement results to an external device (SET format)
<b>[NEZOUT-S]</b>	: Output coordinates data to an external device (SET format)
<b>[HVOU-T]</b>	: Output angle measurement results to an external device (GTS format) (can only be allocated to 1 above)
<b>[HVDOUT-T]</b>	: Output distance and angle measurement results to an external device (GTS format) (can only be allocated to 1 above)
<b>[NEZOUT-T]</b>	: Output coordinates data to an external device (GTS format) (can only be allocated to 1 above)
<b>[F/M]</b>	: Switch distance units between meters/feet
<b>[HT]</b>	: Set the instrument station, coordinates and instrument height

<b>[S-LEV]</b>	: Return signal
<b>[TILT]</b>	: Display tilt angle
<b>[MOTOR]</b>	: Display <Search/Track>
<b>[INV]</b>	: Rotates the instrument 180°
<b>[SRCH]</b>	: Automatically sights the center of the target
<b>[RC]</b>	: Rotate in the direction specified by the Remote Control System (Auto Tracking model only)
<b>[&lt;-RC]</b>	: Rotate in a counterclockwise direction (from the point of view of the Remote Controller) (Auto Tracking model only)
<b>[RC-&gt;]</b>	: Rotate in a clockwise direction (from the point of view of the Remote Controller) (Auto Tracking model only)
<b>[RC Cont]</b>	: Nullify the current measurement position and continue Turning operation (Auto Tracking model only)
<b>[TRK On]</b>	: Start Auto Tracking (Auto Tracking model only. <b>[TRK Off]</b> during Auto Tracking)
<b>[EDM]</b>	: Distance measurement setting
<b>[ATMOS]</b>	: Atmosphere setting
<b>[MENU]</b>	: Display <Menu> (coordinate measurement, setting out measurement, offset measurement, REM measurement, missing line measurement, resection, area calculation)
<b>[COORD]</b>	: Coordinates measurement
<b>[S-O]</b>	: Setting-out measurement
<b>[OFFSET]</b>	: Offset measurement
<b>[A-OFS]</b>	: Angle offset menu
<b>[D-OFS]</b>	: Distance offset menu
<b>[2D-OFS]</b>	: Offset/2D menu
<b>[MLM]</b>	: Missing line measurement
<b>[REM]</b>	: REM measurement
<b>[RESEC]</b>	: Resection measurement
<b>[AREA]</b>	: Surface area measurement
<b>[CNFG]</b>	: Set setting out accuracy (can only be allocated to 2 and 3 above)
<b>[H.TURN]</b>	: Rotate the instrument to the entered horizontal angle. Rotate horizontally to the angle for the setting out point when performing setting out (can only be allocated to 2 and 3 above).
<b>[SHVR]</b>	: Switch distance mode between slope distance (SD)/horizontal distance (HD)/height difference (VD)/REM (R) in setting out screens. The capitalized letter in the Operating icon indicates the currently selected mode (can only be allocated to 2 above).
<b>[OK]</b>	: Terminate setting out measurement for the selected setting out point and return to <Key in coord>. This setting out point will be removed from the list (can only be allocated to 3 above).

### PROCEDURE Allocating a Operating icon

1. Select "Customize" to display <Customize/Select screen>.

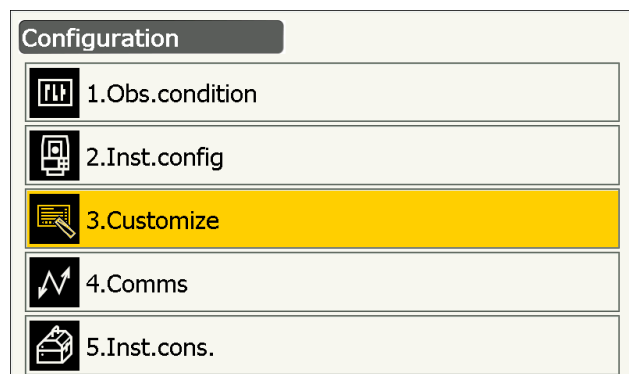

2. Select the measurement mode in which you want to customize Operating icons.

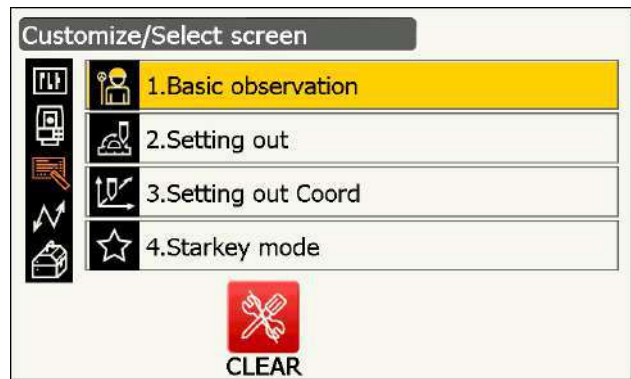

3. Select "Operating icon".

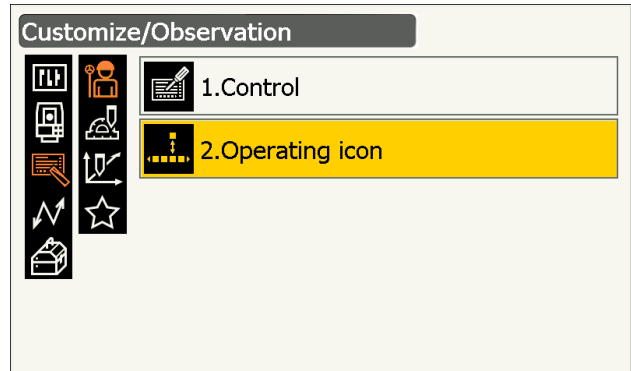

4. Select an Operating icon whose allocation you want to change.



Tap the Operating icon to display the Operating icon list.

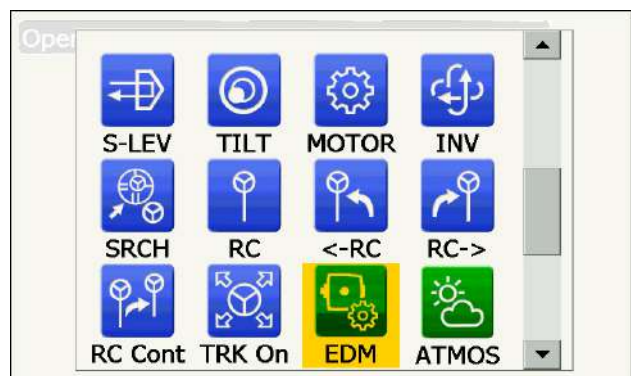

5. Select the desired Operating icon from the Operating icon list to allocate to the position specified in step 4.
6. Repeat steps 4 to 5 to perform further key allocations.

- Press **{ESC}** to finish allocating icons. The allocated icons are stored in memory and the previous screen is restored. The newly allocated icons appear in the relevant measurement screen.

### 19.13 Changing Starkey Mode Icons

It is possible to preset icon allocations of the Starkey mode to suit various applications and the ways that different operators handle the instrument.

- The current icon allocations are retained until they are revised again, even when the power is turned off.
- Press **[CLEAR]** in <Customize/Select screen> in "19.13 Changing Starkey Mode Icons" "PROCEDURE Changing Starkey icon allocations" step 2 to return all customized configurations including screen controls and Operating icon allocations to their previous settings.



- When icon allocations are recorded and registered, the previously recorded settings are cleared.
- When the upper 8 icons' allocations are recorded and registered, the setting reflects to Status icon.

#### ● Icons that can be allocated to the Status icon

Remaining battery power  
 Target display  
 Motor  
 Laser-pointer/guide light  
 Tilt angle compensation  
 Communication status  
 Input mode  
 SIP (Input panel)  
 ppm (atmospheric correction factor)  
 Internet communication status  
 Touch panel  
 Disk  
 No icon

#### PROCEDURE Changing Starkey icon allocations

- Select "Customize" to display <Customize/Select screen>.

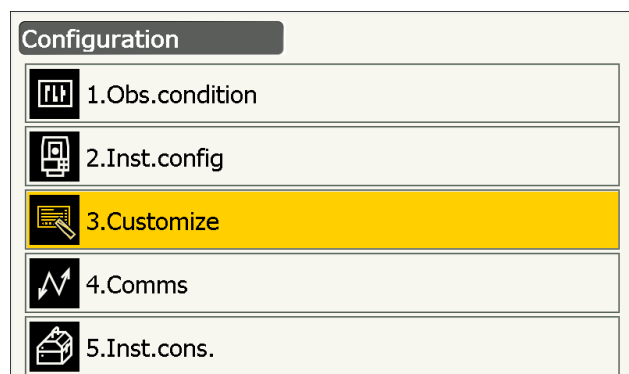

2. Select "Starkey mode".

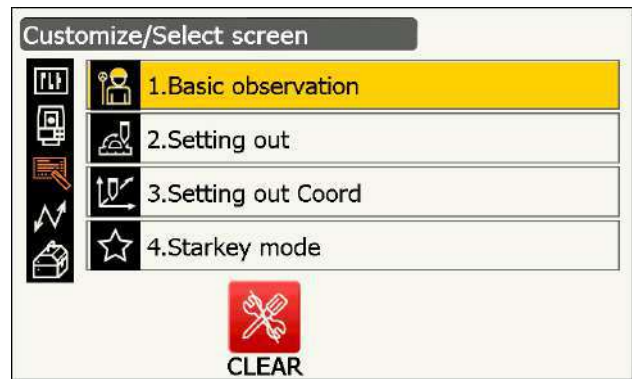

3. Select a Starkey mode icon you wish to re-allocate.



Tap the icon to display the Starkey mode icon list.



4. Select the new icon from the Starkey mode icon list.  
The icon is allocated in the selected icon position.

5. Repeat steps 3 to 4 to perform further icon allocations.

6. Press **{ESC}** to finish allocating icons. The allocated icons are stored in memory and the previous screen is restored. The newly allocated icons appear in the relevant measurement screen.

## 19.14 Restoring Default Settings



Perform a cold boot to return all items to factory settings. A cold boot will not erase surveying data in instrument. However, if the data in the memory is important, BE SURE TO TRANSFER IT TO A PERSONAL COMPUTER BEFORE PERFORMING A COLD BOOT.



- The password function will not be canceled.
- Resume function will be canceled.

### PROCEDURE

---

1. "To perform a cold boot, while holding {} and {S.P.}, press the power key on the side of the instrument. "All Settings will be cleared. Are you sure?" is displayed.
2. Press [YES] to continue.
  - Select [NO] and press {Enter}, or press {ESC} to cancel.
3. When the power is ON after the a cold boot, the screen for configuring the touch panel is displayed. Configure the touch panel to continue.  
 "8.1 Configuring the Touch Panel"

# 20.WARNING AND ERROR MESSAGES

The following is a list of the error messages displayed by the instrument and the meaning of each message. If the same error message is repeated or if any message not shown below appears, the instrument has malfunctioned. Contact your local dealer.

## **Backup battery dead. Clock display may no longer be correct.**

The voltage supplied by the lithium battery either declines or is completely discharged.  
Ask your local dealer to replace the battery for you.

## **Bad condition**

The air is shimmering a lot, etc., measuring conditions are poor.

The center of the target cannot be sighted.  
Resight the target.

Unsuitable distance measurement conditions when reflectorless measurement is set. When reflectorless measurement is set, distance cannot be measured because the laser beam is striking at least two surfaces at the same time.

Choose a single surface target for distance measurement.

 Precautions for setting prism: "10. TARGET SIGHTING AND MEASUREMENT"

## **Calculation error**

Coordinates identical to the known point coordinates observed during resection exist. Set another known point so that the known point coordinates do not coincide.

During surface area calculation, conditions necessary for calculations are not met. Check conditions and try again.

An error occurred during calculation.

## **Checking Device... Please wait several minutes to start the connected.**

Cellular communication is not ready.

After powering ON, it is necessary to wait about 5 minutes until cellular communication is ready. Wait about 5 minutes and then perform a connection.

## **Error: Instrument info.**

### **Error: Self check**

Press **[OK]** to cancel the message. If this error message appears frequently, contact your local dealer.

## **Failed Change Carrier!**

During cellular communication, carrier cannot be changed as desired.  
Check the settings and try again.

## **Failed Device Power On/Off! (218)**

Inside Device Power cannot be turned ON/OFF.  
Try again.

## **Incorrect password.**

Input password does not match set password.  
Input correct password.

## **Input over 3 letters!**

The input password consists of less than 3 characters. Input a password at least 3 characters in length.

**Motor error EXXX**

A problem has occurred with the motor drive and operation stops.  
Power the instrument OFF then ON to correct the problem.  
If this error message appears frequently, contact your local dealer.

**Need base pt. obs**

During REM measurement, the observation of the target was not completed normally.  
Reset and sight the prism and perform measurement again.

**New password Diff.**

During new password setting, the passwords input twice are different.  
Input new password twice correctly.

**No solution**

The calculation of the instrument station coordinates during resection does not converge.  
Access the results and if necessary, perform the observations again.

**Out of range**

During gradient % display, the display range (less than  $\pm 1000\%$ ) has been exceeded.  
During REM measurement, either the vertical angle has exceeded horizontal  $\pm 89^\circ$  or the measured distance is greater than 9999.999m.  
Install the instrument station far from the target.

**Reflectorless not supported!!**

Auto Tracking cannot be performed in reflectorless mode.  
Use the prism to carry out automatic sighting.

**Remote Control communication err!!**

Communication between the Remote controller for Remote Control System and the instrument failed.  
Check the status (communications setup, power supply, cable connections etc.) of the Remote controller, wireless modem and cables.

**Sheet not supported!!**

Auto Tracking cannot be performed with the sheet.  
Use the prism to carry out automatic sighting.

**Signal off**

The reflected light is not observed when distance measurement begins. Or, during measurement, the reflected light has weakened or is blocked.  
Either sight the target again or, when using a reflective prism, increase the number of reflective prisms.

**SIM card Error!**

SIM card is not inserted or not inserted correctly.  
Check if the SIM card is inserted correctly.

**Start Up Error: Step XX**

Press [OK] to close the message. If the same error message is repeated, contact your local dealer.

**Take BS reading**

The origin measurement is not finished normally in missing line measurement. Collimate the origin accurately and measure it again.



**Target not found!!**

The prism cannot be found within the Search area range.  
Reset and sight the prism and perform measurement again.

**TelCtrl Error: E812 (XXX)**

If the same error message is repeated, contact your local dealer.

**Temp Rnge OUT**

The instrument is outside useable temperature range and accurate measurement cannot be performed.  
Repeat measurement within the appropriate temperature range.

**The internal processing was started. The cellular communication was stopped.**

Cellular communication cannot be performed because the internal communication processing started.  
Wait for a while and then perform a connection.

**Tilt over range!!**

The tilt angle exceeds the tilt angle compensation range of the sensor.  
Level the instrument again.

**Time out!!**

Measurement is not carried out in the allotted time.  
Reset and sight the prism and perform measurement again.

When designating the angle of rotation or automatically sighting the prism, there is a problem with the positioning of the prism or the operation of the instrument and measurement is not obtained within the fixed time.

Check the positioning of the instrument and prism and perform measurement again.  
If observation is still not possible, sight the target manually.

**When the telescope turns to nadir, it is not possible to search!!**

The instrument cannot perform a search during Auto Pointing when the telescope is directed to the nadir angle.  
Set the telescope position within the measuring range and perform measurement again.

# 21.CHECKS AND ADJUSTMENTS

iX is a precision instrument that requires fine adjustments. It must be inspected and adjusted before use so that it always performs accurate measurements.

- In addition, the instrument should be inspected with special care after it has been stored a long time, transported, or when it may have been damaged by a strong shock.
- Make sure the instrument is securely set up and stable before performing checks and adjustments.

## 21.1 Circular Level

The bubble tube is made of glass, so it is sensitive to temperature changes or to shock. Check and adjust it as outlined below.



- Be careful that the tightening tension is identical for all the adjusting screws. Also, do not over-tighten the adjusting screws as this may damage the circular level.

### PROCEDURE Checking and adjusting

1. Level while checking <Tilt>.

☞ "7.2 Levelling" Step 3 to 4



- Tap Tilt angle compensation icon  in the Status icon or in Starkey mode to display electric circular level.



- If the tilt sensor is misaligned, the circular level is not adjusted correctly.

☞ "21.2 Tilt Sensor"

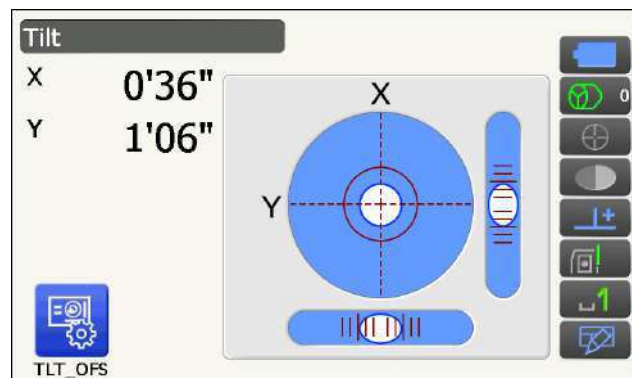

2. Check the position of the bubble of the circular level.

If the bubble is not off-center, no adjustment is necessary.

If the bubble is off-center, perform the following adjustment.

3. First confirm the off-center direction.  
Use the adjusting pin to loosen the circular level adjustment screw on the side opposite to the direction the bubble is displaced to move the bubble to the center.

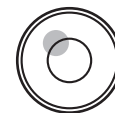

Circular level  
adjusting screws

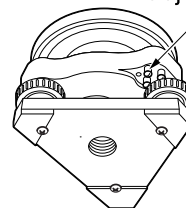

4. Adjust the adjusting screws until the tightening tension of the three screws is the same to align the bubble in the middle of the circle.

## 21.2 Tilt Sensor

If the tilt angle shown on the display shifts from tilt angle  $0^\circ$  (zero point), the instrument is not correctly levelled. This will adversely affect angle measurement.

Perform the following procedures to cancel the tilt zero point error.

### PROCEDURE Checking and adjusting

1. Carefully level the instrument. If necessary, repeat the procedures to check and adjust the bubble levels.

2. Select "Inst. cons." in <Configuration>

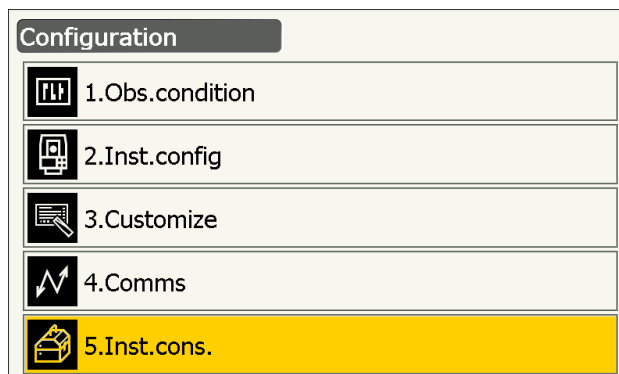

3. Select "Tilt offset".

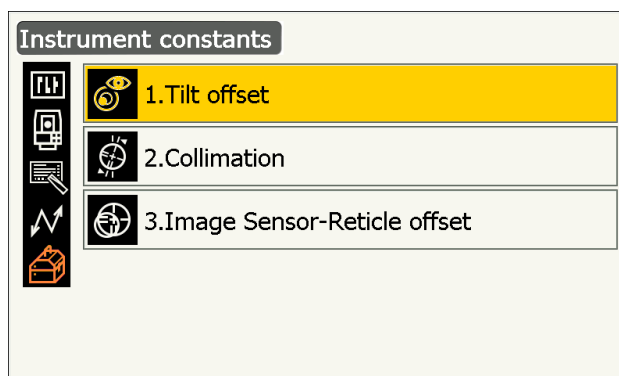

4. Level the instrument again until the X/Y tilt angles are  $\pm 1'$ . Wait a few seconds for the display to sdisplayilize.



5. Press **[OK]**. The top of the instrument and telescope rotate  $180^\circ$  from the current position. Wait a few seconds for the screen to sdisplayilize.

- Press **[OK]** to automatically rotate the top of the instrument and telescope through 180°.



- Newly measured tilt correction constant is displayed.  
 Compare current "Tilt X" and new "Tilt X".  
 Compare the constants of "Tilt Y" as well.  
 If each difference is within the range of  $\pm 1'$ , press **[YES]** to renew the correction angle. <Instrument constants> is restored.  
 If the values exceed the above range, press **[NO]** to cancel the adjustment and contact your local dealer to perform the adjustment.  
 When entering this screen only for checking constants, press **[NO]** to return to <Instrument constants>.

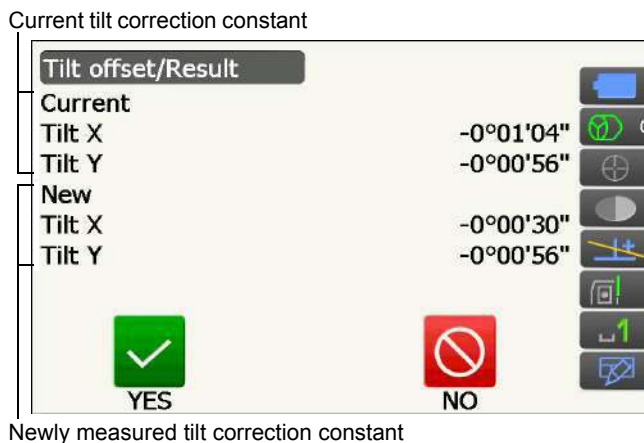

### 21.3 Reticle

With this option you can check the perpendicularity of the reticle and the horizontal/vertical positions of reticle lines.



- Check the telescope reticle by sighting the target.

#### PROCEDURE Check 1: Perpendicularity of the reticle to the horizontal axis

- Carefully level the instrument.
- Align a clearly visible target (the edge of a roof for example) on point A of the reticle line.

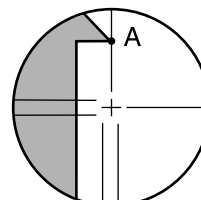

- Use the fine motion screws to align the target to point B on a vertical line.  
 If the target moves parallel to the vertical line, adjustment is unnecessary. If its movement deviates from the vertical line, have our service representative adjust it.

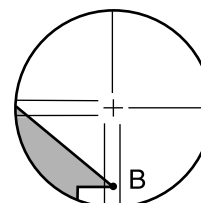

**PROCEDURE Check 2: Vertical and horizontal reticle line positions**

- Perform check in weak sunlight and no scintillation.
- "Tilt crn" should be set to "Yes (H,V)" and "Coll.crn" to "Yes" in <Obs. condition> while performing checks.

"19.1 Observation Conditions - Angle/Tilt"

1. Carefully level the instrument.
2. Install a target at a point about 100 m in the horizontal direction from the instrument.



3. While the Observation mode screen is displayed and the telescope is in Face 1, sight the center of the target correctly and read out the horizontal angle A1 and the vertical angle B1.

Example:

Horizontal angle A1 = 18° 34' 00"

Vertical angle B1 = 90° 30' 20"

4. While the telescope is in Face 2, sight the center of the target correctly and read out the horizontal angle A2 and the vertical angle B2.

Example:

Horizontal angle A2 = 198° 34' 20"

Vertical angle B2 = 269° 30' 00"

5. Do the calculations: A2-A1 and B2+B1

If A2-A1 is within 180°±20" and B2+B1 is within 360°±20", adjustment is unnecessary.

Example:

A2-A1 (Horizontal angle)
= 198° 34' 20" - 18° 34' 00"
= 180° 00' 20"
B2+B1 (Vertical angle)
= 269° 30' 00" + 90° 30' 20"
= 360° 00' 20"

If the difference is large even after repeating the check 2 or 3 times, make sure that checking and adjusting of "21.2 Tilt Sensor" and "21.4 Collimation" are completed.

If the results remain the same, have our service representative perform the adjustment.

## 21.4 Collimation

If for whatever reason instrument error relating angle measurement occurs, this will adversely affect angle measurement. With this option you can measure collimation offset constant in your instrument so that the instrument can eliminate the angle error between Face 1 and 2. Perform the following procedures to correct the collimation offset constant.



- Perform adjustment in weak sunlight and no scintillation.



- It is recommended to perform collimation adjusting before the measurement especially when accurate result is desired in single face observations.

### PROCEDURE Adjusting

1. Carefully level the instrument.
2. Install a target at a point about 100 m in the horizontal direction from the instrument.
3. Select "Inst. cons." in <Configuration>.



4. Select "Collimation".

Configuration

	1.Obs.condition
	2.Inst.config
	3.Customize
	4.Comms
	5.Inst.cons.

Instrument constants

	1.Tilt offset
	2.Collimation
	3.Image Sensor-Reticle offset

5. While the telescope is in Face 1, sight the center of the target correctly and press **[OK]**. Telescope rotates and vertical circle is indexed.



- Do not look through the telescope eyepiece while the motor drive is in operation. An eye could be struck by the telescope and cause injury.

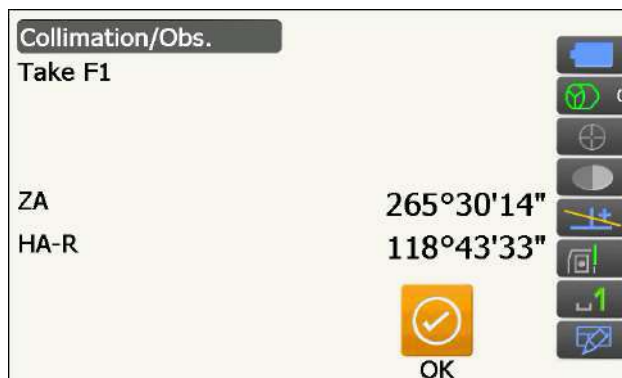

6. While the telescope is in Face 2, sight the center of the target correctly and press **[OK]**.



7. Press **[YES]** to set the constant.

- Press **[NO]** to discard the data and return to the screen in step 4.



## 21.5 Image Sensor Reticle

The internal image sensor is used for automatic sighting. The offset value is set to correct the position of the image sensor in relation to the telescope reticle, but if for whatever reason the telescope reticle and image sensor become misaligned, automatic sighting of the center of the prism cannot be performed correctly and this will adversely affect angle measurement. Check and adjust it as outlined below.



- Perform check and adjustment in weak sunlight and no scintillation.
- It may take up to 20 seconds for an offset value based on the measurement results to appear.
- Use Standard prism AP01AR or Compact prism CP01. Using other prism types may result in adjustment inaccuracies.



- It is recommended to adjust image sensor reticle before the measurement especially when accurate result is desired in single face observations by Auto Pointing/Auto Tracking.

**PROCEDURE Checks and adjustments**

- Carefully level the instrument.
- Position the prism in a horizontal direction approximately 50 meters from the instrument.



- Select "Inst.cons." in <Settings>.

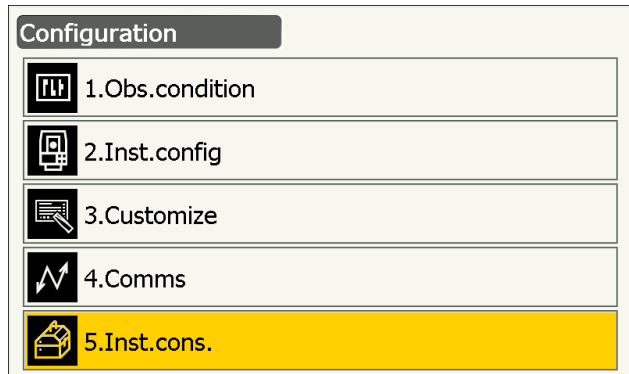

- Select "Image Sensor-Reticle offset".

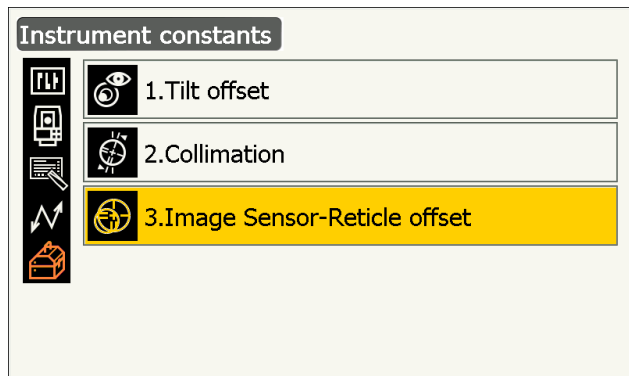

- Use manual sighting to accurately sight the target.  
 ☞ "10.3 Manually Sighting the Target"



- Sight not the center of the target plate but the center of the prism.

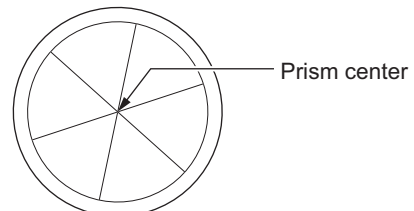

- Press **[OK]**.

- Press **[STOP]** to stop the measurement.



7. Offset value (H, V) (New) is obtained from the set offset value (H, V) (Current) and the measurement results. The offset value is a constant value that indicates the number of degrees of misalignment between the center of the telescope reticle and the center of the image sensor. If the offset value obtained from the measurement result is significantly larger than the set offset value, press **{ESC}** and resight the target.

If the offset value (H, V) obtained from the measurement results continues to be significantly large after repeated checks, adjustment is necessary. Go to step 8.

If one of the offset values exceeds the range, an error message appears on the screen. Contact your local dealer to perform the adjustment.

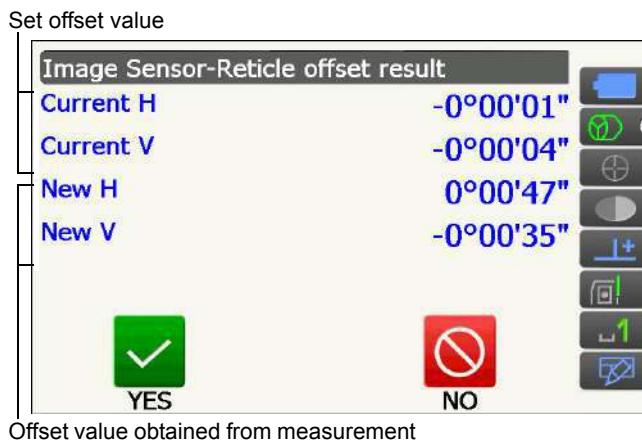

8. Press **[OK]** to renew the offset value.

## PROCEDURE Rechecking



- Sight the prism using the Auto Pointing function during a recheck.
- "Tilt crn" should be set to "Yes (H,V)" and "Coll.crn" to "Yes" in <Obs. condition> while performing checks.  
 "19.1 Observation Conditions - Angle/Tilt"

1. Carefully level the instrument.
2. Install a prism at a point about 50 m in the horizontal direction from the instrument.
3. While the Observation mode screen is displayed and the telescope is in Face 1, sight the center of the prism correctly and read out the horizontal angle A1 and the vertical angle B1.  
 Example:  
 Horizontal angle A1 = 18° 34' 00"  
 Vertical angle B1 = 90° 30' 20"



4. While the telescope is in Face 2, sight the center of the prism correctly and read out the horizontal angle A2 and the vertical angle B2.  
 Example:  
 Horizontal angle A2 = 198° 34' 20"  
 Vertical angle B2 = 269° 30' 00"

5. Do the calculations:  $A_2 - A_1$  and  $B_2 + B_1$   
 If  $A_2 - A_1$  is within  $180^\circ \pm 20''$  and  $B_2 + B_1$  is within  $360^\circ \pm 20''$ , adjustment is unnecessary.

Example:  $A_2 - A_1$  (Horizontal angle)  
 $= 198^\circ 34' 20'' - 18^\circ 34' 00''$   
 $= 180^\circ 00' 20''$

$B_2 + B_1$  (Vertical angle)  
 $= 269^\circ 30' 00'' + 90^\circ 30' 20''$   
 $= 360^\circ 00' 20''$

If the difference is large even after repeating the check 2 or 3 times, make sure that checking and adjusting of "21.2 Tilt Sensor" and "21.4 Collimation" are completed.

If the results remain the same, have our service representative perform the adjustment.

## 21.6 Optical Plummet



- Be careful that the tightening tension is identical for all the adjusting screws.
- Also, do not over-tighten the adjusting screws as this may damage the circular level.

### PROCEDURE Checking

1. Carefully level the instrument and center a survey point precisely in the reticle of the optical plummet.
2. Turn the upper part through  $180^\circ$  and check the position of the surveying point in the reticle.  
 If the surveying point is still centered, no adjustment is necessary.  
 If the surveying point is no longer centered in the optical plummet, perform the following adjustment.

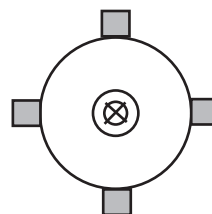

### PROCEDURE Adjusting

3. Correct half the deviation with the levelling foot screw.

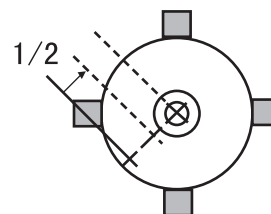

4. Remove the optical plummet reticle cover.

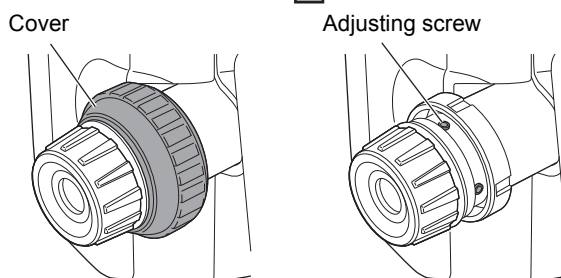

5. Use the 4 adjusting screws of the optical plummet to adjust the remaining half of the deviation as shown below.

When the survey point is on the lower (upper) part of the illustration:

Loosen the upper (lower) adjusting screw slightly, and tighten the upper (lower) adjusting screw the same amount to move the survey point to a point directly under the center of the optical plummet. (It will move to the line in the figure on the right.)

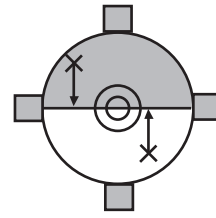

If the survey point is on the solid line (dotted line):

Loosen the right (left) adjusting screw slightly and, tighten the left (right) adjusting screw by the same amount to move the survey point to a point in the center of the optical plummet.

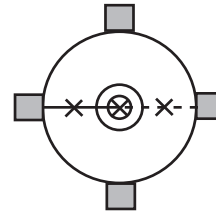

6. Check to make sure that the survey point remains centered on the reticle even if the upper part of the instrument is rotated.

If necessary, perform the adjustment again.

7. Replace the optical plummet reticle cover by matching the grooves on the cover with the grooves on the optical plummet.

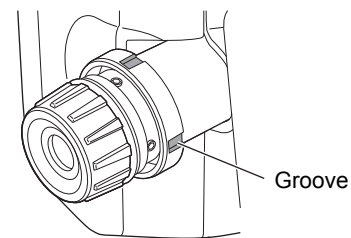

## 21.7 Additive Distance Constant

The additive distance constant  $K$  of the instrument is adjusted to 0 before delivery. Although it almost never deviates, use a baseline with a known distance precision to check that the additive distance constant  $K$  is close to 0 several times a year and whenever the values measured by the instrument begin to deviate by a consistent amount. Perform these checks as follows.



- Errors in setting up the instrument and reflective prism or in sighting the target will influence the additive distance constant. Be extremely careful to prevent such errors when performing these procedures.
- Set up so that the instrument height and the target height are identical. If a flat place is not available, use an automatic level to make sure the heights are identical.

### PROCEDURE Check

1. Find an area of flat ground where two points 100 m apart can be selected.  
Set up the Instrument at point A and the reflective prism at point B. Establish a point C half way between points A and B.
2. Precisely measure the horizontal distance between point A and point B 10 times and calculate the average value.

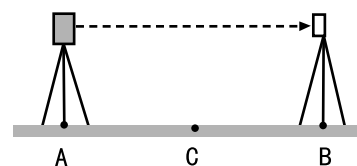

- Place the instrument at point C directly between points A and B and set up the reflective prism at point A.

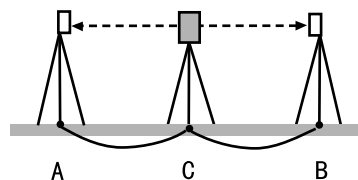

- Precisely measure the horizontal distances CA and CB 10 times each and calculate the average value for each distance.
- Calculate the additive distance constant K as follows.  

$$K = AB - (CA + CB)$$
- Repeat steps 1 to 5 two or three times.  
 If the additive distance constant K is within  $\pm 3\text{mm}$  even once, adjustment is unnecessary.  
 If it always exceeds this range, have our service representative perform an adjustment.

## 21.8 Laser Plummet (Optional Accessory)

Checks and adjustments are performed using an adjustment target. Make an enlarged or reduced copy of the figure below.

### PROCEDURE Checking

- Level the instrument and emit the laser plummet beam.  
 "7.2 Levelling"
- Rotate the upper part horizontally and place a target so that it is aligned with the center of the circle created by the rotating laser plummet beam.
  - Laser beam remains centered on the center of the target – No adjustment necessary.
  - Laser beam strays from the center of the target – Adjustment necessary.
  - Laser beam draws a circle outside the target circle – Contact your local dealer.

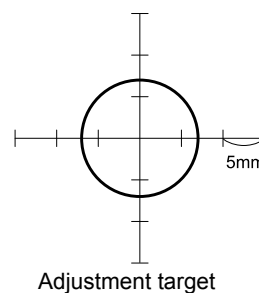

## PROCEDURE Adjusting

1. Turn the laser plummet adjustment cap anticlockwise and remove.

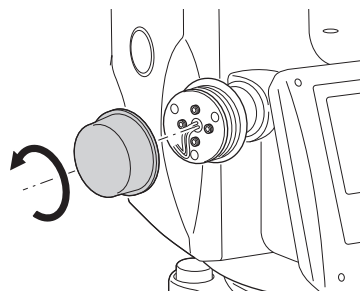

2. Emit the laser plummet beam.
3. Note the current position (x) of the laser beam.
4. Turn the upper part of the instrument horizontally through  $180^\circ$  and note the new position (y) of the laser beam.

Adjustment will bring the laser beam to a point midway along a line drawn between these two positions.

5. Check the position of the desired final position. Place a target so that its center is aligned with the desired final position. The remaining deviation will be adjusted using the 4 fine adjustment screws.



- Be extremely careful to adjust all the fine adjustment screws by the same amount so that none will be over-tightened.
- Turn screws clockwise to tighten.

6. When the laser beam is on the upper (lower) part of Fig. A the up/down adjustment is made as follows:

- ① Insert the provided hexagon key wrench into both the upper and lower screws.
- ② Slightly loosen the upper (lower) screw and tighten the lower (upper) screw. Make sure that the tightening tension for both screws is identical. Continue to adjust until the laser beam is on the horizontal line of the target.

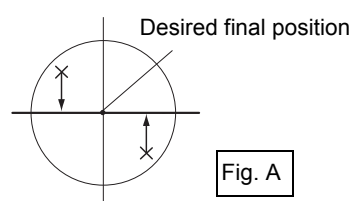
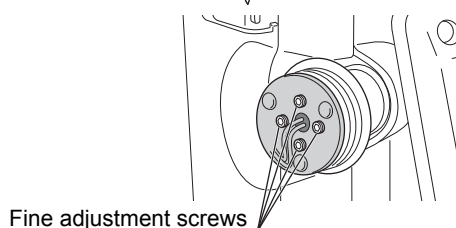
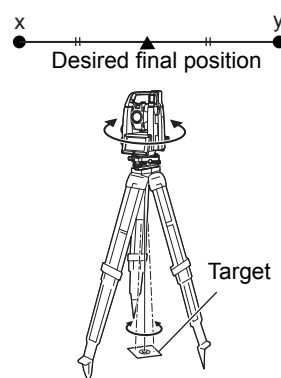

Fig. A

7. When the laser beam is in the right (left) part of Fig. B the left (right) adjustment is made as follows:

- ① Insert a hexagon key wrench into both the left and right screws.
- ② Slightly loosen the right (left) screw and tighten the left (right) screw. Make sure that the tightening tension for both screws is identical. Continue to adjust until the laser beam is aligned with the target center.

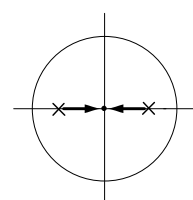
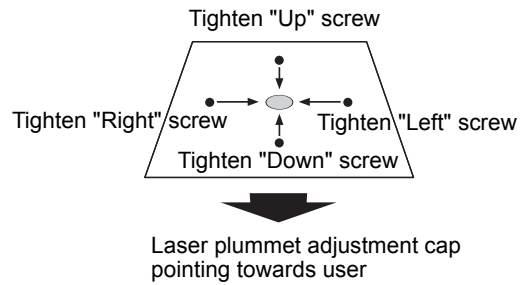
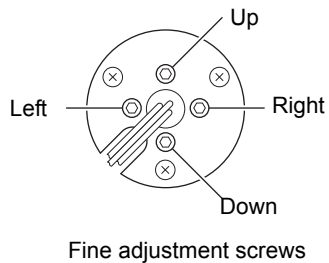

Fig. B

8. Turn the upper part of the instrument horizontally and check that the laser beam is now aligned with the target center.
9. Re-attach the laser plummet adjustment cap.



- Tightening each of the fine adjustment screws moves the laser plummet beam in the directions shown below.



# 22.CLOUD OAF

The iX has a function to update option authorization file (OAF) using the Cloud OAF system. The system allows you to customize and configure the instrument according to your purpose. To update Cloud OAF, you need to purchase a specific optional package in advance. Contact your local dealer for the details of the available options and purchasing process.

Cloud OAF update methods can be chosen from online or offline.



- When updating the firmware, mount a fully charged battery to the total station or use the external battery (optional accessory).

## 22.1 Cloud OAF Online Update

This section explains the procedures of online Cloud OAF update.

### PROCEDURE

1. Select "Cloud OAF" in <Top> to start Cloud OAF program.



2. Press "Option update".

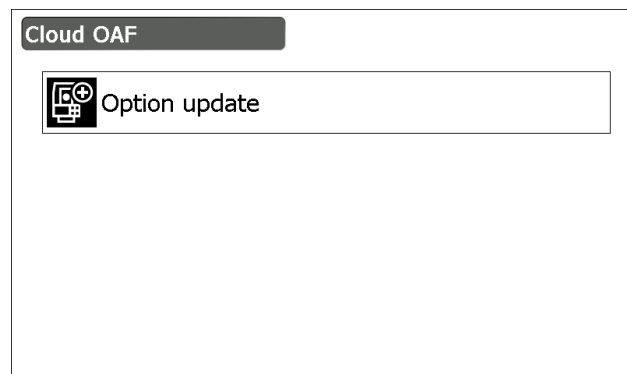

- Press **{ESC}** to quit the update and to display a confirmation message. Press **[YES]** in the message to quit online update. Press **[NO]** to return to the previous screen.

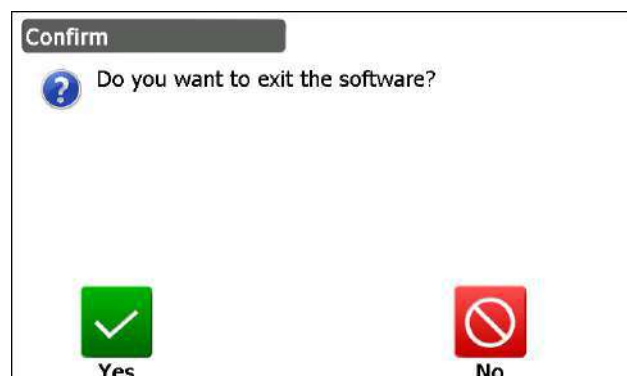

3. Press **[Comms]** in <Network check>.

- Press **[Cancel]** to return to the previous screen.

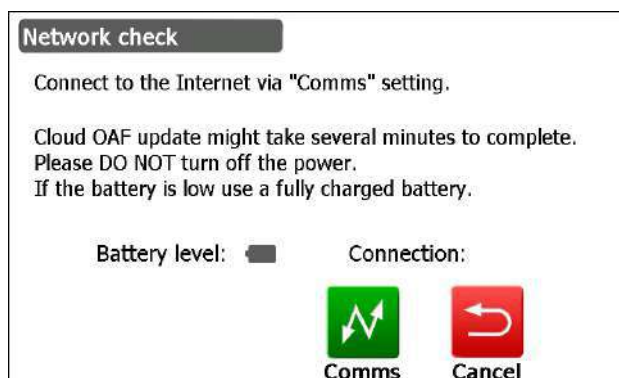

4. Select a connection method and set the communication settings depending on the method.

After setting, press **[Connect]** to establish a network connection. The right is the screen Wireless LAN is selected.

☞ Wireless LAN settings: "9.4 Wireless LAN Settings and Communication" step 3 to 9

☞ Cellular settings: "9.5 Cellular Settings and Communication" step 6 to 8

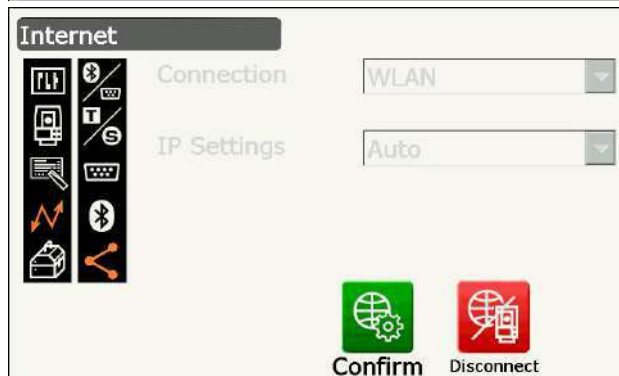

#### Note

- When selecting cellular communication, "Cellular 1" can be selected as an exception during Cloud OAF update.

Cellular 1 : Built-in SIM

Cellular 2 : SIM card inserted to the SIM card slot.

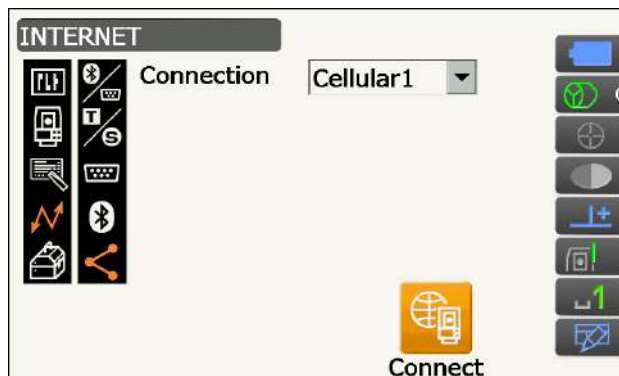

5. Press **{ESC}** to return to <Network check>.



6. Press **[OK]** to start Cloud OAF update.

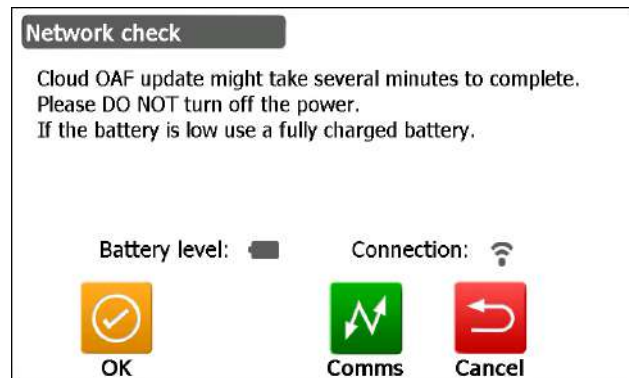

The right screens are displayed during update.

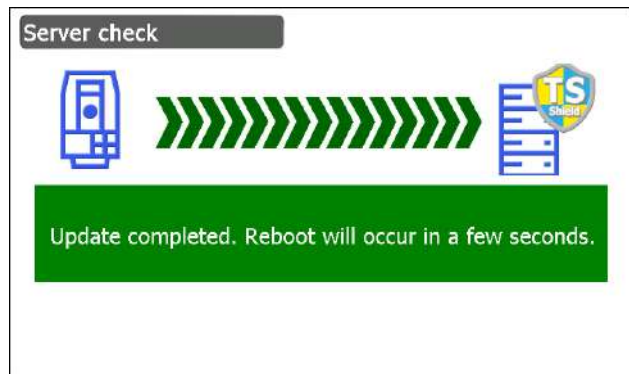
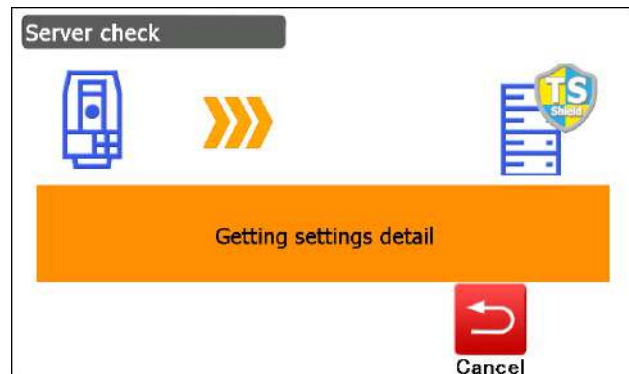

7. When the update is completed, the instrument is restarted automatically.

8. Display the version display mode screen and check if the functions on your instrument are changed. (The right screen is an example)



## 22.2 Cloud OAF Offline Update

This section explains the procedures of offline Cloud OAF update. Save the update file downloaded from the TSshield web site in an USB flash drive and insert it to the instrument.



- When updating, use a blank USB flash drive.
- A warning message may appear in step 3 depending on the browser in use or the settings of the PC; however, the downloaded file does not have a problem.

Reference: On Internet Explorer

Click the **[x]** button to exit the message.

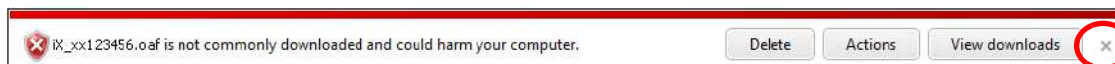

### PROCEDURE

1. Access TSshield web site from your PC.  
Press **[More info]** for the instrument on the Dashboard to display <Instrument page>.
2. Press **[Download]** in the "General Information".

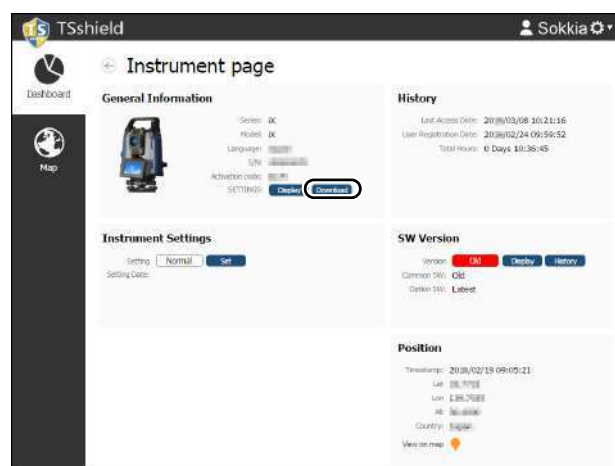

3. Save the update file (xx\_XXXXXX.oaf) in the route folder of a USB flash drive.



- If the destination to save downloaded files is not changed, the downloaded file is saved in "Download" folder.

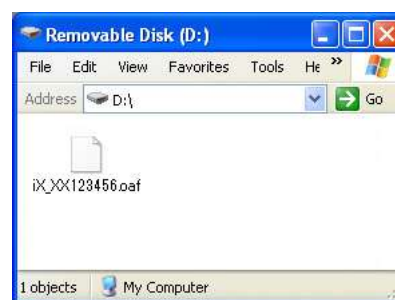

4. Insert the USB flash drive to a USB port of the instrument.
5. After confirming that battery level is sufficient, press the power key on the side of the instrument while holding **{α}** and **{☼}**.

Update starts automatically.

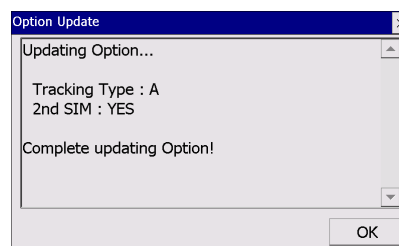

6. When the update is completed, the instrument is restarted automatically.
7. Display the version display mode screen and check if the functions on your instrument are changed.

 "22.1 Cloud OAF Online Update" step 8

# 23. POWER SUPPLY SYSTEM

Operate your instrument with the following combinations of power equipment.

An appropriate prism for Auto Pointing and Auto Tracking measurement: "10. TARGET SIGHTING AND MEASUREMENT Appropriate prism for Auto Pointing and Auto Tracking"



- When using an external battery, mount the BDC70 in place to maintain the balance of the instrument.
- Never use any combination other than those indicated below. If you do, the instrument could be damaged.

Those indicated by \* are standard accessories. Others are optional accessories.

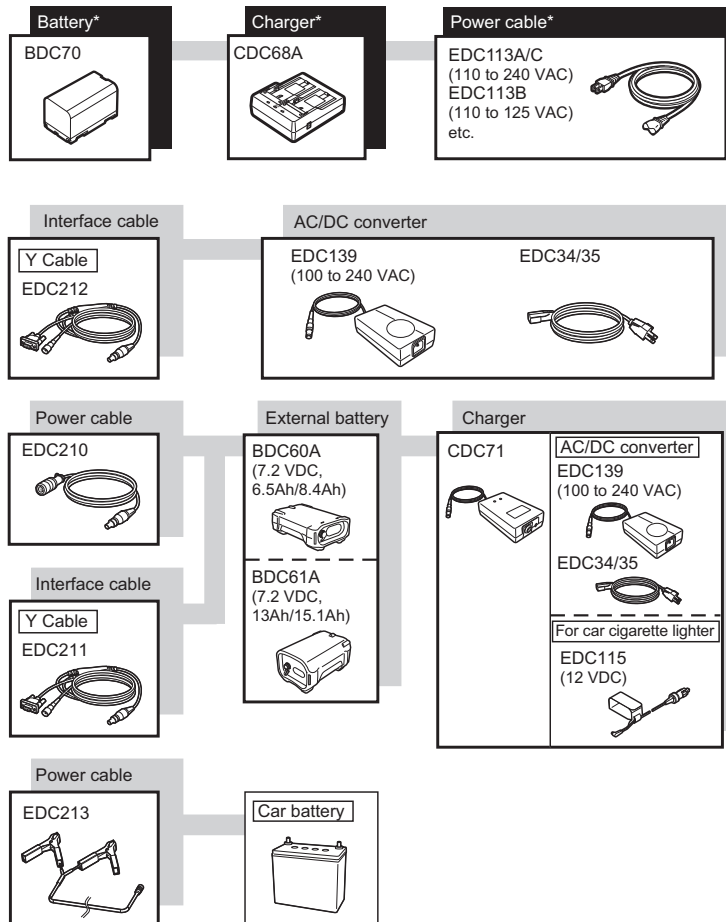

## Note



- Dedicated power cables differ according to the country or the area where the instrument is used. Contact your local dealer for the details.
- By using the Y cable (EDC211) the instrument can perform RS232C communication (D-sub 9-pin) at the same time as connecting to an external power source.

## ● External power supply equipment

- Use an external battery (BDC60A/61A) with the charged standard battery (BDC70) to fulfill the sufficient operating time and to maintain the balance of the instrument.
- When using the Car cigarette lighter cable (EDC115), leave the car engine running. Use the 12 V DC battery with the negative side grounded.
- When using the Power cable (EDC213), be sure to stop the car engine before use. Connect the red clip to the positive side of the 12 V DC battery and the black one to the negative side.

# 24.TARGET SYSTEM

Select a prism or a target depending on your purpose. The following are all special accessories (sold separately).

 An appropriate prism for Auto Pointing and Auto Tracking measurement: "10. TARGET SIGHTING AND MEASUREMENT  Appropriate prism for Auto Pointing and Auto Tracking"



- When using a reflecting prism equipped with a target for distance and angle measurements, be sure to direct the reflective prism correctly and sight the center of the prism target accurately.
- Each reflective prism has its own prism constant value. When changing prisms, be sure to change the prism constant correction value.

## ● Reflecting Prism System (AP Series)

Use an appropriate system for iX.

The figure on the right is an example.

Because all reflecting prisms and accessories have standardized screws, it is possible to combine these prisms, accessories, etc. according to your objectives.

Prism constant correction value : -40 (used alone)

Aperture : 58 mm



## ● 360° Prism (ATP1), 360° Sliding Prism (ATP1SII)

These 360° prisms reduce the possibility of "lost prism" during Auto Tracking measurement regardless of the direction of the prism.

3D positioning accuracy (standard deviation)

: 3mm (Horizontal acceptance angle: 360° (full transit). Angles of elevation and inclination both less than 20°)

Prism constant correction value : -7

Recommended value for aperture: 34 mm



- Recommended value for aperture does not mean the actual aperture of the 360° prism because it is a collection of prisms.



ATP1

ATP1SII

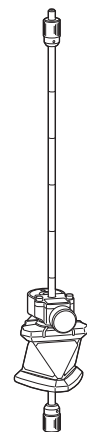

## ● Pinpole prism (OR1PA)

Prism constant correction value : -30 (used alone)

Aperture : 25 mm



## ● Reflective sheet target (RS series)

Prism constant correction value : 0

Aperture : Target size

## ● 2-point target (2RT500-K)

This target is used for two-distance offset measurement.

Prism constant correction value: 0

Aperture : 50 mm

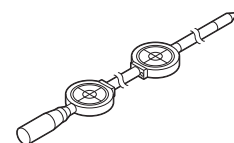

### ● Instrument height adaptor (AP41)

This device is used to adjust the height of the target.

Make sure that the instrument height "239" (mm) is displayed in the instrument height adjustment window.

1. Install the tribrach to the instrument height adaptor.
2. Level the instrument and check the position of the bubble of the plate level.
3. Turn the upper part through 180° and check the bubble position.  
If the bubble is still centered, no adjustment is necessary.  
If the bubble is off-center, adjust as follows.
4. Correct half of the bubble displacement using levelling foot screw C.
5. Correct the remaining half of the displacement by using the adjustment pin to rotate the plate level adjustment screw.  
When the plate level adjustment screw is turned in the counterclockwise direction, the bubble moves in the same direction.
6. Rotate the top of the instrument and continue adjustments until the bubble remains centered for any position of the upper part.
  - Adjust the optical plummet of the AP41 instrument height adaptor following the checking and adjustment methods of optical plummet.  
☞ "21.6 Optical Plummet"

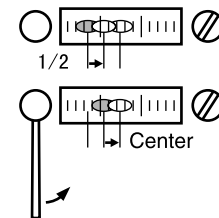
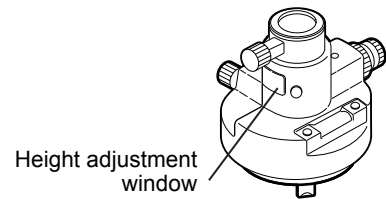

### ● Base Plate (TR-101/102 series)

The circular level on the base plate for prism should be adjusted in the same way with the circular level on the main body.

☞ "21.1 Circular Level"

# 25.ACCESSORIES

The following are outlines and how to use standard accessories (not all) and optional accessories.

The following items are explained in other chapters.

☞ Power supply and target optional accessories: "23. POWER SUPPLY SYSTEM", "24. TARGET SYSTEM".

## ● Carrying case and shoulder belt (standard equipment)

Attach the shoulder belt to the carrying case to shoulder the carrying case.

Be sure to face the surface with instrument name label to your back when shouldering the carrying case. The side with one clasp is the upper surface.

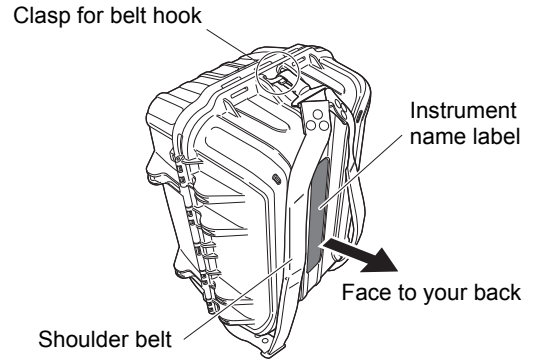

Attach the belt hooks to the clasps on the carrying case shown in the figure on the right.

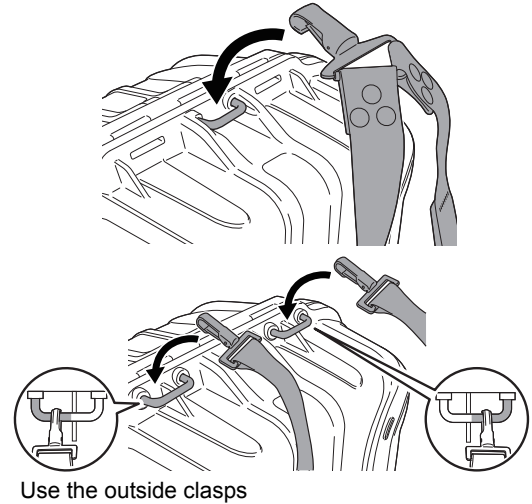

## ⚠ Warning

- Do not attach the belt hooks to the carrying case in the wrong direction. The case or instrument could be dropped and cause injury.

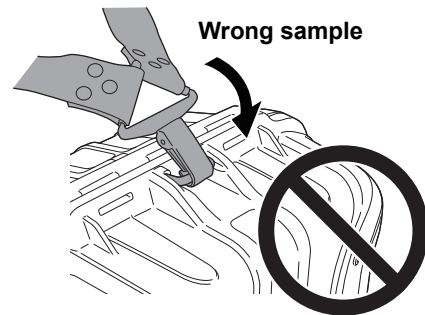

## ● Plumb bob (optional accessory)

The plumb bob can be used to set up and center the instrument on days when there is little wind. To use the plumb bob, unwind its cord, pass it through the cord grip piece as shown in the figure to adjust its length, then suspend it from the hook attached to the centering screw.



● **Circular level for the main unit (L08C) (optional accessory)**

L08C is the circular level to install to the rotating portion of the instrument. The installed level is easy to check its bubble's state, that makes it possible to perform the levelling more quickly.

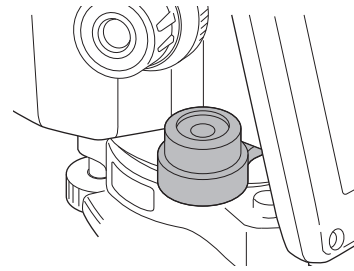

● **Tubular compass (CP7) (optional accessory)**

Slide the tubular compass into the tubular compass slot, loosen the clamp screw, then rotate the top part of the instrument until the compass needle bisects the index lines. The telescope's face 1 sighting direction in this position will indicate magnetic north. After use, tighten the clamp and remove the compass from the slot.

The figure on the right is the standard handle. Mounting method is the same for the RC handle.

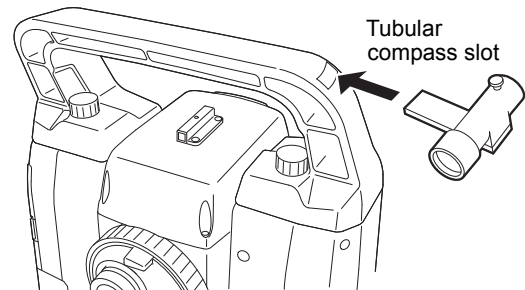

- The tubular compass is susceptible to the influence of nearby magnets or metal. Such influence could cause it to fail to accurately indicate magnetic north. Do not use magnetic north as indicated by this compass for base line surveying.

● **Telescope eyepiece lens (EL8) (optional accessory)**

Magnification : 40X  
Field of view : 1° 7'30"

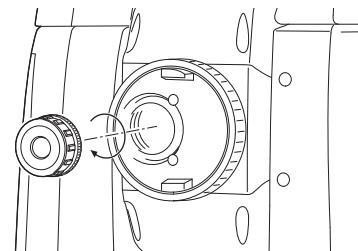

● **Diagonal eyepiece (DE30) (optional accessory)**

The diagonal eyepiece is convenient for observations near the nadir and in narrow spaces.

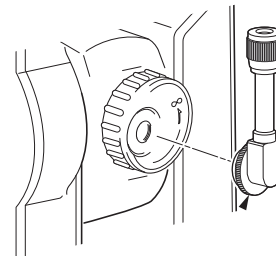

● **Solar filter (OF4) (optional accessory)**

When sighting targets where glare is present, solar observations for example, attach it to the objective lens of the instrument to protect its interior and the eyes of its operator.

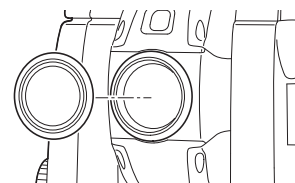



● **Power cable/Interface cable (optional accessory)**

Connect the instrument to a host computer using the following cables.

Cable	Notes
DOC210	Pin number and signal level : RS232C compatible
EDC211 (Y cable)	D-Sub connector : 9 pins (female)
EDC212 (Y cable)	

Note

- By using the Y cable the instrument can perform RS232C communication (D-Sub 9-pin) at the same time as connecting to an external power source.

● **Remote Controller (RC-PR5A) (optional accessory)**

This is the remote controller for Remote Control System which points the instrument (iX) in the direction of the prism with speed and precision.

 Remote Control System Manual



- This system can be used in conjunction with the RC handle.

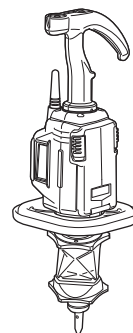

# 26.SPECIFICATIONS

Except where stated, the following specifications apply to all iXs.

## Telescope

Length	142 mm
Aperture	38 mm (1.5 inch) (EDM: 38 mm (1.5 inch))
Magnification	30X
Image	Erect
Resolving power	2.5"
Field of view	1°30' (26 m/1,000 m)
Minimum focus	1.3 m (4.3 ft)
Focussing screw	1 speed
Reticle illumination	5 brightness levels

## Angle measurement

Horizontal and Vertical circles type	Rotary absolute encoder
Detecting	2 sides
IACS (Independent Angle Calibration System)	iX-1001/501 only
Angle units	Degree/Gon/Mil (selectable)
Minimum display	
iX-1001/502:	0.5"(0.0001 gon/0.002 mil)/1" (0.0002 gon/0.005 mil) (selectable)
iX-1003/1005/503/505:	1" (0.0002 gon/0.005 mil)/5" (0.0010 gon/0.020 mil) (selectable)
Accuracy (ISO 17123-3: 2001)	
iX-1001:	1" (0.0003 gon/0.005 mil)
iX-502:	2" (0.0006 gon/0.010 mil)
iX-1003/503:	3" (0.0010 gon/0.015 mil)
iX-1005/505:	5" (0.0015 gon/0.025 mil)
Collimation compensation	On/Off (selectable)
Measuring mode	
Horizontal angle:	Right/Left (selectable)
Vertical angle:	Zenith/Horizontal/Horizontal $\pm 90^\circ$ /% (selectable)

## Tilt angle compensation

Type	Liquid 2-axis tilt sensor
Correction unit	1"
Range of compensation	$\pm 6'$
Automatic compensator	ON (V & H/V)/OFF (selectable)
Tilt offset	Can be changed

## Distance measurement

Measuring method	Coaxial phase-contrast measuring system
Signal source	Red laser diode (690 nm) Class 3R (IEC60825-1 Ed. 3.0: 2014/FDA CDRH 21CFR Part1040.10 and 1040.11 (Complies with FDA performance standards for laser products except for deviations pursuant to Laser Notice No.50, dated June 24, 2007.)) (When target (reflector) is set to prism or reflective sheet, the output is equivalent to Class 1)
Measuring range* <sup>9</sup>	(Using the following reflective prism/reflective sheet target during normal atmospheric conditions* <sup>1</sup> -/ * <sup>2</sup> is good atmospheric conditions)
360° Prism ATP1/ATP1S:	1.3 to 1,000 m (3,280 ft)* <sup>3</sup>

Mini pole prism OR1PA:	1.3 to 500 m (1,640 ft) <sup>*7</sup>
Compact prism CP01:	1.3 to 2,500 m (8,200 ft) <sup>*7</sup>
Standard prism AP01AR X 1:	iX-1000 series: 1.3 to 6,000 m (19,680 ft) <sup>*2, *7</sup> iX-500 series: 1.3 to 4,000 m (13,120 ft) <sup>*2, *7</sup>
Reflective sheet RS90N-K:	1.3 to 500 m (1,640 ft) <sup>*4</sup>
Reflective sheet RS50N-K:	1.3 to 300 m (980 ft) <sup>*4</sup>
Reflective sheet RS10N-K:	1.3 to 100 m (320 ft) <sup>*4</sup>
Reflectorless (White):	iX-1000 series: 0.3 to 800 m (2,620 ft) <sup>*2, *6, *10</sup> iX-500 series: 0.3 to 600 m (1,960 ft) <sup>*2, *6, *10</sup>
Prism (tracking) <sup>*3</sup>	:1.3 to 1,000 m (3,280 ft)
Reflective sheet target (tracking) <sup>*4</sup>	:1.3 to 350 m (1,140 ft)
Reflectorless (White) (tracking) <sup>*5</sup>	:0.3 to 300 m (980 ft)
Minimum display	
Fine measurement:	0.0001m (0.001 ft/ 1/16 inch)/0.001 m (0.005 ft/ 1/8 inch)
Rapid measurement:	0.0001m (0.001 ft/ 1/16 inch)/0.001 m (0.005 ft/ 1/8 inch)
Tracking measurement/Road measurement:	0.001 m (0.005 ft/ 1/8 inch)/0.01 m (0.1ft/ 1/2 inch)
Maximum slope distance display (Except for tracking)	
	9,600.000 m (31,490 ft) (using prism or reflective sheet target)
	1,200.000 m (3,930 ft) (Reflectorless)
Distance unit	m/ft/inch (selectable)
Accuracy (D: measurement distance; Unit: mm) (Under normal atmospheric conditions <sup>*1</sup> , <sup>*7</sup> , <sup>*9</sup> (ISO 17123-4: 2001) (Using prism or using 360° Prism ATP1/ATP1S <sup>*3</sup> )	
iX-1000 series	
Fine measurement: (1.0 + 2 ppm X D) mm	
Rapid measurement: (5 + 2 ppm X D) mm	
iX-500 series	
Fine measurement: (2.0 + 2 ppm X D) mm	
Rapid measurement: (5 + 2 ppm X D) mm	
(Using reflective sheet target) <sup>*4</sup>	
Fine measurement: (2 + 2 ppm X D) mm	
Rapid measurement: (5 + 2 ppm X D) mm	
(Reflectorless (White)) <sup>*5</sup>	
Fine measurement:	(2 + 2ppm X D) mm (0.3 to 200 m) <sup>*8</sup> (5 + 10ppm X D) mm (over 200 to 350 m) (10 + 10ppm X D) mm (over 350 to 1,000 m)
Rapid measurement:	(6 + 2ppm X D) mm (0.3 to 200 m) (8 + 10ppm X D) mm (over 200 to 350 m) (15 + 10ppm X D) mm (over 350 to 1,000 m)
Measurement mode	Fine measurement (single/repeat/average)/Rapid measurement (single/repeat)/Tracking (selectable)
Measuring time	(fastest time under good atmospheric conditions <sup>*2</sup> , no compensation, EDM ALC at appropriate setting, slope distance)
Fine measurement:	less than 1.5 sec + every 0.9 sec or less
Rapid measurement:	less than 1.3 sec + every 0.6 sec or less
Tracking measurement:	less than 1.3 sec + every 0.4 sec or less
Atmospheric correction	
Temperature input range:	- 35 to 60°C (in 0.1°C step)/ - 22 to 140°F (in 0.1°F step)
Pressure input range:	500 to 1,400 hPa (in 0.1hPa step) 375 to 1,050mmHg (in 0.1mmHg step) 14.8 to 41.3inchHg (in 0.01inchHg step)

ppm input range:	-499 to 499 ppm (in 0.1 ppm step)
Prism constant correction	-99 to 99 mm (in 0.1 mm step) 0 mm fixed for reflectorless measurement
Earth curvature and refraction correction	No/Yes K=0.142/Yes K=0.20/Yes (K=Voluntary) (selectable) ("Yes (K=Voluntary)" is selected: Ref. Index can be input (-10.000 to 15.000))
Sea level correction	No/Yes (selectable)

\*1 : Slight haze, visibility about 20 km, sunny periods, weak scintillation.

\*2 : No haze, visibility about 40 km, overcast, no scintillation.

\*3 : Figures when both the elevation and depression angles of the laser beam are within 15° and the instrument is facing the 360° Prism.

\*4 : Figures when the laser beam strikes within 30° of the reflective sheet target.

\*5 : Figures when using Kodak Gray Card White side (reflection factor 90%) and brightness level is less than 5,000 lx.

\*6 : Figures when using Kodak Gray Card White side (reflection factor 90%) and brightness level is less than 500 lx.

\*7 : Face the prism toward the instrument during the measurement with the distance at 10 m or less.

\*8 : Accuracy is (5 + 2 ppm X D) mm for distance range 0.3 to 0.66 m.

\*9 : Figures will change depending on the target reflection factor, weather conditions and location conditions.

\*10: Specifications may vary depending on the model, the country or the area where the instrument is purchased.

#### **Auto Pointing/Auto Tracking (Auto Tracking function is for Auto Tracking model only)**

Measuring method	Pulse laser transmitter and image detector with co-axial optics
Signal source (emitted beam)	Infrared laser diode (980 nm) Class 1 (IEC60825-1 Ed. 3.0: 2014/FDA CDRH 21 CFR Part 1040.10 and 1040.11 (Complies with FDA performance standards for laser products except for deviations pursuant to Laser Notice No.50, dated June 24, 2007.))
Viewing angle	± 45'
Auto Pointing/Auto Tracking angle measuring range	H: 360° (full transit) V: Elevation angle 90° (when handle is attached: Face 1 82°, Face 2 61°), Depression angle 39°*11
Auto Pointing/Auto Tracking distance measuring range*12	
360° Prism ATP1/ATP1S:	2 to 600 m (1,960 ft)*15
Mini pole prism OR1PA:	1.3 to 500 m (1,640 ft)
Compact prism CP01:	1.3 to 700 m (2,290 ft)
Standard prism AP01:	iX-1000 series: 1.3 to 800 m (2,620 ft) iX-500 series: 1.3 to 600 m (1,960 ft)
Reflective sheet RS10/30/50:5 to 50 m (160 ft)*12,*14	
Reflective sheet RS90N-K:	10 to 50 m (160 ft)*12,*14
Auto Tracking speed*12, *16	iX-1000 series: 20°/sec iX-500 series: 15°/sec
Time to completed Auto Pointing*12	(When prism in field-of-view, at 100 m distance)/(using RS90N-K, at 50 m distance) 8 sec. or less
Sighting accuracy (standard deviation)*11	
Prism:	1.2 mm or less (equivalent angle) (to 100 m), (0.3 + 9ppm X D) or less (100 m and over)
Reflective sheet RS90N-K:	2 mm or less*12,*14

- \*11:** Time to completed Auto Pointing may be longer around elevation angle 90°, because the tilt compensation is not in operation.
- \*12:** No haze, visibility over 20 km, slightly overcast (less than 30000 lx), no scintillation.
- \*13:** When using a reflective sheet for Auto Pointing, the size of sheet (10 to 90 mm) must be selected to correspond to the distance being measured. Use smaller reflective sheets for shorter distances.
- \*14:** Figures when the Auto Pointing beam strikes within 15° of the reflective sheet target.
- \*15:** Figures when the Auto Pointing beam strikes within elevation and depression angle 15° of the 360° prism.
- \*16:** Specifications may vary depending on the model, the country or the area where the instrument is purchased.

**Motor**

Type	Direct drive by ultrasonic motor
Motion range	360°(Vertical and horizontal)
Rotation speed <sup>*17</sup>	iX-1000 series: 150°/sec (at 20°C) iX-500 series: 85°/sec (at 20°C)
Fine motion	Jogs

- \*17:** Specifications may vary depending on the model, the country or the area where the instrument is purchased.

**Guide Light**

Light source	LED (red 626 nm/green 524 nm)
Visible distance range	1.3 to 150 m <sup>*18</sup>
Visible angle range	Right and Left/Upward and Downward: ± 4° (7 m/100 m) (Brightness level is less than 80,000 lx. <sup>*19</sup> when right and left: within ± 4°, upward and downward: ± 3°, less than 40,000 lx. <sup>*18</sup> when right and left: within ± 4°, upward and downward: ± 3 to 4°)
Resolving power at center area (width)4'	(about 0.12/100 m)
Brightness	3 levels (bright/normal/dim)

- \*18:** Slightly overcast, the sun is seen, and dim shadows are cast on the ground.
- \*19:** Clear and sunny, the sun is positioned at 50° or more, sighting the target from the instrument.

**Internal memory**

Capacity	1 Gbyte (includes memory for program files)
----------	---------------------------------------------

**External memory**

USB flash memory (up to 32GB)

**Data transfer**

Data input/output	Asynchronous serial, RS232C compatible
USB	USB Ver. 2.0, Host (Type A) and Client (Type miniB)

**Handle (Remote Control System Beam Detector)**

Operable range (Slope distance when using RC-PR5A under normal atmospheric conditions <sup>\*1)</sup>

Standard mode	2 <sup>*20</sup> to 100 m <sup>*21</sup>
Far mode	2 <sup>*20</sup> to 250 m <sup>*22</sup>
	2 <sup>*20</sup> to 300 m <sup>*21</sup>

Maximum detecting area (vertical angle)

±30° (on the basis of horizontal direction)

Remote Control System Turning operation time (RC-PR5A)

15 sec or less (until completion of rapid (single) measurement)

**\*20:** When there is almost no vertical interval between instrument height and the target height, the instrument height is 1.5 m, target height is 0.10 m at a horizontal distance of 1.8 m

**\*21:** When the vertical interval between iX and the beam emitter of Remote Controller is no more than 20 m

**\*22:** When the vertical interval between iX and the beam emitter of Remote Controller is no more than 40 m

**Bluetooth wireless communication <sup>\*23</sup>**

Transmission method	FHSS
Modulation	GFSK
Frequency band	2.402 to 2.48GHz
Bluetooth profile	SPP, DUN
Power class	Class 1
Usable range	to 600 m (while in communication with RC-PR5A) <sup>*24, 25</sup>

**\*23:** Bluetooth function may not be built in depending on telecommunications regulations of the country or the area where the instrument is purchased. Contact your local dealer for the details.

**\*24:** No obstacles, few vehicles or sources of radio emissions/interference in the near vicinity of the instrument, no rain.

**\*25:** Usage range could be shorter depending on specifications of Bluetooth device to communicate.

**Wireless LAN communication**

Communication distance	10 m (indoor condition) <sup>*26, 27</sup>
Transmission specifications	IEEE802.11g/IEEE802.11b/IEEE802.11n
Access method	Infrastructure mode, adhoc mode
Frequency range	2,412 to 2,472MHz (1 to 11 ch)

**\*26:** No obstacles, few vehicles or sources of radio emissions/interference in the near vicinity of the instrument, no rain.

**\*27:** Usage range could change depending on the communication conditions.

**Telematics system**

Cellular	3G/2G
GPS <sup>*28</sup>	L1 (for position monitoring)
User SIM	mini-SIM (2FF) (25 X 15 X 0.76 mm) <sup>*29</sup>

**\*28:** Instrument position may not be detected when mountain, building, power line, tree branch etc. block signal reception from the satellites.

**\*29:** Do not use SIM card converter adaptor. Inserted adaptor may not be taken out or it may damage the inside of the SIM card slot.

**Power Supply**

Power source	Rechargeable Li-ion battery BDC70
Working duration at 20 °C <sup>*30</sup>	
BDC70:	about 4hours
BDC60A (external battery, optional accessory) + BDC70:	about 9 hours <sup>*31</sup>
BDC61A (external battery, optional accessory) + BDC70:	about 14 hours <sup>*31</sup>
Battery state indicator	4 levels
Auto power-off	5 levels (5/10/15/30 min/Not set) (selectable)
External power source	6.7 to 12V

**Battery (BDC70)**

Nominal voltage:	7.2V
Capacity:	5,240mAh
Dimensions:	40 (W) x 70 (D) x 40 (H) mm
Weight:	about 197g

**Charger (CDC68A)**

Input voltage:	100 to 240VAC
Charging time per battery (at 25°C):	
BDC70:	about 5.5 hours (Charging can take longer than the times stated above when temperatures are either especially high or low.)
Charging temperature range:	0 to 40°C
Storage temperature range:	-20 to 65°C
Size:	94 (W) X 102 (D) X 36 (H) mm
Weight:	about 170g

**\*30:** Figures will change depending on the operating environment including temperatures and observation conditions.

**\*31:** Figures when using the instrument with both an external battery and a standard battery mounted.

**General**

Operating system	Windows Embedded Compact 7
Display	4.3 inch Transmissive TFT VWGA color LCD
Backlight:	LED: 9 brightness levels (0 to 8) (selectable)
Touch panel:	Resistance-sensitive analog type
Keyboard	24 keys
	Key backlight:Yes
Trigger key	Yes (right side)
Sensitivity of levels	
Circular level (on base plate):	10'2 mm
Circular level (for main unit) (optional accessory):	8'2 mm
Electronic Circular levels:	Graphic display range: 6' (inner circle) Digital display range:±6' 30"
Optical plummet	
Magnification:	3X
Field of view:	4°
Image:	Erect
Minimum focus:	0.5 m
Circular level:	10'2 mm

## Laser plummet (optional accessory)

Signal source:	Red laser diode 635 ±10 nm (Class 2 IEC60825-1 Ed.3.0: 2014/FDA CDRH 21CFR Part 1040.10 and 1040.11 (Complies with FDA performance standards for laser products except for deviations pursuant to Laser Notice No.50, dated June 24, 2007.))
Beam accuracy:	1 mm or less (when tripod head height is 1.3m).
Spot diameter:	ø3 mm or less
Brightness control:	5 levels
Auto power-off:	Provided (power cut off after 5 minutes)
Calendar/clock function	Yes
Laser-pointer function	ON/OFF (selectable)
Operating temperature range	-20 to 50°C (-4 to 122°F)
Storage temperature range	-30 to 60°C (-22 to 140°F) (no condensation)
Dust and water resistance	IP65 (IEC 60529: 2001)
Instrument height	192.5 mm from tribrach mounting surface
Size (with handle)	
Display on one side:	212 (W) X 172 (D) X 355 (H) mm
(Display on both sides:	212 (W) X 195 (D) X 355 (H) mm)
Weight	5.8 kg (12.8 lb) (with BDC70 and RC handle) 5.7 kg (12.6 lb) (with BDC70 and standard handle)



# 27.EXPLANATIONS

## 27.1 High Accuracy with the 360° Prism

Sighting can be more accurately performed by facing the 360° Prism toward the instrument. The 360° Prism should be set up so that a pair of diametrically-opposed hexagonal points on its rubber flanges are aligned with the sighting direction of the instrument (see the diagram below).

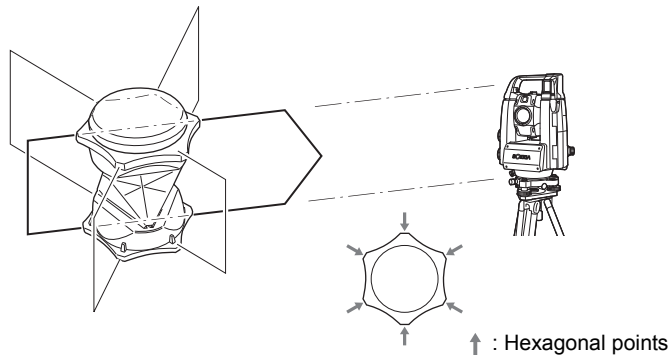

When using the ATP1SII, the 360° Prism should be set up so that a pair of diametrically-opposed marks on top of the prism are aligned with the sighting direction of the instrument.

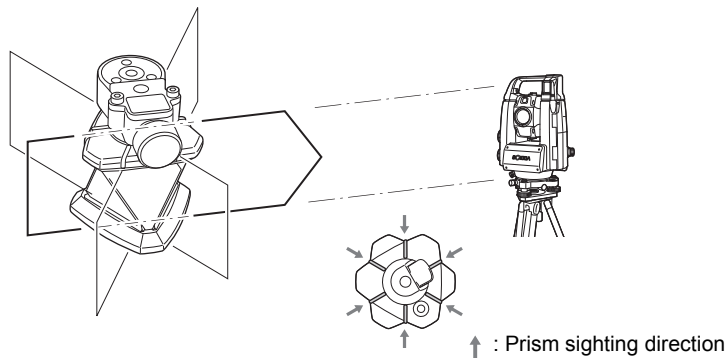

## 27.2 Manually Indexing the Vertical Circle by Face 1/2 Measurement

The 0 index of the vertical circle of your instrument is almost 100% accurate, but when it is necessary to perform particularly high precision vertical angle measurements, you can eliminate any inaccuracy of the 0 index as follows.



- If the power is cut off, the vertical circle indexing is ineffective. Do it again every time the power is turned on.
- If it necessary to renew the registered collimation offset constant in your instrument, perform the collimation checking and adjusting.

 "21.4 Collimation"

### PROCEDURE

1. Select "Instrument" in <Inst. config.>. Set "V manual" (vertical circle indexing method) to "Yes".  
 "19.7 Instrument Conditions - Instrument"

<V manual 0 set> is displayed.



2. Carefully level the instrument.
3. Accurately sight a clear target with a distance of 30 m or more in the horizontal direction with the telescope in Face 1.  
Press **[OK]**. The vertical angle V2 is displayed under "Take F2".
4. Turn the upper part through 180° and clamp it.  
Then set the telescope in the Face 2 position and accurately sight the same target.  
Press **[OK]**.  
The vertical and horizontal angles are displayed.  
This concludes the vertical circle indexing procedure.

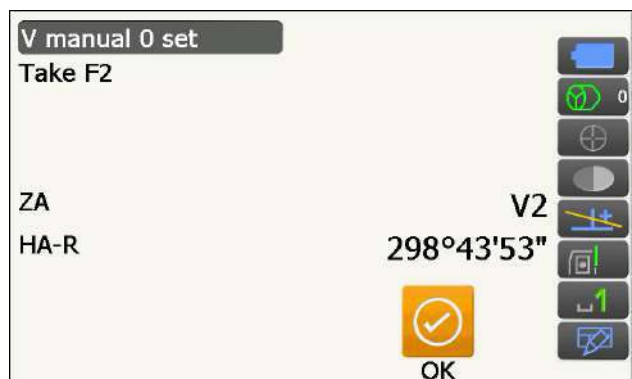

### 27.3 Correction for Refraction and Earth Curvature

The instrument measures distance, taking into account correction for refraction and earth curvature.

#### Distance Calculation Formula

Distance Calculation Formula; with correction for refraction and earth curvature taken into account. Follow the Formula below for converting horizontal and vertical distances.

Horizontal distance  $D = AC(\alpha)$

Vertical distance  $Z = BC(\alpha)$

$D = L\{\cos\alpha - (2\theta - \gamma) \sin\alpha\}$

$Z = L\{\sin\alpha + (\theta - \gamma) \cos\alpha\}$

$\theta = L \cdot \cos\alpha / 2R$  : Earth curvature correcting item

$g = K \cdot L \cos\alpha / 2R$  : Atmospheric refraction correcting item

$K = 0.142$  or  $0.2$  : Coefficient of refraction (Ref.index)

$R = 6371\text{km}$  : Radius of earth

$a$  : Altitude angle

$L$  : Slope distance

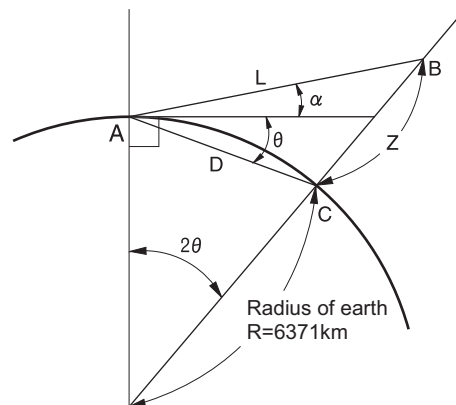



 Changing Coefficient of refraction value K (Ref.index): "19.1 Observation Conditions - Angle/Tilt"

# 28.REGULATIONS

Region/ Country	Directives/ Regulations	Labels/Declarations
U.S.A.	FCC-Class A	<p><b>FCC Compliance</b></p> <p><b>WARNING:</b> Changes or modifications to this unit not expressly approved by the party responsible for compliance could void the user's authority to operate the equipment.</p> <p><b>NOTE:</b> This equipment has been tested and found to comply with the limits for a Class A digital device pursuant to Part 15 of the FCC Rules. These limits are designed to provide reasonable protection against harmful interference when the equipment is operated in a commercial environment. This equipment generates, uses, and can radiate radio frequency energy and, if not installed and used in accordance with the operator's manual, may cause harmful interference to radio communications. Operation of this equipment in a residential area is likely to cause harmful interference in which case the user will be required to correct the interference at his own expense.</p> <p><b>Means of conformity</b> This device complies with part 15 of the FCC Rules, Operation is subject to the following two conditions: (1) This device may not cause harmful interference, and (2) this device must accept any interference received, including interference that may cause undesired operation.</p> <p>This transmitter must not be co-located or operated in conjunction with any other antenna or transmitter.</p> <p>This equipment complies with FCC radiation exposure limits set forth for uncontrolled equipment and meets the FCC radio frequency (RF) Exposure Guidelines. This equipment has very low levels of RF energy that is deemed to comply without maximum permissive exposure evaluation (MPE). But it is desirable that it should be installed and operated keeping the radiator at least 20cm or more away from persons body.</p>
California, U.S.A	Proposition 65	<div style="border: 1px solid black; padding: 5px;"> <p><b>WARNING :</b> Handling the cord on this product or cords associated with accessories sold with this product, will expose you to lead, a chemical known to the State of California to cause birth defects or other reproductive harm. <b><i>Wash hands after handling.</i></b></p> </div>
California, U.S.A	Perchlorate Material (CR Lithium Battery)	<div style="border: 1px solid black; padding: 5px;"> <p>This product contains a CR Lithium Battery which contains Perchlorate Material-special handling may apply. See <a href="http://www.dtsc.ca.gov/hazardouswaste/perchlorate/">http://www.dtsc.ca.gov/hazardouswaste/perchlorate/</a> Note ; This is applicable to California, U.S.A. only</p> </div>

Region/ Country	Directives/ Regulations	Labels/Declarations
California and NY, U.S.A.	Recycling Batteries	<p style="text-align: center;"><u>DON'T THROW AWAY RECHARGEABLE BATTERIES, RECYCLE THEM.</u></p> <p style="text-align: center;"><b><u>Topcon Positioning Systems Inc., United States Return Process for Used Rechargeable Nickel Metal Hydride, Nickel Cadmium, Small Sealed Lead Acid, and Lithium Ion, Batteries</u></b></p> <p>In the United States Topcon Positioning Systems Inc., has established a process by which Topcon customers may return used rechargeable Nickel Metal Hydride(Ni-MH), Nickel Cadmium(Ni-Cd), Small Sealed Lead Acid(Pb), and Lithium Ion(Li-ion) batteries to Topcon for proper recycling and disposal. Only Topcon batteries will be accepted in this process.</p> <p>Proper shipping requires that batteries or battery packs must be intact and show no signs of leaking. The metal terminals on the individual batteries must be covered with tape to prevent short circuiting and heat buildup or batteries can be placed in individual plastic bag. Battery packs should not be disassembled prior to return.</p> <p>Topcon customers are responsible for complying with all federal, state, and local regulations pertaining to packing, labeling, and shipping of batteries. Packages must include a completed return address, be prepaid by the shipper, and travel by surface mode. <b><u>Under no circumstance should used/recyclable batteries be shipped by air.</u></b></p> <p>Failure to comply with the above requirements will result in the rejection of the package at the shipper's expense.</p> <p>Please remit packages to: Topcon Positioning Systems, Inc. C/O Battery Return Dept. 150 7400 National Dr. Livermore, CA 94551</p> <p style="text-align: center;"><u>DON'T THROW AWAY RECHARGEABLE BATTERIES, RECYCLE THEM.</u></p>
Canada	ICES-Class A	<p>This Class A digital apparatus meets all requirements of Canadian Interference-Causing Equipment Regulations. Cet appareil numérique de la Class A respecte toutes les exigences du Règlement sur le matériel brouilleur du Canada.</p> <p>This class A digital apparatus complies with Canadian ICES-003. Cet appareil numérique de la classe A est conforme a la norme NMB-003 du Canada.</p> <p>Operation is subject to the following two conditions: (1) this device may not cause interference, and (2) this device must accept any interference, including interference that may cause undesired operation of this device. This equipment complies with IC radiation exposure limits set forth for an uncontrolled environment and meets the RSS-102 of the IC radio frequency (RF) Exposure Guidelines.</p> <p>This equipment has very low levels of RF energy that it deemed to comply without maximum permissive exposure evaluation (MPE). But it is desirable that it should be installed and operated keeping the radiator at least 20cm or more away from person's body.</p>

Region/ Country	Directives/ Regulations	Labels/Declarations
EU	EMC-Class A R&TTE- Class 1	<p><b>EMC NOTICE</b></p> <p>In industrial locations or in proximity to industrial power installations, this instrument might be affected by electromagnetic noise. Under such conditions, please test the instrument performance before use.</p> <p>This product complies with the electromagnetic environmental testing of industrial locations.</p> <p>Model : iX series</p> <p>Manufacturer Name : TOPCON CORPORATION Address : 75-1, Hasunuma-cho, Itabashi-ku, Tokyo, 174-8580 JAPAN</p> <p><b>Europe Representative</b> Name : Topcon Europe Positioning B.V. Representative Director: Jim Paetz Address : Essebaan 11, 2908 LJ Capelle a/d IJssel, The Netherlands</p> 
EU	WEEE Directive	 <p><b>WEEE Directive</b> This symbol is applicable to EU members states only.</p> <p>Following information is only for EU-member states: The use of the symbol indicates that this product may not be treated as household waste. By ensuring this product is disposed of correctly, you will help prevent potential negative consequences for the environment and human health, which could otherwise be caused by inappropriate waste handling of this product. For more detailed information about the take-back and recycling of this product, please contact your supplier where you purchased the product or consult.</p>
EU	EU Battery Directive	 <p><b>EU Battery Directive</b> This symbol is applicable to EU members states only.</p> <p>Battery users must not dispose of batteries as unsorted general waste, but treat properly. If a chemical symbol is printed beneath the symbol shown above, this chemical symbol means that the battery or accumulator contains a heavy metal at a certain concentration. This will be indicated as follows: Hg: mercury(0.0005%), Cd: cadmium(0.002%), Pb: lead(0.004%)</p> <p>These ingredients may be seriously hazardous to human and the global environment.</p> <p>This product contains a coin cell. You cannot replace batteries by yourself. When you need to replace and/or dispose batteries, contact your local dealer.</p>

# 29.INDEX

<b>A</b>	
ACK mode .....	38
Adjusting backlight brightness/turning the reticle illumination and key backlight ON/OFF .....	117
Appropriate prism for Auto Pointing and Auto Tracking .....	52
Atmospheric correction factor .....	115
AUTO AIM .....	54
Automatic tilt angle compensation mechanism .....	109
<b>B</b>	
Backlight Off .....	117
<i>Bluetooth</i> connection mode .....	36
<i>Bluetooth</i> device address .....	39
<b>C</b>	
Cold boot .....	35
Collimation correction .....	109
Color setting .....	117
<b>D</b>	
Date and Time .....	122
Difference in search and measuring distance operation .....	57
Dist.reso. (Distance resolution) .....	111
DNS server and WINS server .....	44
<b>E</b>	
EDM ALC .....	111
Eliminating parallax .....	59
<b>G</b>	
Guide light .....	10
<b>H</b>	
Hdist .....	110
Horizontal angle settings .....	74, 80
Horizontal jog .....	10
<b>I</b>	
Inch (Fraction of an inch) .....	120
Instrument height mark .....	9
<b>K</b>	
Key backlight .....	117
<b>L</b>	
Laser-pointer function .....	9
Laser-pointer off .....	119
Lost Prism .....	57
<b>P</b>	
Power off .....	118
Power off (Remote) .....	118
Power-saving mode .....	117
Precaution when performing resection .....	84
Prism constant correction value .....	112
Problems Powering OFF .....	35
<b>R</b>	
Resection calculation process .....	83
Resume function .....	33
Road .....	110
<b>S</b>	
Scale factor .....	111
Sea level correction .....	110
Search operation during Auto pointing .....	55
Search pattern .....	55
Sighting collimator .....	10
Sighting manually .....	59
Slope area .....	105
Srch method .....	54

**T**

Terminate .....	38
Tracking Meas. ....	55
Tracking reso. (Tracking resolution) .....	111
Trigger key .....	10
TURN .....	55
Turning operation .....	58

**V**

V mode (vertical angle display method) .....	109
Vertical Jog .....	10



---

## **TOPCON CORPORATION**

75-1 Hasunuma-cho, Itabashi-ku, Tokyo 174-8580, Japan <http://www.topcon.co.jp>

Please see the attached address list or the following website for contact addresses.

**GLOBAL GATEWAY** <http://global.topcon.com/>

---

©2016 TOPCON CORPORATION  
ALL RIGHTS RESERVED