



SBS-8400

BATTERY CAPACITY TESTER

USER MANUAL

Rev. 2.1 12-14

STORAGE BATTERY SYSTEMS, LLC

N56W16665 Ridgewood Dr., Menomonee Falls WI 53051

Phone: (800) 554-2243 Fax: (262) 703-3073 Website: www.sbsbattery.com

Contents

1. Introduction

- 1.1 Features
- 1.2 System Components

2. Main Technical Parameter

- 2.1 Environment & Conditions for Use
- 2.2 Structure & Weight
- 2.3 Working Power Supply
- 2.4 Input Voltage from Battery strings
- 2.5 Discharge Current Range
- 2.6 Parameter Display & Measure Accuracy
- 2.7 Protection & Warning
- 2.8 Data Management & Communication

3. Basic Operational Principle

- 3.1 Battery Testing Principle
- 3.2 Constant Current Principle

4. Operating Instructions

- 4.1 Environments Requirement
- 4.2 Panel Description
- 4.3 Main Machine Connection
- 4.4 Wireless Modules Connection
- 4.5 Starting Up and Input Operation
- 4.6 Check the Connection of the Wireless Modules
- 4.7 The Preset Function
- 4.8 Discharge
- 4.9 Download the Data to PC
- 4.10 System Setup
- 4.10.7 Calibration
- 4.11 Charge Monitoring Function
- 4.12 Multiple units in parallel

5. PC Software Instruction

- 5.1 Main Functions
- 5.2 Install Analysis Software to PC
- 5.3 Real Time Recording During the Testing
- 5.4 Download Data File from USB Disk
- 5.5 Generate Excel Test Report

6. Precautions

7. After-Sale Service

1. Introduction

Battery-based backup systems have become an ever-increasing source of providing emergency power to critical systems and components. Maintaining these systems and knowing that they will be able to perform when called upon in an emergency has led to an increasing demand for testing methods to guarantee reliable operation. In addition, new requirements and recommendations (FERC, NERC, IEEE, etc...) are requiring more stringent attention to the reliability and performance of batteries used in these critical applications.

As we know, there are many factors which determine the actual service life that a battery string will reliably perform before failures or reduction in capacity requires replacement. While period maintenance and routine monitoring of measurements gives you some idea of a battery's condition, it is only by actually testing the capacity of the battery string that you know what its capabilities are and how close it is to its end of useful service life.

With these ideas in mind, SBS has developed the SBS-8400 as an advanced, highly accurate and intellectual testing system for conducting load testing of battery strings. With innovative features, such as wireless data collection, real time monitoring, and integrated software, the SBS-8400 is the tool of choice for consistent, reliable and affordable battery capacity testing.

Advantages of the SBS-8400:

- a) **Wireless battery monitoring technology** - Available for 1.2V/2V/6V/12V cells voltage monitoring.
- b) **Each wireless module can monitor 4 cells simultaneously** - Compared with traditional methods where each module can only monitor 1 cell, the new module design requires only a quarter of the number of old-fashioned modules. (Only 6 wireless modules for 48V battery strings.)
- c) **Parallel monitoring of multiple battery strings** - The SBS-8400 can simultaneously record the actual discharge currents and voltages of each battery strings under test. (Accessories, extra current clamps are needed for multi-string testing.)
- d) **Automated constant current control during on-line tests** - During the discharge, the current displayed in the LCD = the discharge current of battery string. The SBS-8400 is capable of monitoring the current created by the main machine + the current of the actual load. This allows for testing the battery system and automatic adjustment based on the system real and artificial load.
- e) **Selectable number of low voltage limits** - This feature allows the test to continue instead of stopping as soon as the first cell reaches the low cell voltage setting and allows for testing to continue after a weak / bad cell is jumped out of the string.

- f) **Simplified menu design** - The simplified menu allows for easy test set up and operation.
- g) **Light weight alloy heat sink elements** - New generation materials increase safety and thermal transfer of heat to air.
- h) **Auto scan and display of the voltage data for each battery during the discharge**
Graphical histograms display the status of each cell throughout the discharge, and the use of different colors to highlight the lowest and the highest voltage can simplify the identification of possible problems.
- i) **5.7 inch colorful touching LCD screen** - The large touchscreen allows menu selection and programming, and shows all parameters and the voltage histogram during the discharging process.
- j) **Intelligent judgment program** - SBS-8400 continuously monitors voltages and regulates test progress to shutdown parameters. Automatic adjustment of discharge current level allows this revolutionary program to keep the test stable and smooth.
- k) **Presetting function for discharge parameters** - SBS-8400 provides 30 presets for setting up discharge parameters in advance; this design can simplify the programming operation and speed up testing.
- l) **Real Time PC Logging**- Powerful software for downloading real time data, or use the USB port to download the data after the discharging process. PC analysis software assists users in analysis of the data and creation of test reports.
- m) **8M internal memory** - SBS-8400's internal memory can record several sets of test result data independently and the menu interface provides basic management operations like reviewing, analyzing or deleting test results.

The Advantages / Features of SBS-8400 Analysis Software:

- a) Allows data downloading and analysis through real time communications or USB memory device downloads.
- b) The software interface includes: battery/cell voltages curves and bar charts, group voltage curve, current curve, capacities histogram and a raw data matrix.
- c) Powerful capacity calculating function - the software calculates the capacity of each battery in the tested group.
- d) The software shows the data in various forms such as bar charts, curves, and table formats. Users can magnify or minimize any windows to view more details.
- e) Automatically creates EXCEL data reports; convenient to send or download the data.

SBS-8400 has multiple protective functions, which include the audible alarms, warning lights and clear interface prompts.

SBS-8400 is a compact, lightweight, simple to operate and highly accurate testing platform. SBS-8400 is versatile in its ability to discharge test 12V, 24V, 48V, 72V, 96V, 110V, 120V, 220V, 240V battery strings etc., across many applications.

1.2 System Components

The SBS-8400 battery capacity tester includes the main machine, wireless modules for cells monitoring (optional), wireless signal receiver and PC analysis software.

The main unit consists of a color LCD screen, data processing unit, data monitoring unit, auxiliary power unit, power consumption unit and panel operation unit.

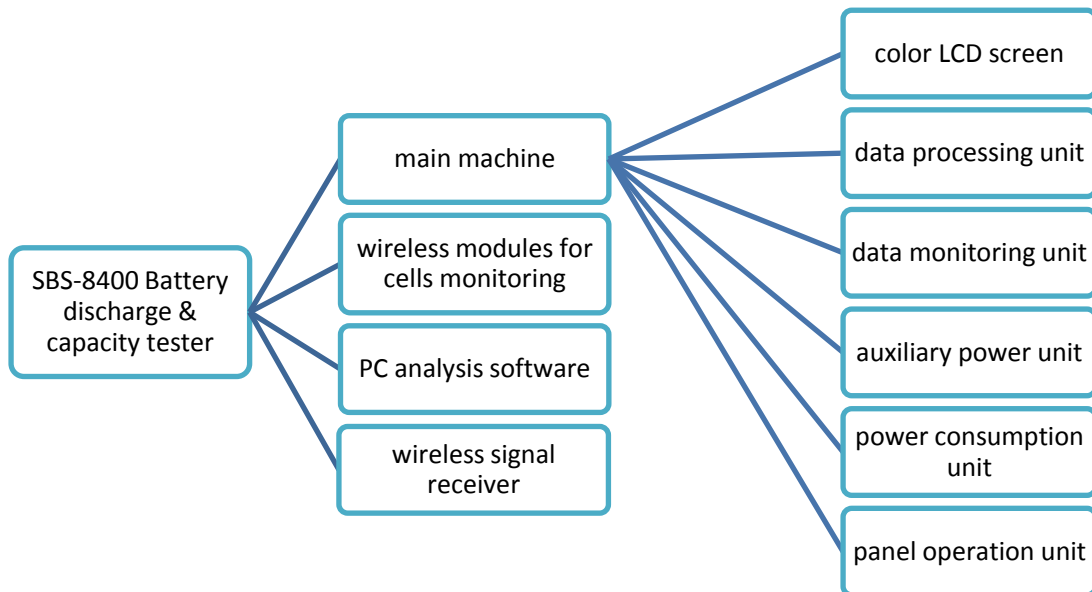

2. Technical Parameters

2.1 Environment & Conditions for Use

2.1.1 Operating temperature:

20°F ~ 122°F (-5°C ~ +50°C), full power, forced air cooling

2.1.2 Storage temperature:

-40°F ~ 150°F (-40°C ~ +70°C)

2.1.3 Relative humidity:

≤90% 105°F±5°F (40°C±2°C)

2.1.4 Altitude limit:

0~2000m, 20°F ~ 122°F (-5°C~+50°C), full power

2000m~4000m, 20°F ~ 90°F (-5°C~+30°C), full power;

90°F ~ 122°F (30°C~+50°C), 80% of ratings.

2.2 Structure & Weight

Dimensions: (length*width*height):

SBS-8400: 26.4" x 9.05" x 14.6" (670mm x 230mm x 370mm)

Weight:

SBS-8400: 52.9 lbs. (24 kg) {main tester only}

2.3 Working Power Supply

SBS-8400: AC 120V single phase 45Hz~65Hz (220VAC optional)

2.4 Input Voltage from Battery String

SBS-8400: 10 ~ 300V

2.5 Discharge Current Range

Voltage range	Current range
10-15V	0-60 A
15V-60V	0-120 A
86-150V	0-120 A
190-280V	0-60 A

2.6 Display & Measurement Accuracy

LCD Display: 5.7 inch LCD color touch screen

Displayed discharge current: resolution 0.1A
accuracy $\leq\pm 0.5\%$

Displayed battery strings voltage: resolution 0.1V
accuracy $\leq\pm 0.5\%$

Displayed cells voltage: 1.2V/2V/6V cells resolution 0.001V
accuracy $\leq\pm 0.05\%$
12V cells resolution 0.01V
accuracy $\leq\pm 0.05\%$

2.7 Protection & Warning

Protection features of the SBS-8400:

2.7.1 DC input overvoltage, polarity reversal at battery connection, DC over current during discharge, and system over temperature.

2.7.2 Warning light and audible alert will activate, and the LCD screen will show message / prompt.

2.8 Data Management & Communication**2.8.1** Discharge data management

- Data sampling is saved continuously and automatically, so test records are not lost even due to a loss of power.
- Allows for manual review of data.
- Allows for reading & downloading data via the communication port.
- Displays the remaining capacity of the internal memory.
- Smart delete selection: delete all or delete the selected record from memory.

2.8.2 Preset Test Parameters

The “Preset” interface allows the user to program and store in the internal memory of the SBS-8400 up to 30 test preset parameters for quick selection and setup.

2.8.3 Communication

- a) Internal wireless signal receiver allows the SBS-8400 main unit to record the cell monitoring & sampling data.
- b) Via the RS232 port in SBS-8400 main unit, a PC can be connected to display real time discharge data.
- c) Via the USB port in SBS-8400 main unit, test result data can be transferred to a PC by a USB-disk.
- d) Via the Parallel control port, SBS-8400 main unit can control a SBS-S series DC load bank.

3. Basic Operational Principles

3.1 Battery Testing Principle

Because of the differences in materials, construction, craftsmanship, installation environments, and maintenance practices, battery strings from different manufacturers have many unique characteristics. Even the same types of batteries from the same manufacturers will see variances in performance and capacity from one string to another. There are many ways to predict the condition of a battery systems performance and remaining life expectancy, however, the IEEE capacity testing procedures are the only definitive proof of a battery systems ability to perform as specified by the battery manufacturer.

Nowadays, with the popularity of VRLA batteries, fewer indications are available to determine the condition of a battery.

We believe:

- a) The battery voltage in float charge operation and the batteries true capacity have no direct correlation.

As we know, batteries which have a low capacity can still display a normal voltage in float mode. Simple interpretation of available data is not accurate in determining if a battery will perform as required when called upon.

- b) Full rated capacity discharging is still the most accurate method to test the performance of batteries.

For systems which are created by a number of cells connected in series, the actual capacity of battery string relies on the ability of the worst cell to perform to capacity. The principle goal of capacity testing is to find these poorly-performing cells and replace them to increase the service life and reliability of the whole battery system. Applying a constant current as specified by the manufacturer for a specific period of time allows for monitoring the batteries’ voltage to ensure the cell remains above

the specified cut off voltage and allows us to determine the battery and systems actual performance capacity as a way of ensuring the systems' performance.

Examining a voltage drop curve for the discharge rates:

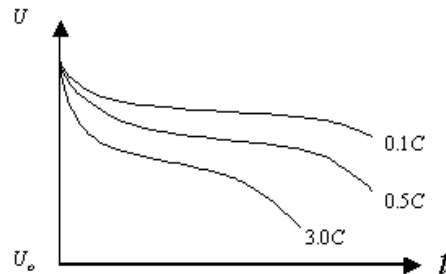

From the curves, we know what the performance is supposed to be at a given rate of discharge and this is the most uniform and accurate method for estimating the capacity of a battery.

3.2 Constant Current Principle

The internal circuitry of the SBS-8400 uses a PWM (pulse width modulation) control technique. Controlled by the CPU and sensing circuits, the power circuit can discharge the battery string with very accurate, automatically corrected control. Data collection and interpretation by the software is automatic and accurate.

4. Operating Instructions

4.1 Environment Requirement

The unit should only be used in environments that are free from dust and flammable or explosive gases. It should be properly ventilated to dissipate heat produced.

4.2 Panel Description

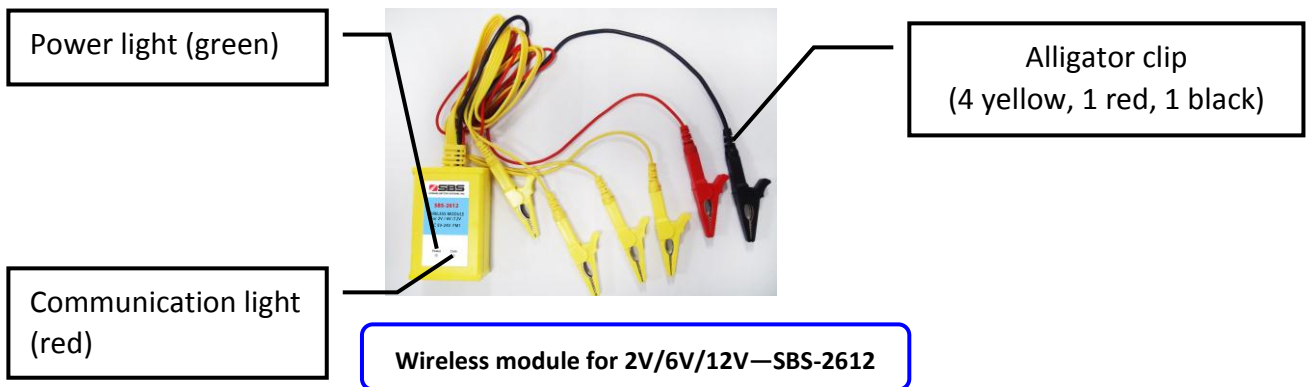
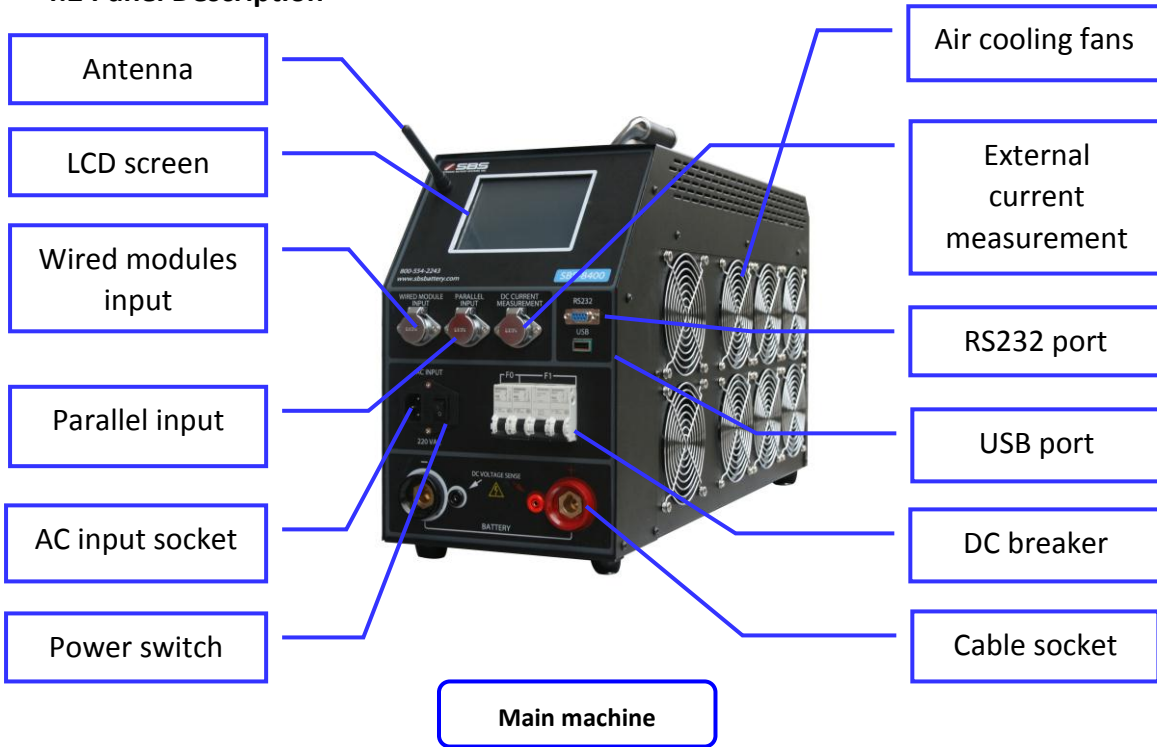

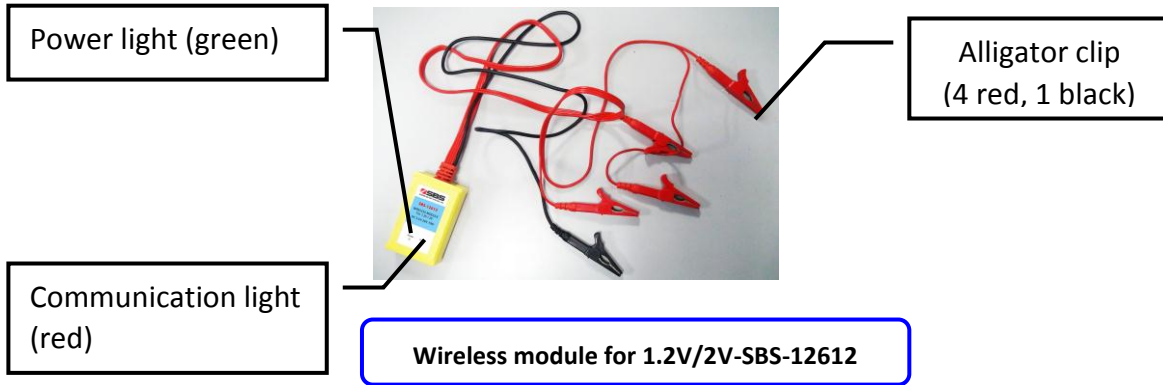

4.3 Main Machine Connections

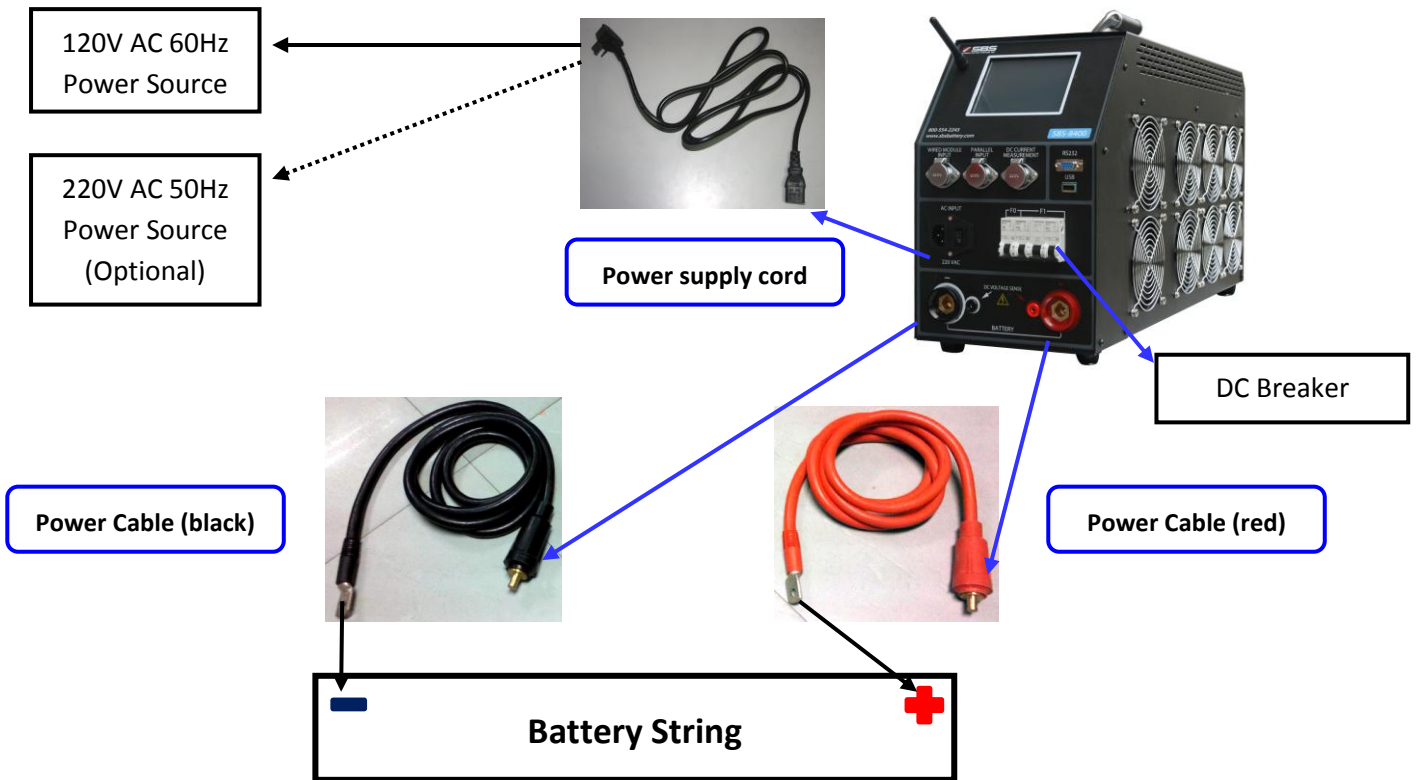

4.3.1 Use the power cables (1 red, 1 black) to connect the SBS-8400 to the battery string to be tested.

4.3.2 Use the power supply cord to provide the SBS-8400 with an AC power source.

- a) The SBS-8400 supports 120V AC 50Hz/60Hz external AC input power.
- b) If your power source is 220V AC 50Hz/60Hz, please use the optional 220V AC to 110V AC transformer to power the unit, or inform us when you plan to order a SBS-8400 and unit will be shipped to support 220V AC.

4.4 Wireless Modules Connections

Before connecting the wireless modules, please install the antenna.

Wiring Diagram

4.4.1 SBS-2612 wireless modules (for 2V) connections

SBS-2/6/12 Wireless Module

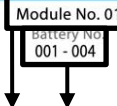
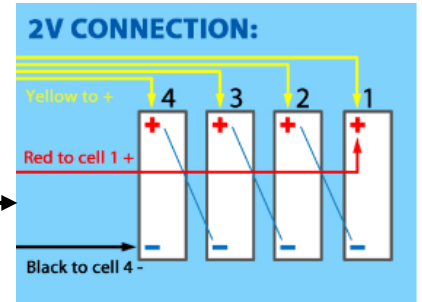
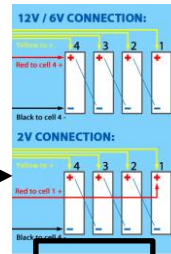
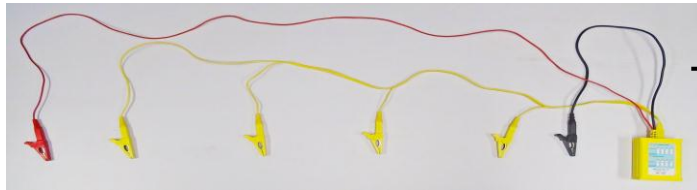

Wireless module number and the battery to connect
 For example: NO.1 module -- Connect to cells NO.1-NO.4 (from positive)
 NO.2 module -- Connect to cells NO.5-NO.8 (from positive)
 NO.3 module -- Connect to cells NO.9-NO.12 (from positive)

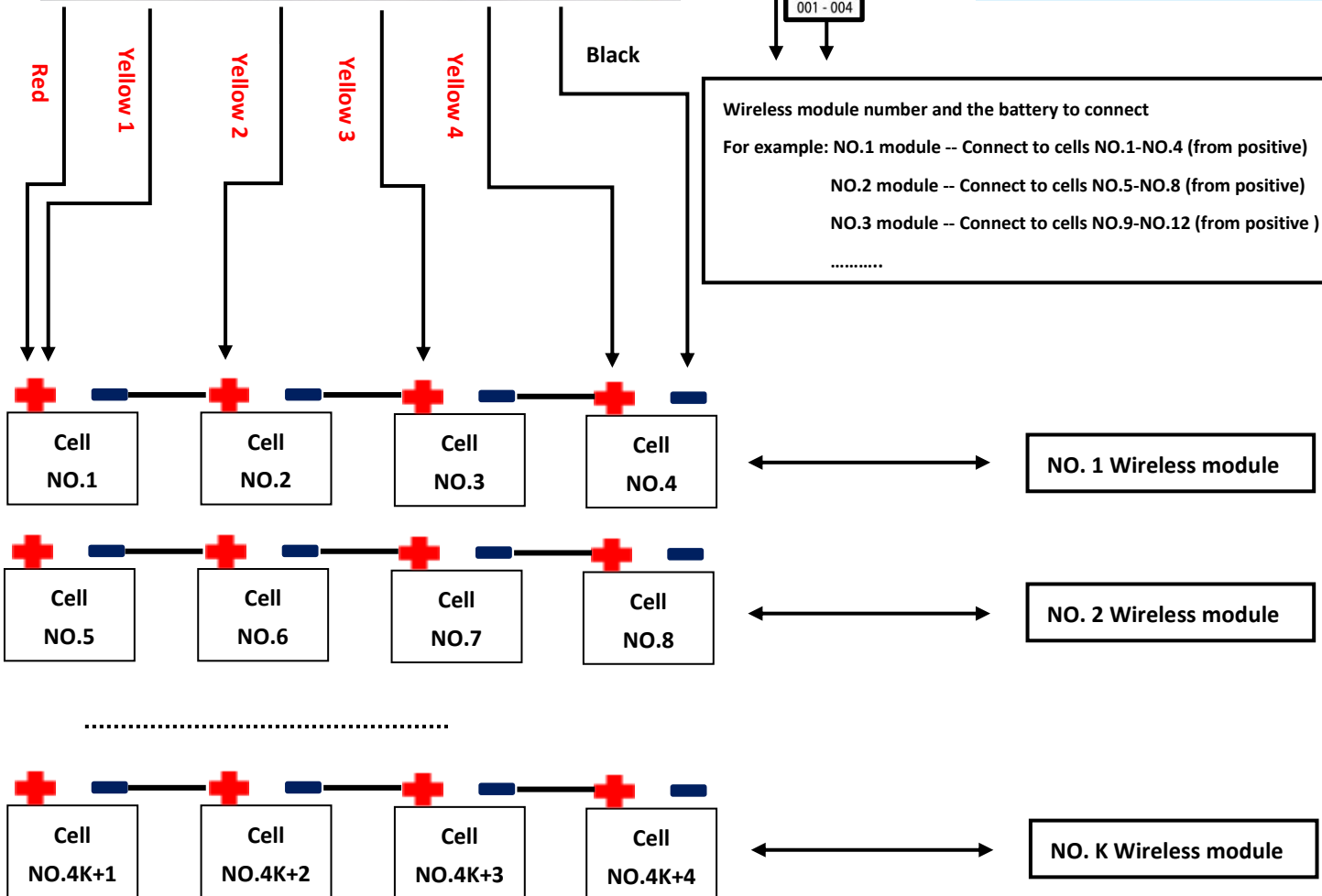

4.4.1.1 Reading the module number from the modules' labels, find the correct cells to connect the module to. **Do not connect the modules to 4 batteries which are not in series like No. 1, 5, 8, 9 - misconnection will likely damage the module immediately!**

4.4.1.2 Use the alligator clips (1 red, 1 black, 4 yellow) to connect modules to the batteries. Please follow the correct wiring rule "Yellow 1 to Yellow 4, from long to short. A wiring diagram is printed on the label of the modules for your reference.

4.4.2 SBS-2612 wireless modules (for 12V, 6V) connection

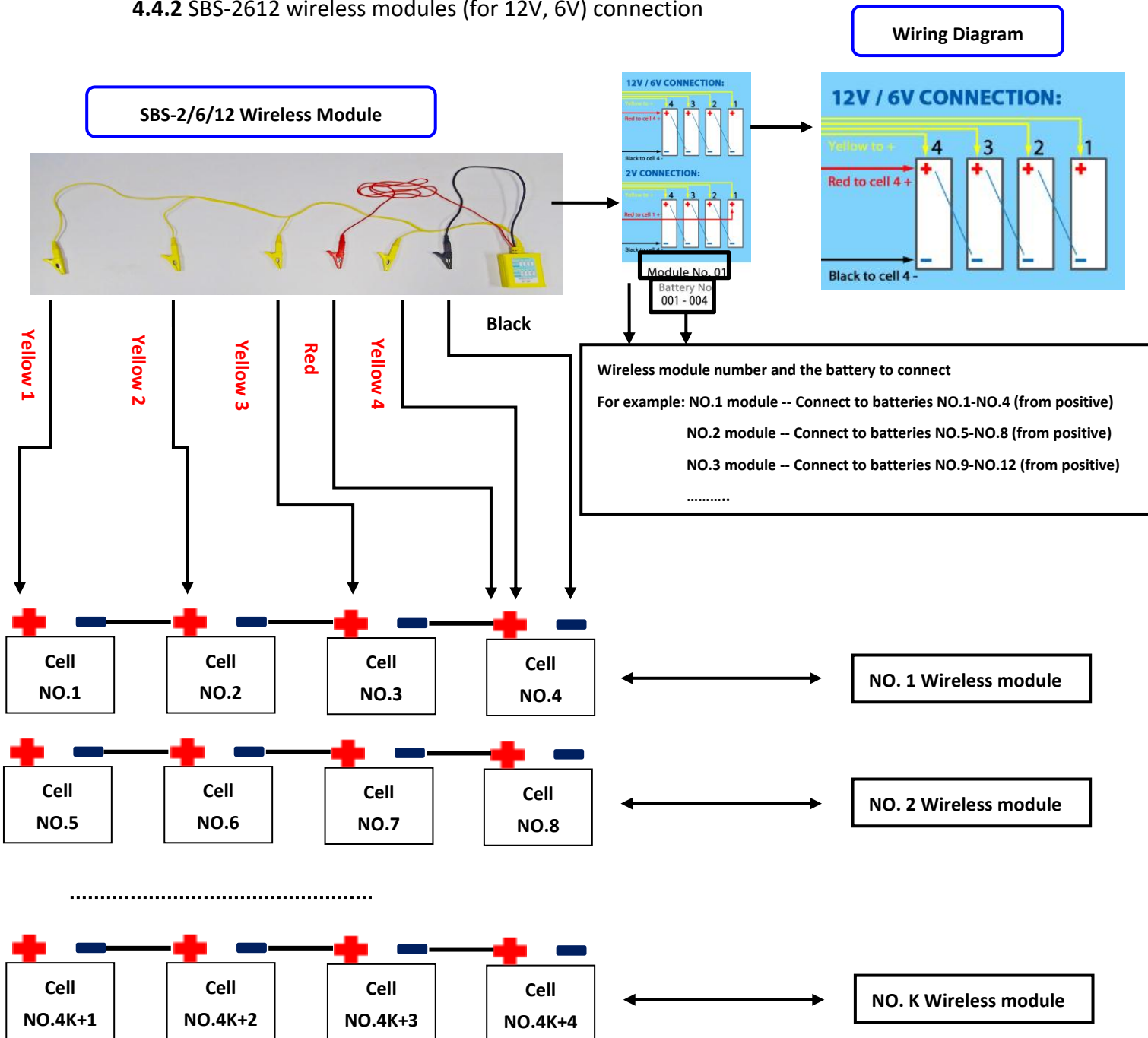

4.4.2. Read the module number from the label the modules, find the correct cells to connect the module to. **Do not connect the modules to 4 batteries which are not in series like NO.1,5,8,9, misconnection will likely damage the module immediately!**

4.4.2.1 Use the alligator clips (1 red, 1 black, 4 yellow) to connect modules to the batteries, please follow the correct wiring rule “Yellow 1 to Yellow 4, from long to short”, and the wiring diagram also print on the label of the modules.

4.4.3 SBS-1.2/2 wireless modules (for 1.2V, 2V) connection

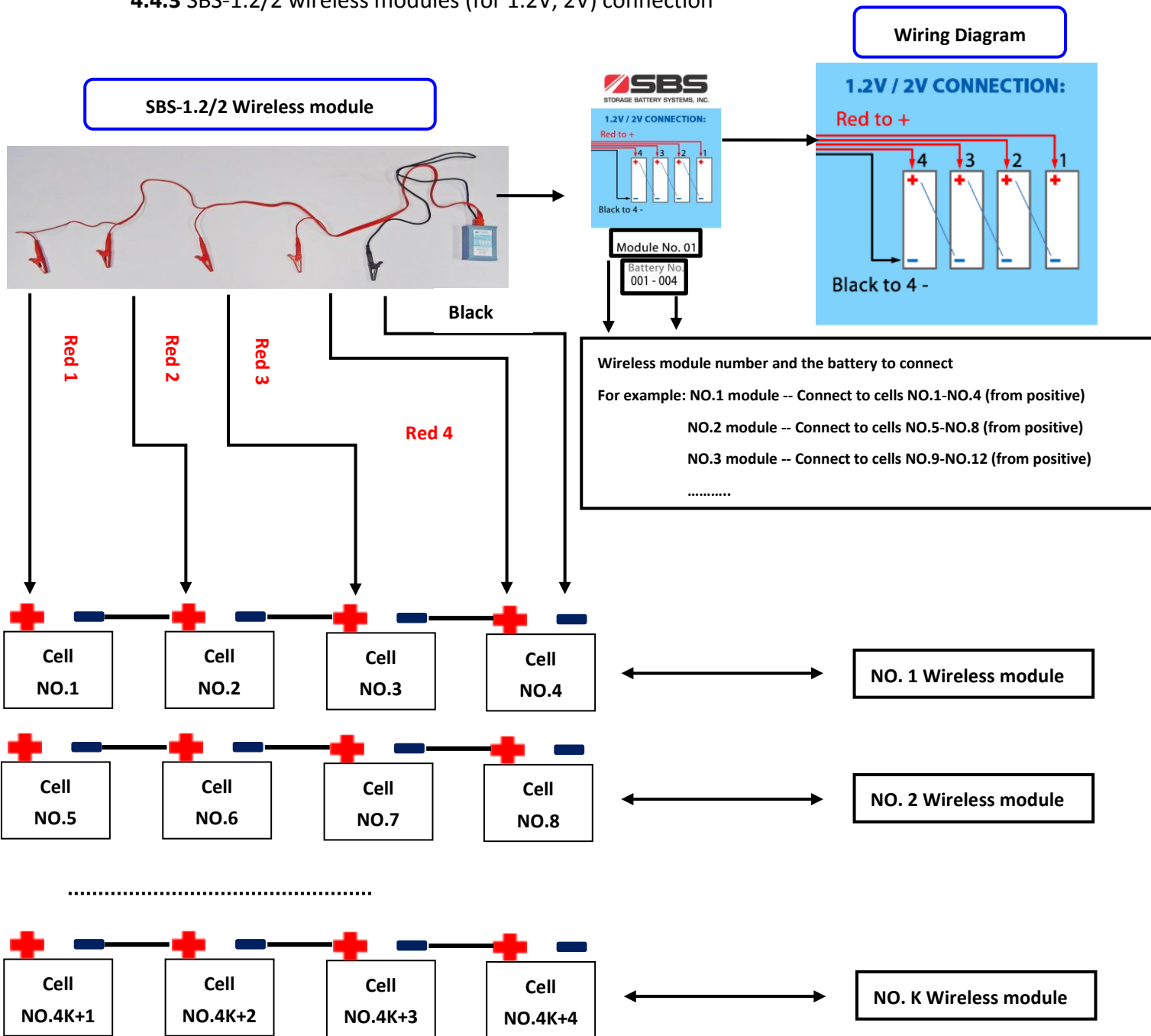

4.4.3.1 Read the module number from the label the modules, find the correct cells to connect the module to. **Do not connect the modules to 4 batteries which are not in series like NO. 1, 5, 8, 9 – the misconnection will likely damage the module immediately!**

4.4.3.2 Use the alligator clips (4 red, 1 black) to connect modules to the batteries, please follow the correct wiring rule “Red 1 to Red 4, from long to short”, and the wiring diagram printed on the label of the modules.

4.4.4 Connection guide when cell quantity is not a multiple of 4

4.4.4.1 SBS-2/6/12 wiring for last 4 to 1 cells

- 4 yellow wires, from left to right = from long to short
-  means this wire is not connected
- | separates the groups of cells

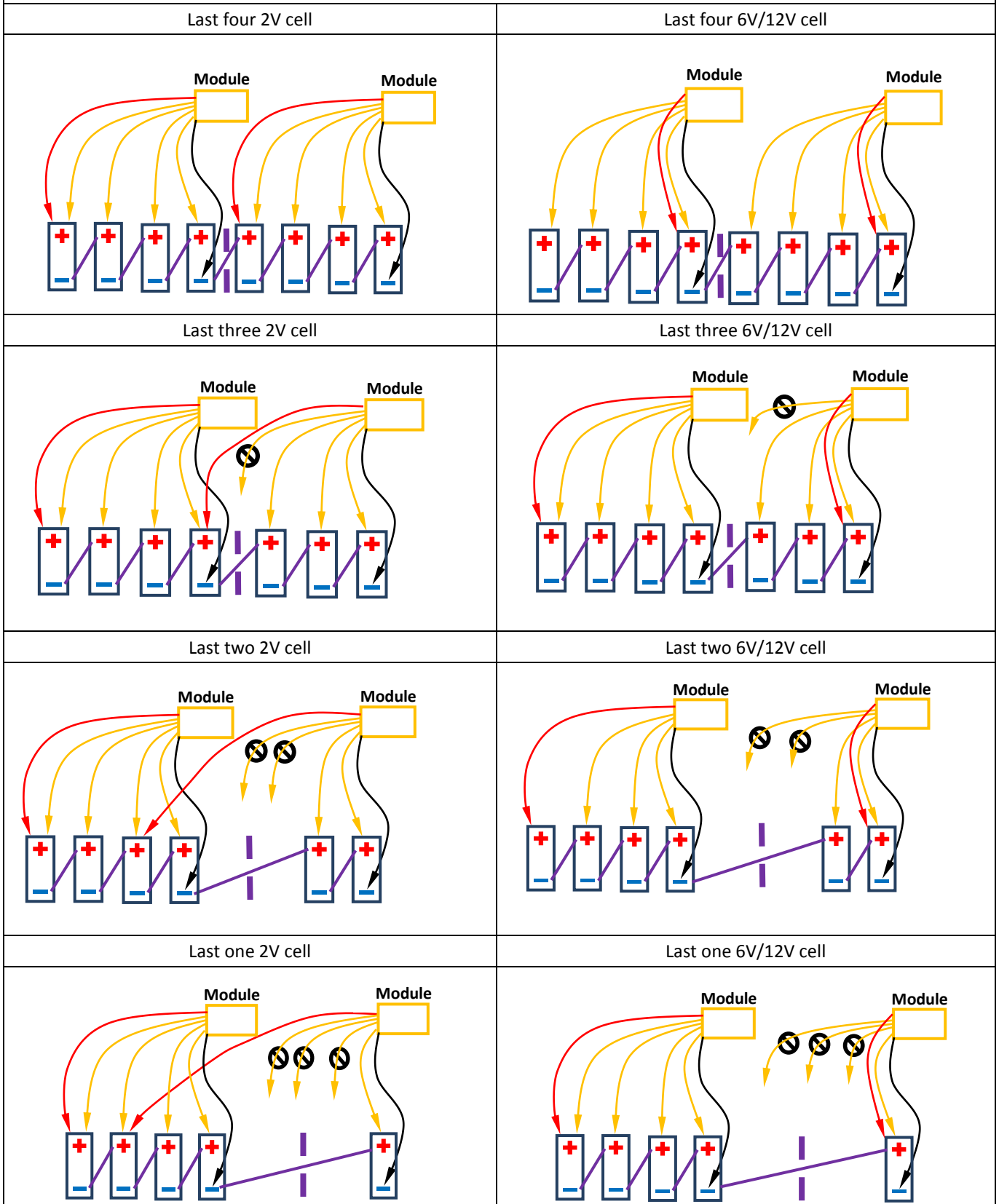

4.4.4.2 SBS-1.2/2 wiring for last 4 to 1 cells

- 4 red wires, from left to right = from long to short
- means this wire no need to connect
- separate the last cells with other cells

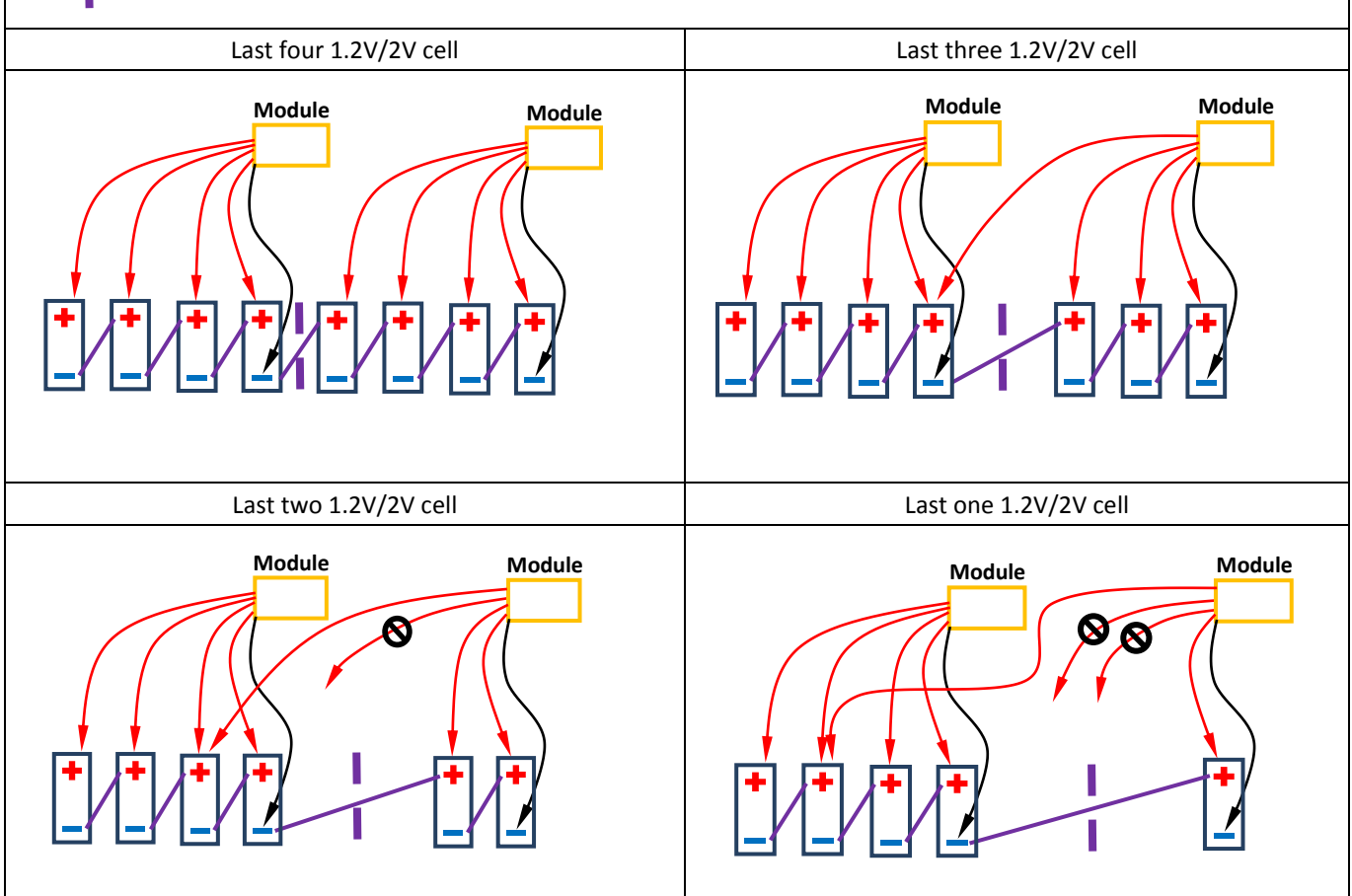

4.4.5 Spare modules and reassigning module numbers

4.4.5.1 No. 0 spare modules

With each module set you will find No. 0 spare modules. They have the following label: No number assigned. They can be addressed to any module No., and allow testing to continue if any assigned module should fail.

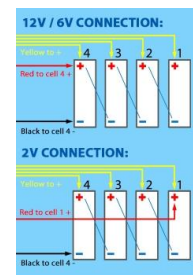

No. 0 Spare module label

Module No. ___
Battery No. ___

4.4.5.2 To Activate a No. 0 spare module:

When any assigned module fails (for example, No. 3 module), you can connect one of the spare

modules to 4 cells, just like a normal module. **Disconnect all other modules.** Re-address the spare module to No. 3 to replace the failed one by entering the 'Config Module Addr:' of the 'Setup' menu. Set '003#' and press 'config'. The spare module will become the new No. 3 module.

4.4.5.3 How to Erase and Reassign the Assigned Modules (Numbered)

If you run out of spare modules, and one of the assigned modules fails (for example, No. 3 module fails) you can erase No.15 and reassign to No. 3 for this urgent requirement.

- a) Open the No. 15 module box; you will see a small button on the PCB. (Yellow frame in the picture.)
- b) While holding this button down continuously, connect it with 4 cells, just like you would a normal module. It will power on, and then wait 10 seconds. Release the button.
- c) Check 'BatteryView' in LCD, if Cells 57- 60 (normally on No. 15 module) have no data, it means No. 15 module has been reset to a No. 0 spare one.
- d) Follow the procedure in '4.4.5.2 To Activate a No. 0 spare module', to edit it to No. 3.



4.5 Starting Up and Input Operation

4.5.1 After the SBS-8400 has been connected to the battery system, turn on the "AC" power switch.

4.5.2 A welcome interface will appear where you can see the unit identification. Press anywhere on the screen to go to the main menu. If 10 seconds elapse, the system will jump to the main menu automatically.

Power switch



4.5.3 SBS-8400 input method: touchpad directly on LCD screen.



The Welcome Screen



The Main Menu

4.6 Check the Connection of the Wireless Modules

4.6.1 Press "BatteryView" on the main menu to enter the table interface, if all wireless modules are connected correctly, you will see the voltage of each cell. If the voltages of some cells are not showing, please re-check the wireless module connections.

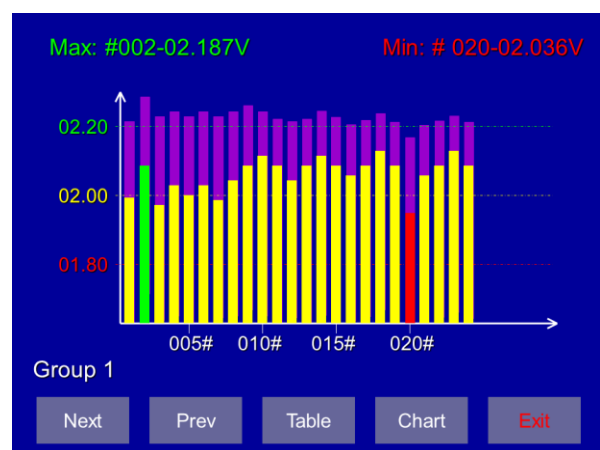
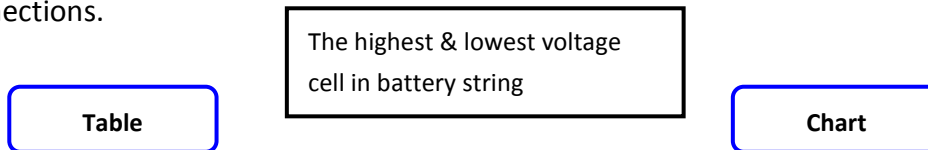

Each screen can show 24 cells.
For more than 24 cells, press "Next"
"Prev" to see the other pages.

Back to the main menu

4.6.2 Press "Chart" to see the histogram for each cell in the string.

4.6.3 Both the table and chart interfaces show 24 cells at a time. If the tested battery string has more than 24 cells, press the “Next” & “Prev” to see the other cells.

4.6.4 Press “Exit” to go back to the main menu

4.7 The Preset Function

4.7.1 The preset function allows 30 programmable locations to save discharge test setups. You can select any of the preset tests and press “Apply” to use those discharge parameters. **The SBS-8400 supports manual setting in the discharge interface without using the preset features.**

Press “Preset” on the main menu to enter the preset interface

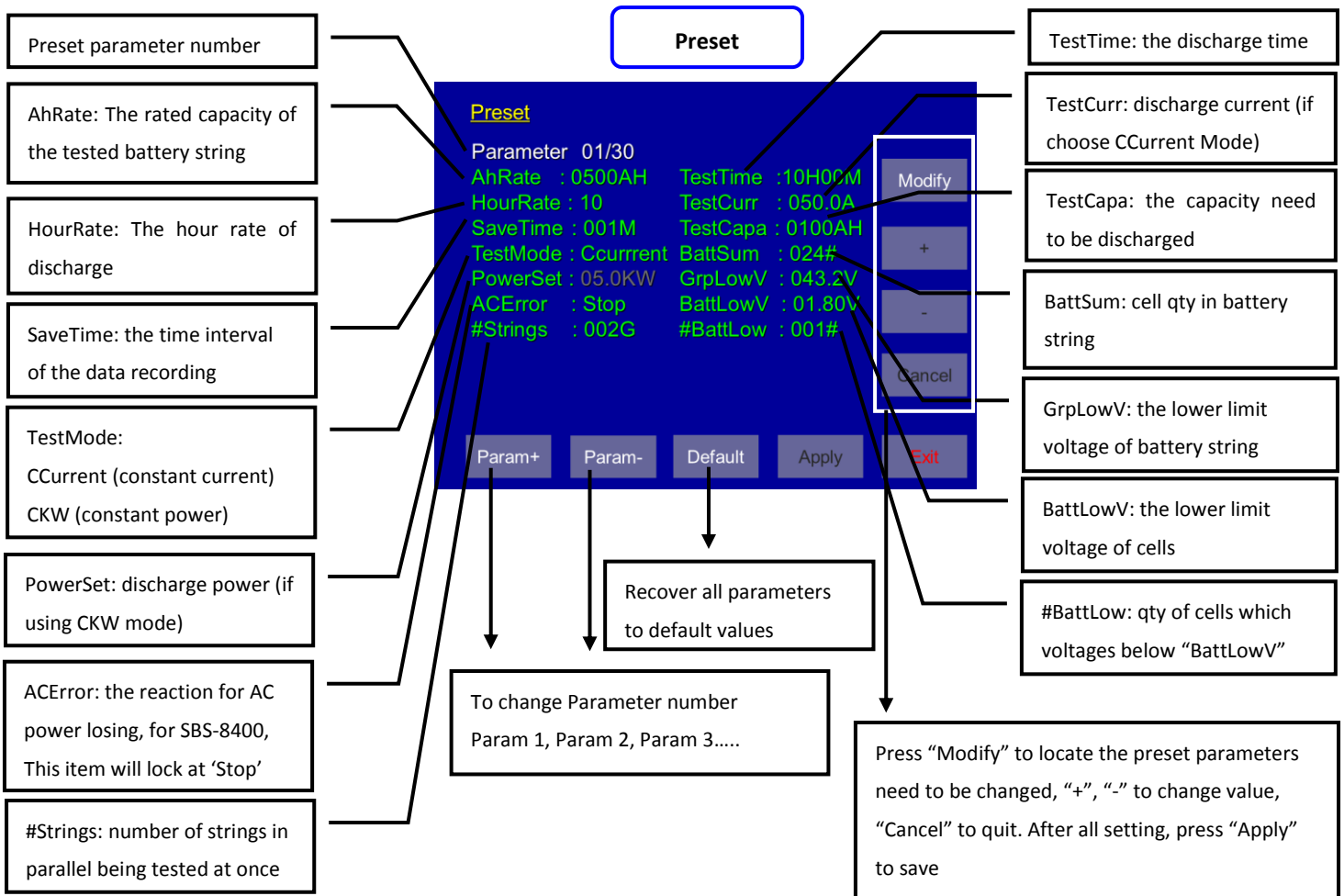

4.7.2 “TestCapa”, “TestTime”, “BattLowV”, “GrpLowV” are the test stop conditions, if any of these set-points is reached, the discharge will stop automatically.

4.7.3 For 1 battery string discharge, please keep “#Strings” at “001G”; if parallel discharging 2-4 strings is needed, 2-4 times the wireless modules will be needed. The discharge current will be ½ - ¼ for each string being tested.

4.7.4 If you want the discharge to stop when one bad cell reaches the “BattLowV”, please keep “#Battlow” in “001#”. If you want the discharging to stop when N bad cells reach the “BattLowV”, you can set the “#BattLow” to the number you need.

4.7.5 If you are not utilizing the wireless modules for the discharge, please set the “BattSum” to “000#”. “BattLowV” will be disabled from terminating the discharge.

4.8 Discharge

4.8.1 Press “Discharge” on the main menu to enter the discharge parameter interface.

4.8.2 In the parameter interface, you will see all the same parameters as in the “Preset”; you can re-edit the discharge parameters here and press “Apply” to save them.

4.8.3 Press “Start” on the discharge interface, and turn on the ‘F0’ breaker, if the battery string is connected correctly to the unit by power cables, you will see battery string voltage in ‘GroupVolt’.

4.8.4 Press “Start” again to start the discharge; LCD will show a Popup-window to ask you to verify if all fans are working. Then a popup-window again will ask you to turn on the ‘F1’ breaker. The test will begin automatically as soon as ‘F1’ is closed.

4.8.5 Manual stop the discharge: press “Pause” to pause the discharge, and press “Stop” to end the discharge, or press “Start” to continue the discharge.

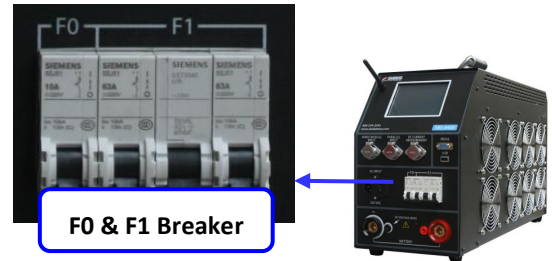

Parameter

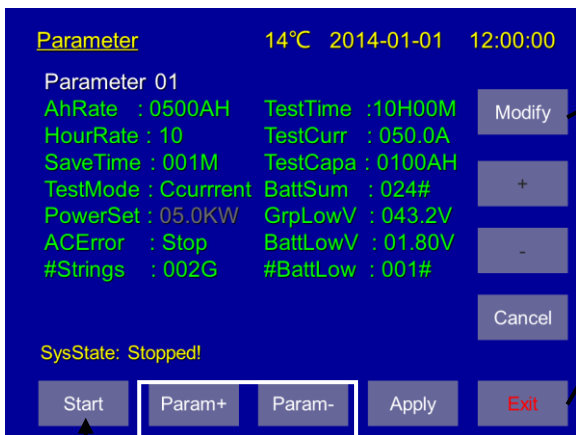

Press “Modify” to locate the preset parameters needed to be changed, “+”, “-” to change value, “Cancel” to quit. After desired values are entered, press “Apply” to save, and **the desired changes will be updated to “Preset”**

Back to the main menu



When the discharging starts, you can see the status in this screen, it includes:

- GroupVolt: the voltage of battery group
- Current: the discharge current
- TotalPower: the discharge power
- CapaSum: the total capacity discharged
- TestTime: the time since the discharge started
- #BattLow: the quantity of the batteries in which voltage is already below the “BattLowV” you set
- MaxBatt(V): the highest voltage battery in the group
- MinBatt(V): the lowest voltage battery in the group

To browse all cells’ voltages, “Table” & “Chart” screens are similar with the one in “BatteryView”

Change the parameters in the process of discharging; all changes can be activated immediately!

4.8.6 Press “Param” to adjust the parameters during the discharge (if necessary); all changes can be activated immediately and the discharge will not be stopped.

4.8.7 “SysState:” in the discharge interface will help you know the status of the discharge.

4.9 Download Data to PC

4.9.1 SBS-8400 provides two methods to record the test data:

- a) Use the RS232 cable to connect the unit with the PC. Through the analysis software real time test data can be displayed and downloaded during the test.
- b) Internal memory always saves all testing data; you can download the data via USB disk or RS232 cable to a PC.

4.9.2 Press “Data” in the main menu to enter the data interface

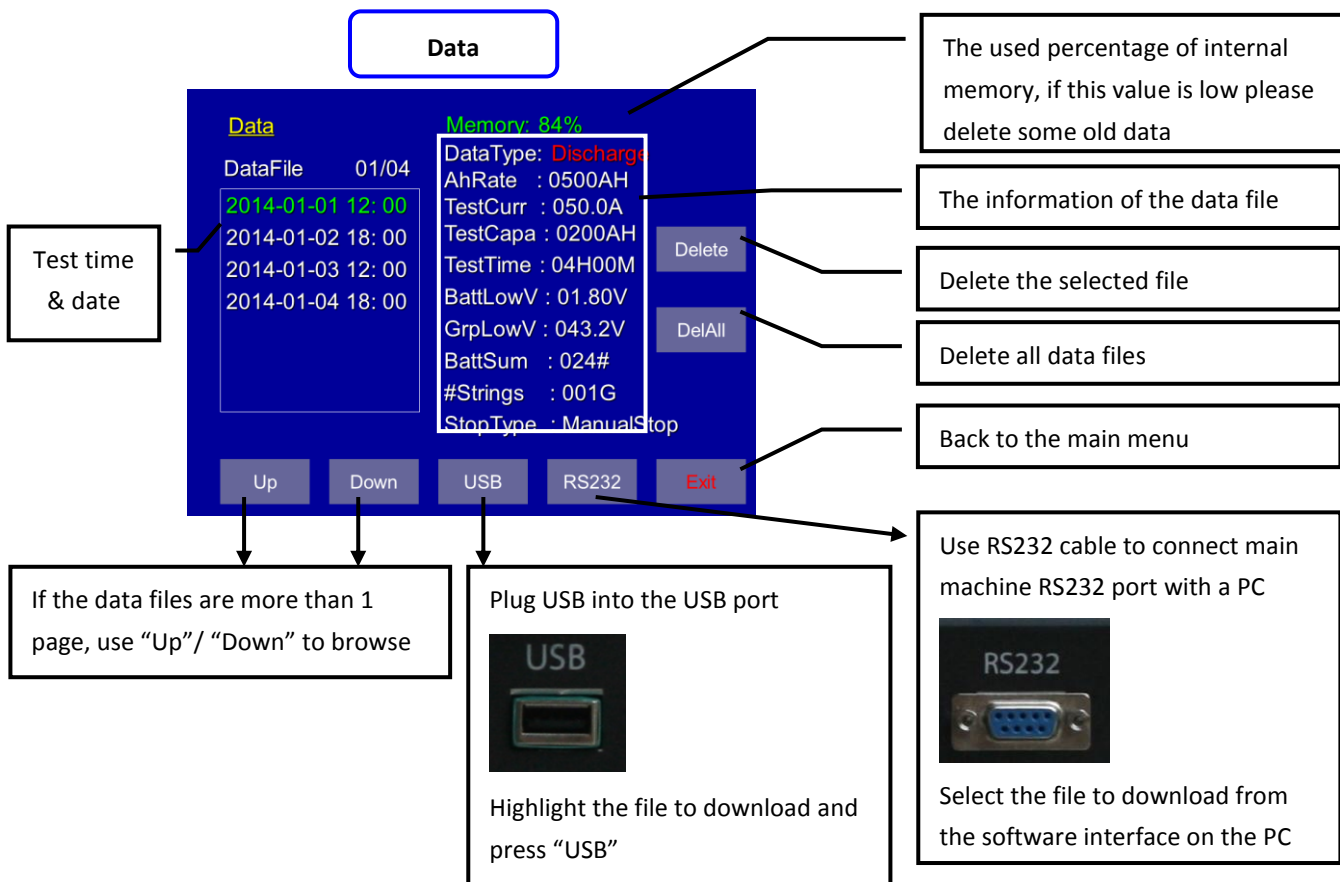

Data

The used percentage of internal memory, if this value is low please delete some old data

The information of the data file

Delete the selected file

Delete all data files

Back to the main menu

Test time & date

If the data files are more than 1 page, use “Up”/ “Down” to browse

Plug USB into the USB port



Highlight the file to download and press “USB”

Use RS232 cable to connect main machine RS232 port with a PC



Select the file to download from the software interface on the PC

4.10 System Setup

4.10.1 Press "Setup" in the main menu to enter the setup interface

The screenshot shows the 'Setup' interface with the following parameters and controls:

- System date & time:** Date: 2014-01-01, Time: 12:00:00
- InputType:** Touch
- BattLowAct:** Stop
- BattOrder:** Inc From Batt+
- ConfigModuleAddr:** 000#
- ModuleFreq:** 01FM
- Clamp range:** 200A
- Buttons:** Modify, +, -, Cal, Exit, Config

Callout boxes provide detailed instructions:

- InputType:** for SBS-8400, this item is locked at 'Touch'
- BattLowAct:** automatic operation when the number of "BattLowV" is over '#BattLow': Stop or Pause
- BattOrder:** wireless modules connecting reference, from the positive or negative main terminal
- Cal:** change Date to 2099-12-XX, 'Cal' button will be activated, for entering the 'Calibration' interface
- Modify:** Press "Modify" to locate the parameters need to be changed, "+", "-" to change value
- ConfigModuleAddr:** assign spare module to No. you need. Please follow '4.4.5.2 Activate No. 0 spare modules'
- ModuleFreq:** change frequency of wireless receiver for working with different frequency wireless modules
- Clamp range:** change the external current clamp range for different clamp type(100A/200A/600A)

4.10.2 'BattLowAct' allows control of what happens when the number of battery lows is reached. Failing cells can be jumped out and the test continued. Choose 'Pause', the discharge can then be continued when you adjust settings and 'Start' again, the whole process will be recorded as a single data file.

4.10.3 When cell No. of your battery string starts from negative electrode, please set 'BattOrder' to 'From Batt-'. SBS-8400 will reserve 4 cells sequence for each wireless module to keep your testing results correct.

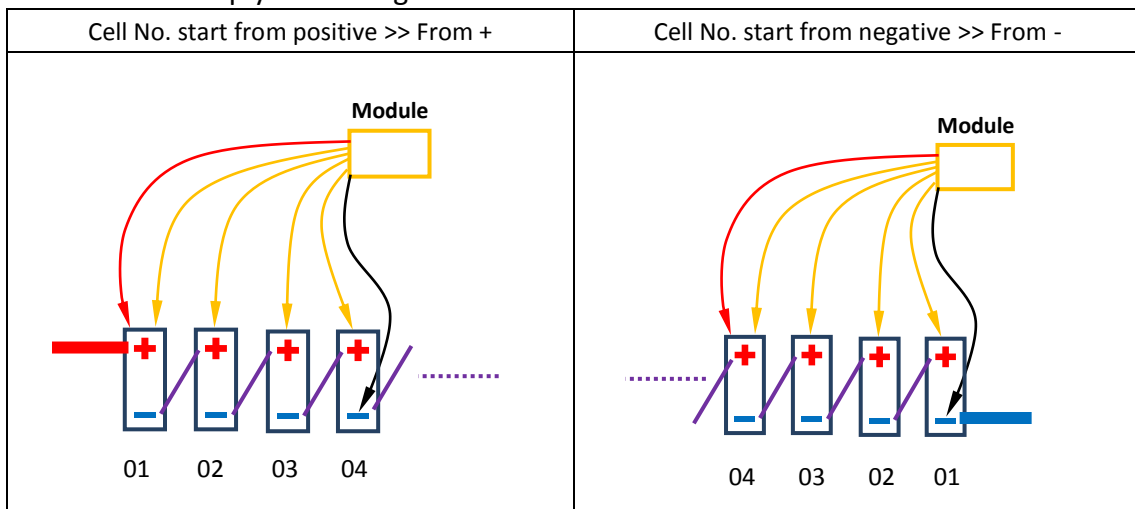

4.10.4 'ConfigModuleAddr': please follow '4.4.5.2 Activate No. 0 spare modules' for assigning a spare module to act as the one you need.

4.10.5 If two SBS-8400 units, with 2 sets of wireless modules, are testing different battery strings in same battery room, the modules will have an interference problem and will not be visible on both units. In this test application, the units will need 2 sets of wireless modules with different frequency settings. 'ModuleFreq' setting can be used to change the frequency of the SBS-8400 wireless receiver for working with different frequency wireless modules.

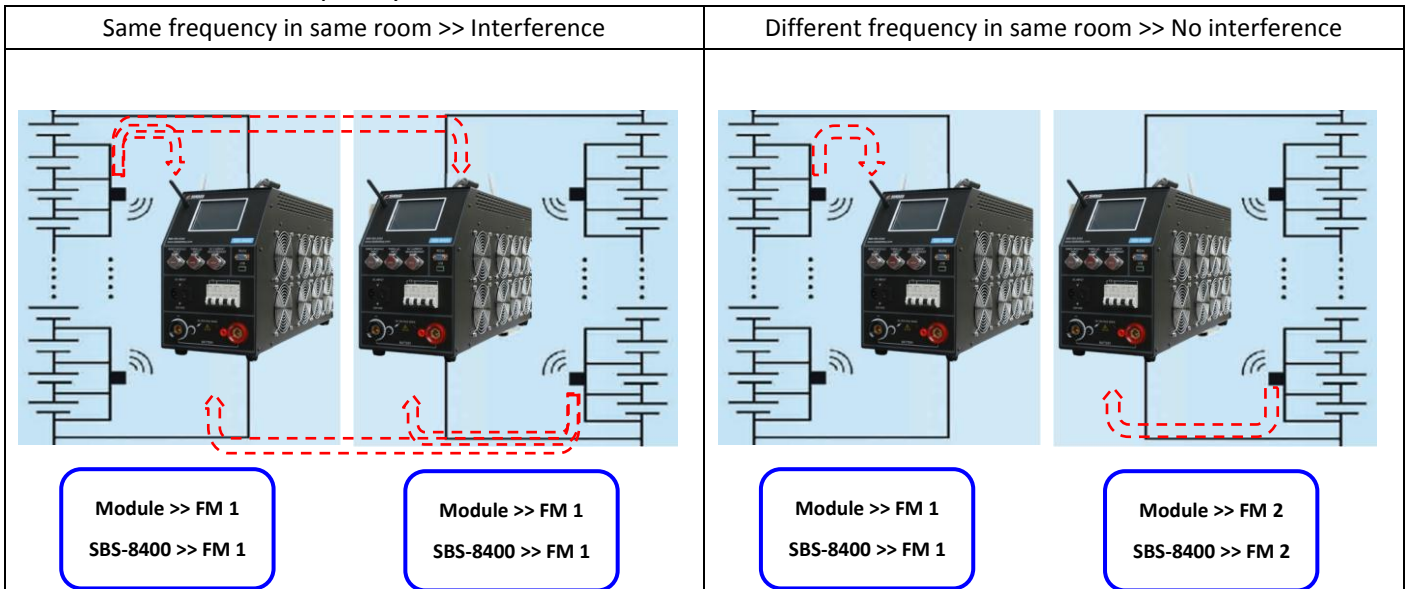

4.10.6 SBS-8400 can use three different ranges of external current clamps - 100/200/600A. Please select the correct clamp type when you connect an external clamp to the SBS-8400.

An external clamp is needed when:

- a) Two SBS-8400 or SBS-8400 + SBS-S load banks are operated in parallel; external clamp will measure the external unit current and add it to the primary SBS-8400.
- b) SBS-8400 is used in charge monitoring mode, the external clamp will measure current from charger to the battery string, and calculate the total Ah charged.



4.10.7 SBS-8400 provides a calibration function, if you have a high accuracy multi-meter and Ammeter, you can calibrate the unit by yourself. Change the date to 2099-12(year-month), the “Cal” button will be activated. Press “Cal” to enter the calibration interface.

Calibrate

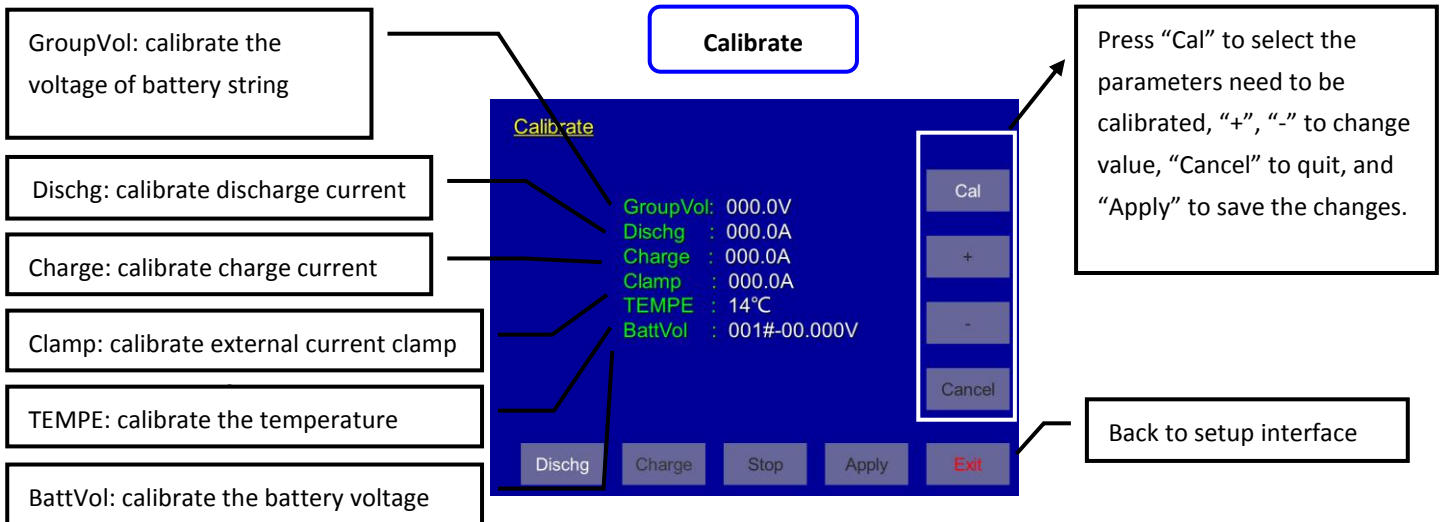

The screenshot shows the 'Calibrate' screen with the following parameters and controls:

- GroupVol:** 000.0V (calibrate the voltage of battery string)
- Dischg:** 000.0A (calibrate discharge current)
- Charge:** 000.0A (calibrate charge current)
- Clamp:** 000.0A (calibrate external current clamp)
- TEMPE:** 14°C (calibrate the temperature)
- BattVol:** 001#-00.000V (calibrate the battery voltage)
- Buttons:** Dischg, Charge, Stop, Apply, Exit (Back to setup interface)
- Right Panel:** Cal, +, -, Cancel

Callout text: Press “Cal” to select the parameters need to be calibrated, “+”, “-” to change value, “Cancel” to quit, and “Apply” to save the changes.

Function

4.11.1 Although the SBS-8400 can’t charge the battery string, it provides a charge monitoring function to record the charging process data.

4.11.2 Press “Charge” on the main menu to enter charge interface, and press “start” to record the charging process data.

Charge

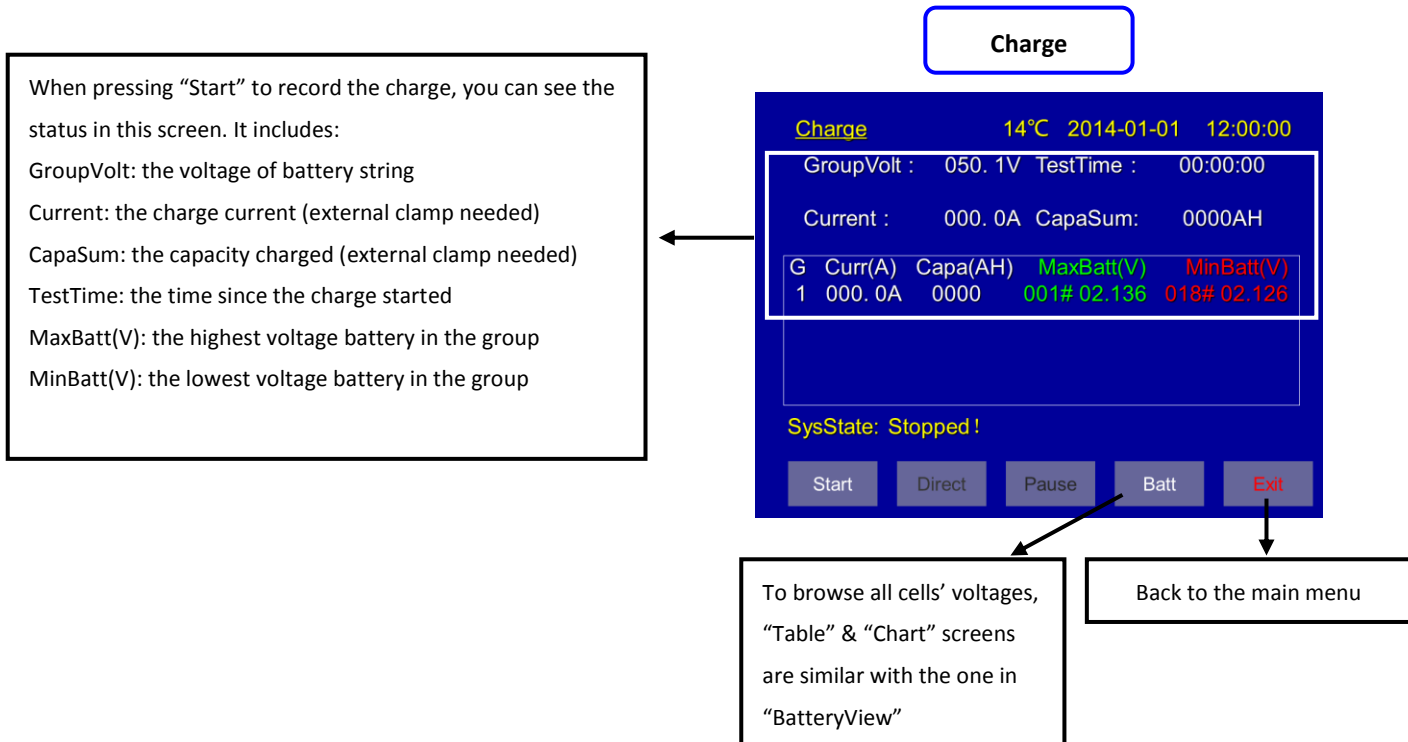

The screenshot shows the 'Charge' screen with the following data and controls:

- Header:** Charge, 14°C, 2014-01-01, 12:00:00
- GroupVolt:** 050.1V
- TestTime:** 00:00:00
- Current:** 000.0A
- CapaSum:** 0000AH
- Table:**

G	Curr(A)	Capa(AH)	MaxBatt(V)	MinBatt(V)
1	000.0A	0000	001# 02.136	018# 02.126
- SysState:** Stopped!
- Buttons:** Start, Direct, Pause, Batt, Exit

Callout text: When pressing “Start” to record the charge, you can see the status in this screen. It includes:
 GroupVolt: the voltage of battery string
 Current: the charge current (external clamp needed)
 CapaSum: the capacity charged (external clamp needed)
 TestTime: the time since the charge started
 MaxBatt(V): the highest voltage battery in the group
 MinBatt(V): the lowest voltage battery in the group

Callout text: To browse all cells’ voltages, “Table” & “Chart” screens are similar with the one in “BatteryView”

Callout text: Back to the main menu

4.12 Multiple Units in Parallel

4.12.1 SBS-8400 + SBS-S unit(s) in parallel

4.12.1.1 Connections

- Connect SBS-8400 & SBS-S unit(s) to battery string with power cables
- Connect external current clamp to the SBS-8400 – ‘DC CURRENT MEASUREMENT’ port, and put the clamp on the negative cable(s) from SBS-S unit(s) to battery string.
- Connect parallel control wire from SBS-8400 – ‘PARALLEL INPUT’ port to SBS-S – ‘EXTERNAL CONTROL’ port. (If there are 2 SBS-S units, please contact us to order the special control wire)

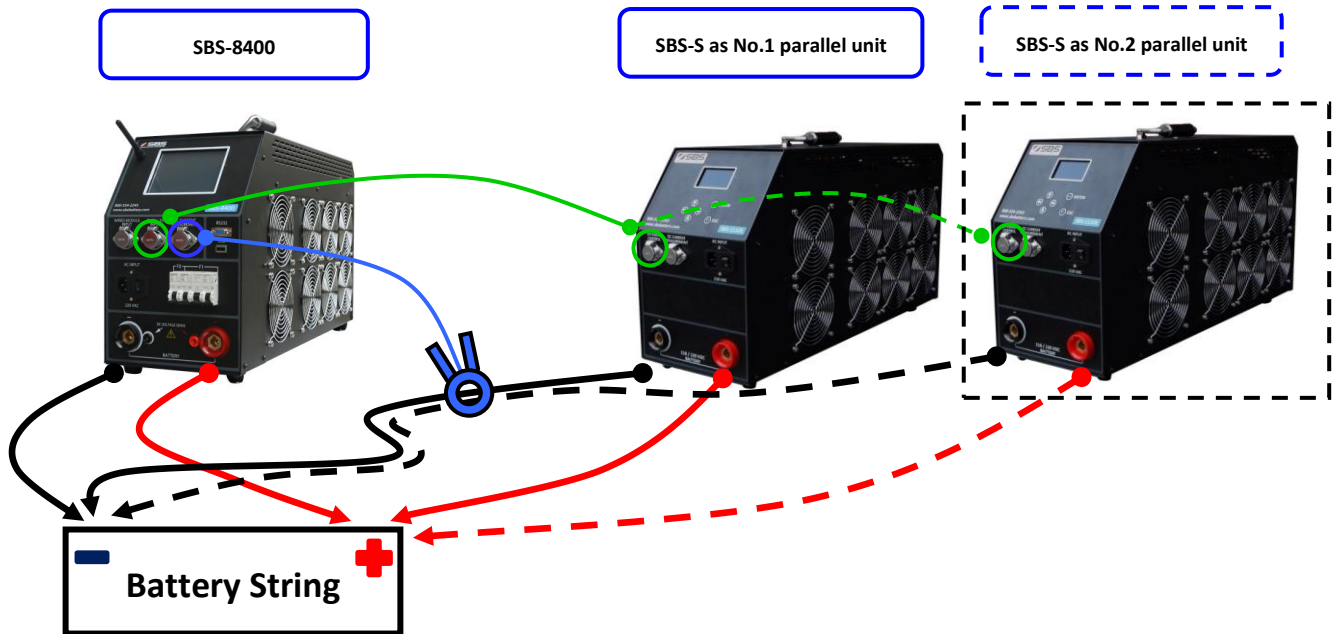

4.12.1.2 Setting

- Select the correct ‘Clamp range’ in SBS-8400 Setup interface
- Set all 4 stop thresholds and other details in SBS-8400 parameters interface, and set the total discharge current to ‘TestCurr’ you need (for example: 200A in total).
- Set all stop thresholds in SBS-S unit(s), and set current to the max value which SBS-S unit(s) is rated (example: set 100A in SBS-1110S).
- Save all setting in SBS-S unit(s) and leave LCD on the discharge screen.

DISCHARGE	STOPPED
VOLT: 123.5V	AMP: 000.0A
CAPACITY:	0000 AH
TEST TIME:	00:00:00

SBS-S unit discharge screen

4.12.1.3 Discharge

- Start discharge on the SBS-8400, and when the current increases to the max value the SBS-8400 can offer, it will send out control signal to SBS-S unit(s). SBS-S unit(s) will start discharging up to the settings value for total current.
- External clamp will add all discharge currents from SBS-S unit(s) to SBS-8400. And SBS-8400 will regulate the proper current to keep the total current set. (For example: 200A in total, if SBS-S offers 100A, SBS-8400 will offer 100A, if SBS-S offers 80A, SBS-8400 will offer 120A)

c) If any stop threshold is reached on the SBS-8400, all SBS-S unit(s) will receive a control signal to terminate the discharge at the same time.

4.12.2 Two SBS-8400 in parallel

4.12.2.1 Connections

- Connect SBS-8400(s) with battery string by power cables
- Connect external current clamp with master SBS-8400 – ‘DC CURRENT MEASUREMENT’ port, and put clamp on the negative cable from the parallel SBS-8400 to battery string.

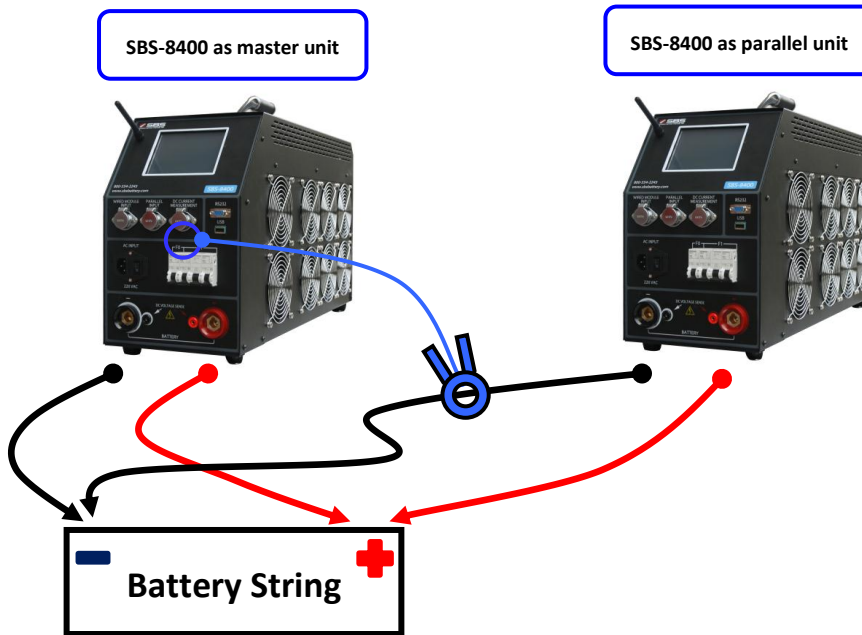

4.12.2.2 Setting

- Select the correct ‘clamp range’ in master SBS-8400 setup interface.
- Set all 4 stop thresholds and other parameters on both SBS-8400 parameter interfaces and set the total discharge current to ‘TestCurr’ on the master SBS-8400.
- Set ‘TestCurr’ to the max value that the parallel SBS-8400 can offer.

4.12.2.3 Discharge

- Start discharge on both SBS-8400 units; the parallel SBS-8400 will discharge the current on the unit.
- External clamp will add discharge current from parallel SBS-8400 to master SBS-8400. And master SBS-8400 will regulate the proper current to keep the total current set.

(For example: 200A in total, if parallel SBS-8400 offers 100A, master SBS-8400 will offer 100A, if parallel SBS-8400 offers 80A, master SBS-8400 will offer 120A)

- If any stop threshold is reached in master SBS-8400, the parallel SBS-8400 also has the same settings, so it will also terminate the discharge at the same time.

5. PC Software Instruction

5.1 Main Functions

- Recording real time discharge data by connecting the SBS-8400 with a PC.
- Read, display and save the downloaded USB data.
- Generate EXCEL test reports.

5.2 Install Analysis Software To PC

5.2.1 Install the software SBS-8400 Manager from the CD-ROM or USB disk.

5.2.2 Follow the screen prompts to finish the installation.

5.2.3 After the installation, you can click on the desktop icon to open the software.

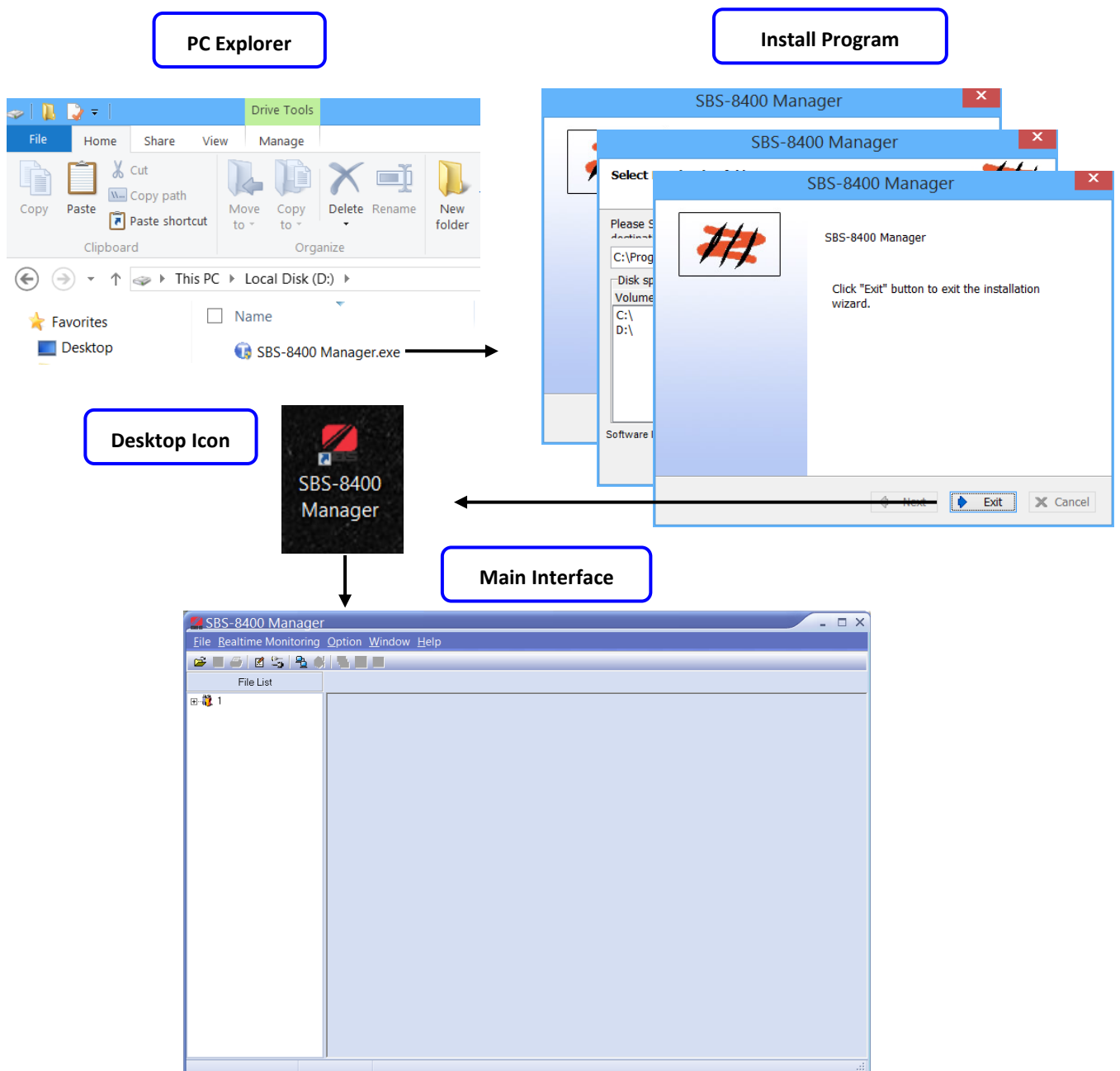

5.3 Real Time Recording During Testing

5.3.1 Use the RS232 connector to connect the SBS-8400 with a PC.

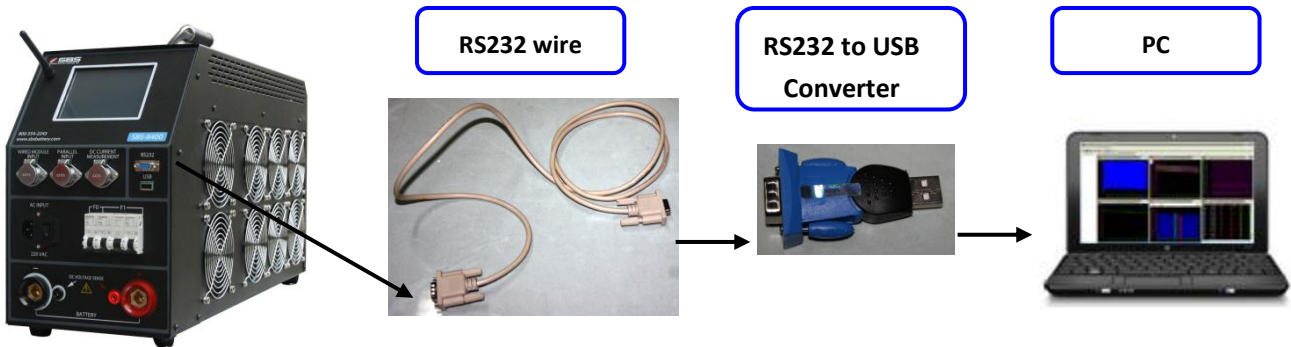

5.3.2 Choose “Connect” in the “Real time monitoring” menu to open the “Real-time Monitoring Link” interface.

The screenshot shows the 'SBS-8400 Manager' software with the 'Realtime Monitoring' menu open. The 'Connect' option is selected, leading to the 'Realtime Monitoring Setting' dialog box. The dialog box contains several sections:

- Test Unit Type:** SBS-8400
- Communication Port:** COM1 (selected)
- Number of Strings:** 1 (selected), with an 'In Parallel' checkbox.
- Data file setting:** A text area for file naming, with a 'Duplicate' checkbox and a 'Save' button.
- Battery Information:** A form with fields for Battery Model, Manufacturer, Type, Capacity, Current, Hour Rate, Voltage, etc. Some fields are highlighted in red.
- Buttons:** 'Connect' and 'Cancel' buttons at the bottom.

Explanatory callouts are provided for several key elements:

- Communication Port:** Choose the COM port number (you can find it in the Device Manager)
- Number of Strings:** the number of strings to be tested at the same time. (Usually it is 1)
- Save Data:** after filling in fields, press “Save” to create a “*.FGDF” file to save the real time data. If you test more than 1 string at a time, the option “Duplicate” can create multiple files for multiple string datas
- Battery Information:** input all information for the battery string (the red fields must be entered)
- Connect:** After saving the file, press “Connect” to enable recording real time data

5.3.3 Start the discharge on the SBS-8400, the real time data will begin showing in the PC software interface. Please input the red parameters correctly in the battery information screen as it can affect the result of capacity calculations.

5.3.4 The real time data can be saved simultaneously, even though you minimize the software in the process of discharging, the data file still is being recorded in the background as long as the software is running.

5.4 Download Data File to a USB Disk

5.4.1 Download the data file from the main machine, you can find the data file named "Fxxxxxxx.FBO". ("xxxxxx" is the time & date of data downloading.)

5.4.2 Double click the file to open the "Battery information" interface. Or you can open the software first and choose "Open file" in the "file" menu.

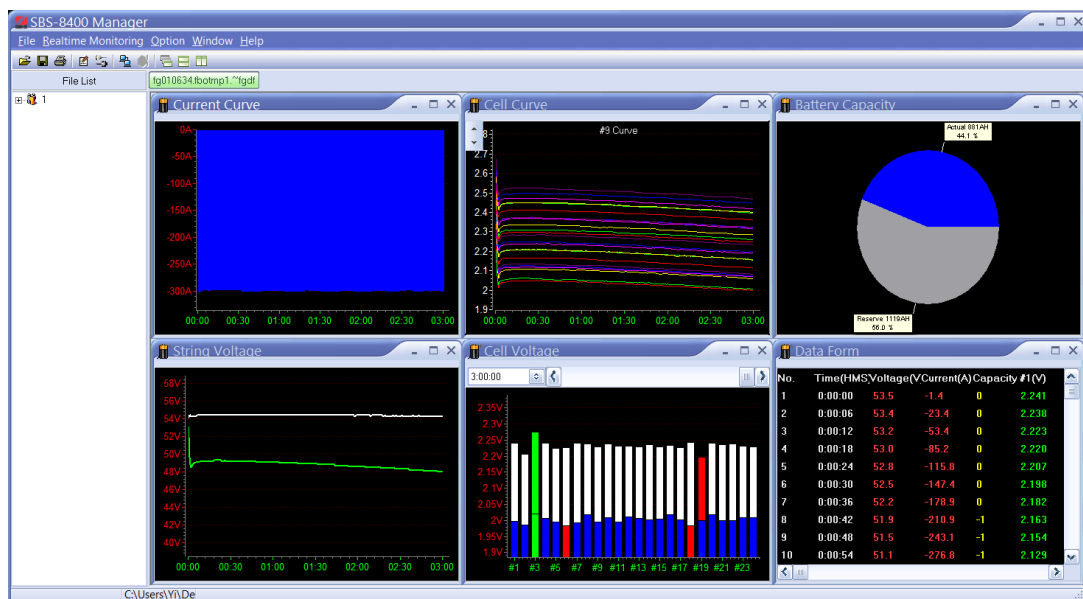
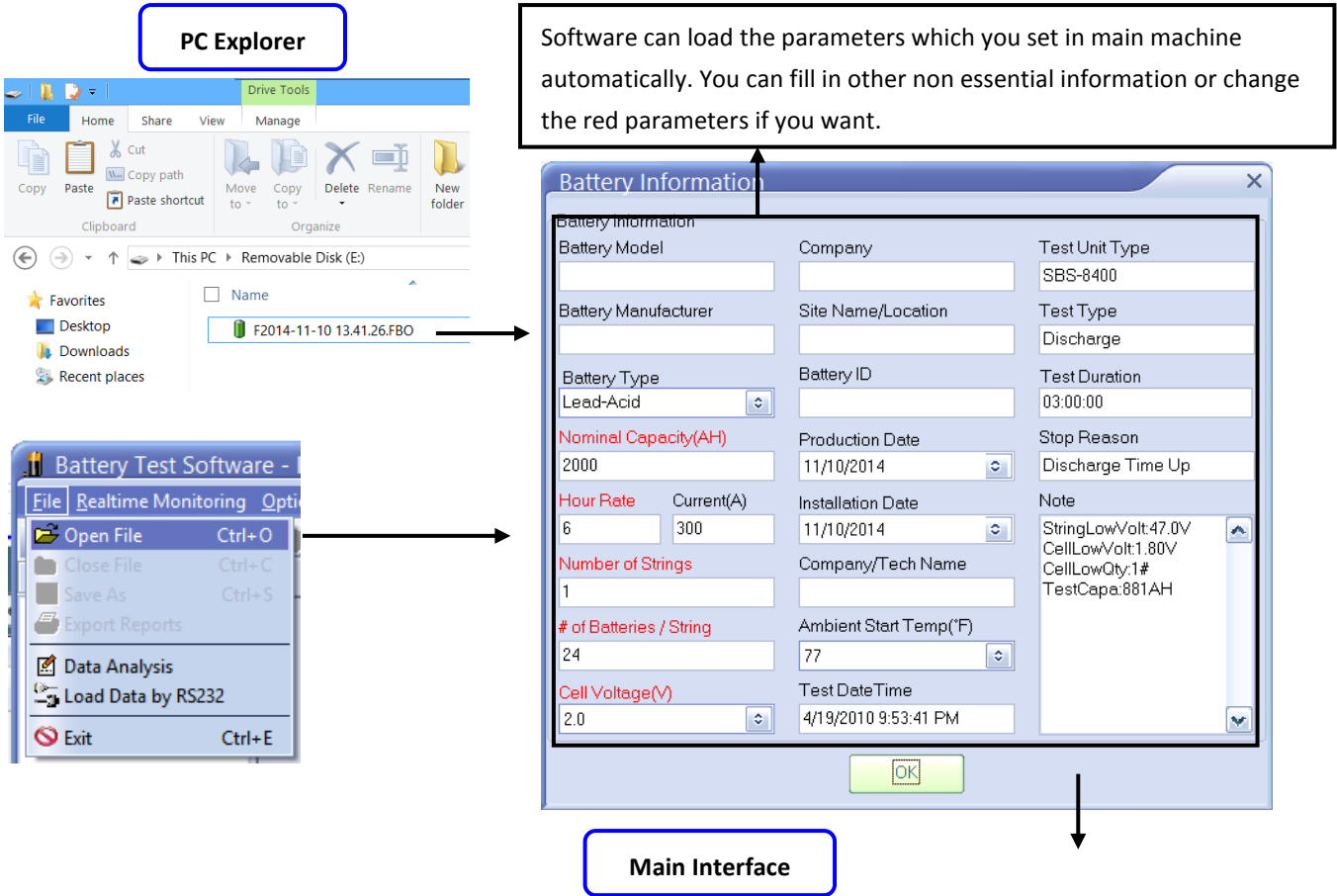

5.4.3 In the main interface, you will see 6 windows which show all necessary testing information:

- a) Total current curve: the current during the discharging (the value is negative during discharging and positive in charge monitoring mode).
- b) Cell curve: the voltage curve of each cell/battery can be added and deleted by a right click menu.

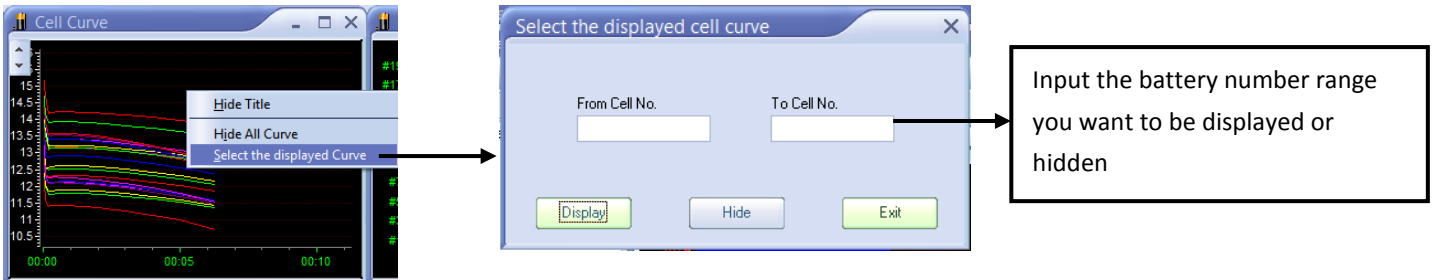

- c) Battery capacity: shows the actual capacity, reserve capacity and percentage of battery string
- d) Data form: shows the individual discharge data by time-interval during the discharge
- e) Cell voltage: each battery voltage can be displayed by bar chart. The bar chart can show you the initial and end voltages. Using the scroll bar on the top of this window, you can locate any time in testing to see the relevant result.



- f) Total voltage: the voltage curve of the battery string during discharge process.

5.5 Generate Excel Test Report

5.5.1 Press the  icon to generate a report, and in the “system information” window, it will show you the total pages in the report, choose “No” to generate an Excel report which includes all data information. If you don’t need a report with so many pages, press “Yes” to select a compression and generate an Excel report which has the number of pages you want.

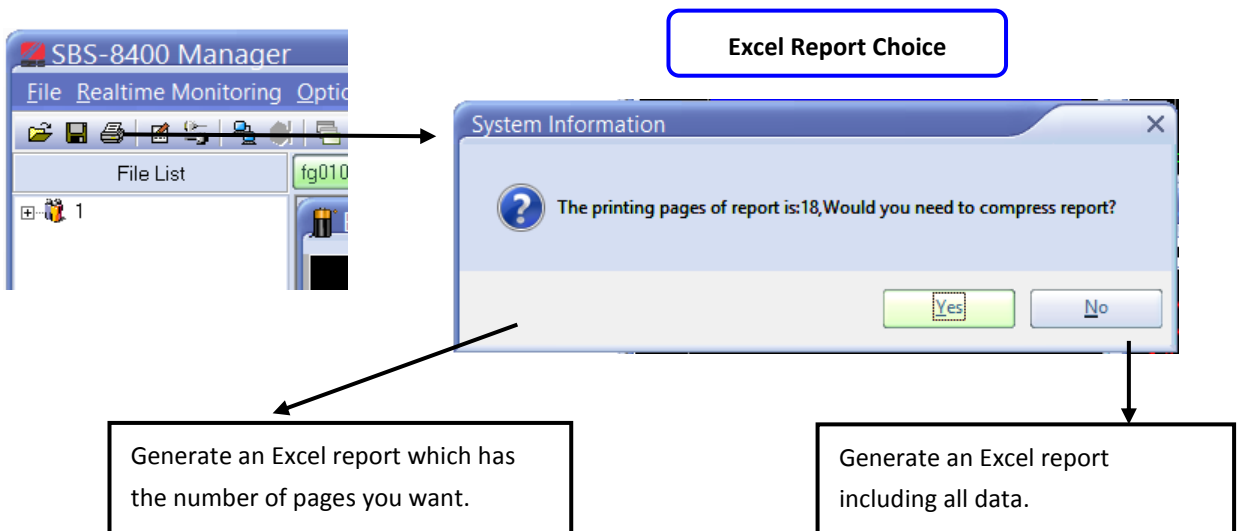

5.5.2 The “compress report” interface - input the number of pages you want, and press “compress report” to decrease the total page numbers and press “Export Report” to save the Excel report.

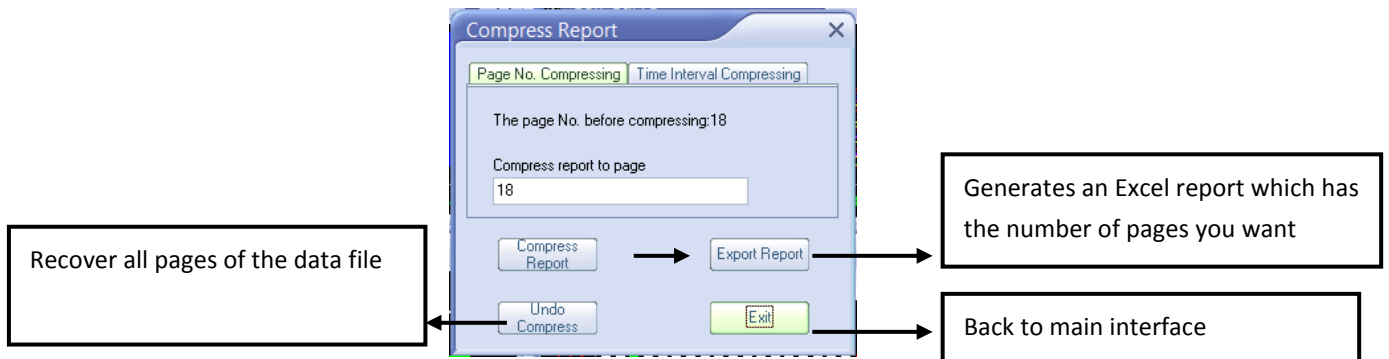

6. Precautions

6.1 For safety and ease of use, please read the complete manual before operation.

6.2 During testing, we suggest the operator stay in the vicinity of the testing unit.

6.3 Please check the specifications of the SBS-8400 to ensure the tested battery string is in the voltage range. If battery string voltage is out of the SBS-8400's test range, it could cause damage to the unit.

6.4 If you need to record the performance of each cell in the battery strings, wireless modules are required accessories. Without them, the PC analysis software can't collect the cell data to produce the voltage drop curves to analyze.

6.5 If an over temperature, over current, or an equipment failure occurs during the discharge, the warning alarm will activate automatically. Please turn off the DC breaker & AC input, to avoid a further possible damage to the equipment.

7. After-Sale Service

STORAGE BATTERY SYSTEMS, LLC

N56W16665 Ridgewood Dr.

Menomonee Falls WI 53051

Phone: (800) 554-2243

Fax: (262) 703-3073

Website: www.sbsbattery.com