

ES-747

FLOW COMPUTER



Proprietary Notice

The information contained in this publication is derived in part from proprietary and patent data. This information has been prepared for the expressed purpose of assisting operating and maintenance personnel in the efficient use of the instrument described herein. Publication of this information does not convey any rights to use or reproduce it or to use for any purpose other than in connection with the installation, operation and maintenance of the equipment described herein.

Copyright 1999
Printed in USA. All Rights Reserved.



WARNING!

This instrument contains electronic components that are susceptible to damage by static electricity. Proper handling* procedures must be observed during the removal, installation, or handling of internal circuit boards or devices.

*Handling Procedure

1. Power to unit must be removed.
2. Personnel must be grounded, via wrist strap or other safe, suitable means, before any printed circuit board or other internal device is installed, removed or adjusted.
3. Printed circuit boards must be transported in a conductive bag or other conductive container. Boards must not be removed from protective enclosure until the immediate time of installation. Removed boards must be placed immediately in protective container for transport, storage, or return to factory.

Comments

This instrument is not unique in its content of ESD (electrostatic discharge) sensitive components. Most modern electronic designs contain components that utilize metal oxide technology (NMOS, CMOS, etc.). Experience has proven that even small amounts of static electricity can damage or destroy these devices. Damaged components, even though they appear to function properly, may exhibit early failure.



SAFETY INSTRUCTIONS

The following instructions must be observed.

- This instrument was designed and is checked in accordance with regulations in force EN 60950 ("Safety of information technology equipment, including electrical business equipment").
A hazardous situation may occur if this instrument is not used for its intended purpose or is used incorrectly. Please note operating instructions provided in this manual.
- The instrument must be installed, operated and maintained by personnel who have been properly trained. Personnel must read and understand this manual prior to installation and operation of the instrument.
- This instrument is internally fused. Replace the internal fuse with the following specified type and rating only:

<u>Input Power</u>	<u>Recommended Fuse</u>
115 VAC	160 mA slow blow fuse
230 VAC	80 mA slow blow fuse
12-24 VDC	800 mA slow blow fuse

Disconnect power supply before replacing fuse!

- The manufacturer assumes no liability for damage caused by incorrect use of the instrument or for modifications or changes made to the instrument.

Symbols Used On Unit

<u>Number</u>	<u>Symbol</u>	<u>Publication</u>	<u>Description</u>
1	===	IEC 417, No. 5031	Direct current
2	□	IEC 417, No. 5172	Equipment protected throughout by DOUBLE INSULATION or REINFORCED INSULATION (equivalent to Class II of IEC 536—see annex H)
3	⚠	ISO 3864, No. B.3.1	Caution (refer to accompanying documents)

Technical Improvements

- The manufacturer reserves the right to modify technical data without prior notice.

CONTENTS

1. DESCRIPTION

1.1 Unit Description	1
1.2 Unit Features	1
1.3 Specifications	2

2. INSTALLATION

2.1 General Mounting Hints	6
2.2 Mounting Diagrams	6

3. APPLICATIONS

3.1 Liquid Volume	7
3.2 Corrected Liquid Volume	8
3.3 Liquid Mass	9
3.4 Batching	10
3.5 Corrected Gas Volume	11
3.6 Gas Mass	12

4. WIRING

4.1 Typical Batcher Wiring	13
4.2 Typical Rate/Total Wiring	13
4.3 Typical Thermistor Wiring	13
4.4 Wiring In Hazardous Areas	14

5. UNIT OPERATION

5.1 Front Panel Operation Concept for Run Mode	15
5.2 General Operation	16
5.3 Ratemeter/Totalizer Operation	16
5.3.1 Password Protection for Rate/Total mode	16
5.3.2 Relay Operation in Rate/Total mode	16
5.3.3 Pulse Output in Rate/Total mode	16
5.3.4 Analog Output in Rate/Total mode	16
5.3.5 RS-232 Serial Port Operation in Rate/Total mode	17
5.3.6 RS-485 Serial Port Operation in Rate/Total mode	17
5.4 Batcher Operation	18
5.4.1 Batcher Configuration	18
5.4.2 Password Protection for Batcher mode	19
5.4.3 Relay Operation in Batcher mode	19
5.4.4 Pulse Output in Batcher mode	19
5.4.5 Analog Output in Batcher mode	19
5.4.6 RS-232 Serial Port Operation in Batcher mode	20
5.4.7 RS-485 Serial Port Operation in Batcher mode	20

6. PROGRAMMING

6.1 Front Panel Operation Concept for Program Mode	21
6.2 Setup Menus	22
6.3 Setup Sub-Menus	23
6.3.1 INSTRUMENT TYPE	23
6.3.2 SELECT FLOW EQUATION	24
6.3.3 SETUP INDICATORS (Total)	24
6.3.4 SETUP INDICATORS (Density)	24
6.3.5 SETUP INDICATORS (Rate)	25
6.3.6 SETUP INDICATORS (Temperature)	25
6.3.7 SETUP INDICATORS (Pressure)	26
6.3.8 SETUP FLOW INPUT	27
6.3.9 SETUP AUX1 INPUT	29
6.3.10 SETUP AUX2 INPUT	30
6.3.11 SET FLUID PROPERTIES	31
6.3.12 SETUP PULSE OUTPUT	32
6.3.13 SETUP ANALOG OUTPUT	32
6.3.14 SETUP RELAYS	33
6.3.15 SETUP CONTROL INPUTS(RATE/TOTAL)	35
6.3.16 SETUP CONTROL INPUTS(BATCH)	35
6.3.17 SETUP REALTIME CLOCK(Time)	36
6.3.18 SETUP REALTIME CLOCK(Date)	36
6.3.19 SERIAL USAGE (RS-232/485)	37
6.3.20 SERIAL USAGE (Modem Options)	37
6.3.21 SET DATALOG/PRINT(Configure)	38
6.3.22 SET DATALOG/PRINT (Select_list)	39
6.3.23 ADMINISTRATIVE SETUP	39
6.3.24 SETUP NETWORK CARD	40

CONTENTS

7. PRINCIPLE OF OPERATION

7.1 General	41
7.2 Flow Equations	41
7.3 Calculating the Expansion Factor	44
7.4 Computation of Viscosity Coef. A and B	45
7.5 Linearization Table	46
7.5.1 Linearization Table General Information	46
7.5.2 Linearization Table for Pulse Inputs	46
7.5.3 Linearization Table Interpolation	46
7.6 Universal Viscosity Curve (UVC)	46
7.7 Strouhal Roshko Curve (StRo)	46

8. TEST, SERVICE and MAINTENANCE

8.1 Test Menus	47
8.2 Test Sub-Menus	48
8.2.1 Audit Trail	48
8.2.2 Error History	48
8.2.3 Print System Setup	48
8.2.4 Keypad test	49
8.2.5 Display test	49
8.2.6 Calibrate Aux1 0mA	50
8.2.7 Calibrate Aux1 20mA	50
8.2.8 Calibrate Aux2 0mA	51
8.2.9 Calibrate Aux2 20mA	51
8.2.10 Calibrate Thermistor: 100 Ohms	52
8.2.11 Calibrate Thermistor: Open	52
8.2.12 Calibrate Aux2 0V	53
8.2.13 Calibrate Aux2 10V	53
8.2.14 Calibrate 100 ohm RTD	53
8.2.15 Calibrate 4mA Out	54
8.2.16 Calibrate 20mA Out	54
8.2.17 Analog In Test	54
8.2.18 Pulse input test	55
8.2.19 Analog out test	55
8.2.20 Excitation out test	55
8.2.21 Pulse out test	56
8.2.22 Relay test	56
8.2.23 Control input test	56
8.2.24 Battery Voltage test	57
8.2.25 Data logger utility	57
8.3 Internal Fuse Replacement	58

9. RS-232 SERIAL PORT

9.1 RS-232 Serial Port Description	59
9.2 Instrument Setup by PC Over Serial Port	59
9.3 Operation of Serial Communication Port with Printers	59
9.4 ES-747 RS-232 Port Pinout	59

10. RS-485 SERIAL PORT

10.1 RS-485 Serial Port Description	60
10.2 General	60
10.3 Operation of Serial Communication Port with PC	60
10.4 ES-747 RS-485 Port Pinout	60

11. FLOW COMPUTER SETUP SOFTWARE

11.1 System Requirements	61
11.2 Cable and Wiring Requirements	61
11.3 Installation for Windows™3.1 or 3.11	61
11.4 Using the Flow Computer Setup Software	62
11.5 File Tab	62
11.6 Setup Tab	62
11.7 View Tab	63
11.8 Misc. Tab	63

12. GLOSSARY OF TERMS

12 Glossary Of Terms	64
----------------------------	----

13. DIAGNOSIS AND TROUBLESHOOTING

13.1 Response of ES-747 on Error or Alarm:	68
13.2 Diagnosis Flow Chart and Troubleshooting	69
13.3 Error & Warning Messages:	70
13.3.1 Sensor/Process Alarms	70
13.3.2 Self Test Alarms	71

APPENDIX A (Fluid Properties Table)	72
APPENDIX B (Setup Menus)	73

Unit Description

1. Description

1.1 Unit Description:

The ES-747 Flow Computer satisfies the instrument requirements for turbine and other pulse producing flowmeters in liquid and gas applications. Multiple flow equations and instrument functions are available in a single unit with many advanced features.

The alphanumeric display shows measured and calculated parameters in easy to understand format. Single key direct access to measurements and display scrolling is supported

The versatility of the ES-747 permits a wide measure of versatility within the instrument package. The various hardware inputs and outputs can be “soft” assigned to meet a variety of common application needs. The user “soft selects” the usage of each input/output while configuring the instrument.

The isolated analog output can be chosen to follow volume flow, corrected volume flow, mass flow, temperature, pressure or density by means of a menu selection. Most hardware features are assignable by this method.

The user can assign the standard RS-232 Serial Port for data recording, transaction printing, or for connection to a computer or modem.

Front panel selection of fluid type is supported. Up to 10 fluids can be stored in the unit

Linearization options include UVC, Strouhal/Roshko and 40 point linearization tables.

A Service or Test mode is provided to assist the user during start-up system check out by monitoring inputs and exercising outputs and printing system setup.

Unit Features

1.2 Unit Features:

The ES-747 Flow Computer offers the following features:

- Supports Turbine and Other Pulse Producing Flowmeters
- Menu Selectable Hardware & Software Features
- Two Line VFD or LCD Display
- Universal Viscosity Curve (UVC) and Strouhal/Roshko Advanced Linearization Methods
- Advanced Batching Features: Overrun Compensation, Print End of Batch
- Isolated Outputs (Pulse, Analog and Relay) Standard
- RS-232 Port Standard, RS-485 Optional
- Windows™ Setup Software
- Gas & Liquid Flow Equations
- DDE Server & HMI Software Available
- Selectable Fluids

1.3 Specifications:

Specifications:

Environmental

Indoor Use
 Altitude up to 2000m
 Operating Temperature: 0°C to +50°C
 (-20°C to 55°C optional)
 Storage Temperature: -40°C to +85 C
 Maximum Relative Humidity : 80% for temperatures
 up to 31°C decreasing linearly to 50% RH at
 40°C
 Mains supply voltage fluctuations not to exceed
 ±10% of the nominal voltage
 Transient overvoltage according to INSTALLATION
 CATEGORY II (see UL 3101-1 Annex J)
 POLLUTION DEGREE 2 in accordance with
 IEC 664 (see 3.7.3)
 Materials: UL, CSA, VDE approved

Listing: CE Light Industrial,
 UL File #: E192404

Display

Type: 2 lines of 20 characters, VFD or LCD
 Character Size: 0.3" nominal
 User selectable label descriptors and units of
 measure

Keypad

Keypad Type: Membrane Keypad
 Keypad Rating: Sealed to Nema 4
 Number of keys: 16

Enclosure

Size: See Dimensions
 Depth behind panel: 6.5" including mating connector
 Type: DIN
 Materials: Plastic, UL94V-0, Flame retardant
 Bezel: Textured per matt finish
 Equipment Labels: Model, safety, and user wiring

Power Input

The factory equipped power option is internally
 fused. An internal line to line filter capacitor is
 provided for added transient suppression.
 Order Option 1: 110VAC: 85 to 127 Vrms, 50/60
 Hz
 Order Option 2: 220VAC: 170 to 276 Vrms, 50/60
 Hz
 Order Option 3: 12VDC: 10.5 to 14 VDC
 Order Option 4: 24VDC: 18 to 24 VDC

Flow Inputs:

Pulse Inputs:

Number of Flow Inputs: one
 Configurations supported: single input or
 quadrature (menu selectable)
 Input Impedance: 10 KΩ nominal
 Pullup Resistance: 10 KΩ to 5 VDC (menu
 selectable)
 Pull Down Resistance: 10 KΩ to common
 Trigger Level: (menu selectable)
 High Level Input
 Logic On: 3 to 30 VDC
 Logic Off: 0 to 1 VDC
 Low Level Input (mag pickup)
 Selectable sensitivity: 10 mV & 100 mV
 Minimum Count Speed: Selectable: 1 - 99 secs
 Maximum Count Speed: Selectable: 40, 3k, 20kHz
 Overvoltage Protection: 50 VDC
 Fast Transient: Protected to 500 VDC
 (Capacitive Clamp)

Auxilliary/Compensation Inputs

The compensation inputs are menu selectable for
 temperature, pressure, density or not used.

Operation: Ratiometric
 Accuracy: 0.01% FS
 Thermal Drift: Less than 100 ppm/C
 Basic Measurement Resolution: 16 bit
 Update Rate: 1 update/sec minimum
 Automatic Fault detection:
 Signal Over-range/under-range
 Current Loop Broken
 RTD short
 RTD open
 Fault mode to user defined default settings
 Transient Protection: 500 V (Capacitive Clamp)
 Reverse Polarity: No ill effects
 Over-Voltage Limit (Voltage Input): 50 VDC

Available Input Ranges

Voltage: 0-10 VDC, 0-5 VDC, 1-5 VDC
 Current: 4-20 mA, 0-20 mA
 Resistance: 100 Ohms DIN RTD or
 Proprietary Thermistor - YSI55016

100 Ohm DIN RTD (DIN 42-760, BS 1904):

Three Wire Lead Compensation
 Internal RTD linearization learns ice point
 resistance
 1 mA Excitation current with reverse polarity
 protection
 Temperature Resolution: 0.01 C

Control Inputs

Switch Inputs are menu selectable for Start, Stop,
 Reset, Lock, Inhibit, Alarm Acknowledge, Print or
 Not Used.

Control Input Specifications

Input Scan Rate: 10 scans per second
 Logic 1: 4 - 30 VDC
 Logic 0: 0 - 0.8 VDC
 Transient Suppression: 500 V fast transient
 (Capacitive Clamp)
 Input Impedance: 100 KΩ
 Control Activation: Positive Edge or Pos. Level
 based on product definition

Excitation Voltage

110/220 VAC Powered Units
 Menu Selectable: 5, 12 or 24 VDC @ 100mA
 24 VDC Powered Units
 Menu Selectable: 5 or 12 VDC @ 100mA
 12 VDC Powered Units
 5 VDC @ 100mA

Fuse

Internal self resetting fuse supplied

Relay Outputs

The relay outputs are menu assignable to
 (Individually for each relay) Low Rate Alarm, Hi
 Rate Alarm, Prewarn Alarm, Preset Alarm,
 Temperature, Pressure, Density, Pulse Output
 (pulse options) or General purpose warning
 (security).

Number of relays: 2 (4 optional)
 Contact Style: Form C contacts
 Contact Ratings: 250 VAC @ 5 amps
 30 VDC @ 5 amps
 Fast Transient Threshold: 1000 V

Serial Communication

The serial port can be used for printing, datalogging, modem connection and communication with a computer.

RS-232:

Device ID: 01-99

Baud Rates: 300, 600, 1200, 2400, 4800, 9600, 19200

Parity: None, Odd, Even

Handshaking: None, Software, Hardware

Print Setup: Configurable print list and formatting

RS-485 (optional):

Device ID: 01-247

Baud Rates: 2400, 4800, 9600, 19200

Parity: None, Odd, Even

Protocol: Modbus RTU (Half Duplex)

Analog Output

The analog output is menu assignable to correspond to the Uncompensated Volume Rate, Corrected Volume Rate, Mass Rate, Temperature, Pressure, Density, Volume Total, Corrected Volume Total or Mass Total.

Type: Isolated Current Sourcing (on AC units)

Isolated I/P/C: 500 V

Available Ranges: 4-20 mA, 0-20 mA

Resolution: 12 bit

Accuracy: 0.05% FS at 20 Degrees C

Update Rate: 1 update/sec minimum

Temperature Drift: Less than 200 ppm/C

Maximum Load: 1000 ohms (at nominal line voltage)

Compliance Effect: Less than .05% Span

60 Hz rejection: 40 dB minimum

EMI: No effect at 3 V/M

Calibration: Operator assisted Learn Mode

Averaging: User entry of DSP Averaging constant to cause a smooth control action.

Isolated Pulse output

The isolated pulse output is menu assignable to Uncompensated Volume Total, Compensated Volume Total or Mass Total.

Isolation I/O/P: 500 V

Pulse Output Form: Open Collector

Maximum On Current: 125 mA

Maximum Off Voltage: 30 VDC

Saturation Voltage: 1.0 VDC

Maximum Off Current: 0.1 mA

Pulse Duration: User selectable: 10 or 100 mSec

Pulse output buffer: 8 bit

Pulse Rate Averaging: Standard

Fault Protection

Reverse polarity: Shunt Diode

Transient Protection: 500 VDC
(Capacitive Clamp)

Operating Mode

The Flow Computer can be thought of as making a series of measurements of flow, temperature/pressure/density sensors and then performing calculations to arrive at a result(s) which is then updated periodically on the display. The analog output, the pulse output, and the alarm relays are also updated. The cycle then repeats itself.

Step 1: Update the measurements of input signals-
Raw Input Measurements are made at each input using equations based on input signal type selected. The system notes the "out of range" input signal as an alarm condition.

Step 2: Compute the Flowing Fluid Parameters-
The temperature, pressure, viscosity, and density equations are computed as needed based on the flow equation and input usage selected by the user.

Step 3 : Compute the Volumetric Flow-
Uncompensated flow is the term given to the flow in volume units. The value is computed based on the flowmeter input type selected and augmented by any performance enhancing linearization that has been specified by the user.

Step 4: Compute the Corrected Volume Flow at Reference Conditions-
In the case of a corrected volume flow calculation, the corrected volume flow is computed as required by the selected compensation equation.

Step 5 : Compute the Mass Flow-
All required information is now available to compute the mass flow rate as volume flow times density.

Step 6: Check Flow Alarms-
The flow alarm functions have been assigned to one of the above flow rates during the setup of the instrument. A comparison is now made by comparing the current flow rates against the specified hi and low limits.

Step 7: Compute the Analog Output-
This designated flow rate value or other process value is now used to compute the analog output.

Step 8: Compute the Flow Totals by Summation-
A flow total increment is computed. The totalizer format also includes provisions for total rollover.

Step 9: Total Preset Comparisons-
The total associated with a preset function is then compared against the corresponding preset value and any required control actions taken.

Step 10: Pulse Output Service-
The pulse output is next updated by scaling the total increment which has just been determined by the pulse output scaler and summing it to any residual pulse output amount.

Step 11: Update Display and Printer Output-
The instrument finally runs a task to update the various table entries associated with the front panel display and serial outputs.

Setup Mode

The setup mode is password protected by means of numeric operator and supervisor lock out codes established by the user. In addition, a secret, manufacturers numeric unlock entry sequence is available.

The system also provides a minimum implementation of an "audit trail" which tracks significant setup changes to the unit. This feature is increasingly being found of benefit to users or simply required by Weights and Measurement Officials in systems used in commerce, trade, or "custody transfer" applications.

A software program is available which runs on a PC using a RS-232 Serial for connection to the Flow Computer. Illustrative examples may be downloaded in this manner.

The setup mode has numerous subgrouping of parameters needed for flow calculations. There is a well conceived hierarchy to the setup parameter list. Selections made at the beginning of the setup affect offerings further down in the lists.

In the setup mode, the flow computer activates the correct setup variables based on the instrument configuration, the flow equation, and the hardware selections made for the compensation transmitter type, the flow transmitter type, and meter enhancements (linearization) options selected. All required setup parameters are enabled. All setup parameters not required are suppressed.

A help line prompt is provided for each entry. In addition a help message is available which may be accessed by depressing the "HELP" key.

Also note that in the setup mode are parameter selections which have preassigned industry standard values. The unit will assume these values unless they are modified by the user.

Most of the process input variables have available a "default" or emergency value which must be entered. These are the values that the unit assumes when a malfunction is determined to have occurred on the corresponding input.

It is possible to enter in a nominal constant value for temperature, pressure or density, or analog flow inputs by placing the desired nominal value into both the lo and hi values. This is also a convenience when performing bench top tests without simulators.

Maintenance Mode:

The Maintenance Mode of the ES-747 is the Test and Calibration Mode for the device. This mode provides a number of specialized utilities required for factory calibration, instrument checkout on start-up, and periodic calibration documentation.

A supervisor password is required to gain access to this specialized mode of operation. Normally quality, calibration, and maintenance personnel will find this mode of operation very useful. It is also useful for factory testing.

Many of these tests may be used during start-up of a new system. Inputs signals may be read, and output signals may be exercised to verify the electrical interconnects before the entire system is put on line.

The following action items may be performed in the Maintenance Mode:

- Print Calibration/Maintenance Report
- Examine Audit Trail
- Perform Keypad Checkout
- Perform Display Checkout
- Perform Pulse Input Checkout
- Perform Pulse Output Checkout
- Perform Control Input Checkout
- Perform Relay Output Checkout
- Perform Analog Input Checkout
- Perform Analog Output Checkout
- Calibrate Analog Inputs using the Learn Feature
- Calibrate Analog Output using the Learn Feature
- Battery Check
- Datalog Printing and Clearing

Note that a calibration of the analog input/output will advance the audit trail counters since it effects the accuracy of the system.

RS-232 Serial Port

The ES-747 has a general purpose RS-232 Port which may be used for any one of the following purposes:

- Transaction Printing
- Periodic Printing of Datalog
- Print Internal Datalog
- Remote Metering by Modem (optional)
- Computer Communication Link
- Configuration by Computer
- Print System Setup
- Print Calibration/Malfunction History
- Remote Control

Instrument Setup by PC's over Serial Port

A Diskette program is provided with the ES-747 that enables the user to rapidly configure the ES-747 using a Personnel Computer. Included on the diskette are common instrument applications which may be used as a starting point for your application. This permits the user to have an excellent starting point and helps speed the user through the instrument setup.

Operation of Serial Communication Port with Printers

ES-747's RS-232 channel supports a number of operating modes. One of these modes is intended to support operation with a printer in metering applications requiring transaction printing, data logging and/or printing of calibration and maintenance reports.

For transaction printing, the user defines the items to be included in the printed document. The user can also select what initiates the transaction print generated as part of the setup of the instrument. The transaction document may be initiated via a front panel key depression, a remote contact closure, or upon completion of a batch.

In data logging, the user defines the items to be included in each data log as a print list. The user can also select when or how often he wishes a data log to be made. This is done during the setup of the instrument as either a time of day or as a time interval between logging.

The system setup and maintenance report lists all the instrument setup parameters and usage for the current instrument configuration. In addition, the Audit trail information is presented along with a status report listing any observed malfunctions which have not been corrected.

The user initiates the printing of this report at a designated point in the menu by pressing the print key on the front panel.

Operation of Serial Port with Modems (optional)

The ES-747 RS-232 channel supports a number of operating modes. One of these modes is intended to support operation with a modem in remote metering applications.

An external modem is intentionally being used with the ES-747. This permits use with the variety of modem standards worldwide while avoiding the specialized approvals required for equipment that is deemed to fall under the category of telecommunication equipment.

In the modem mode, the ES-747 is assumed to be operating in a remote metering role. The ES-747 will support key items in the Hayes Compatible "AT" Command Set. In this role, the ES-747 will have the following special abilities:

0. Monitor the modem status as a task of the system
1. Instruct the modem to answer an incoming call ATA
2. Respond to the calling modem at the programmed baud rate and protocol
3. Terminate the telephone connection in event the connection is lost.

In addition, the ES-747 will be capable of initiating a call to a designated telephone number in the event of a metering malfunction.

2. Installation

General Mounting Hints

2.1 General Mounting Hints:

The ES-747 Flow Computer should be located in an area with a clean, dry atmosphere which is relatively free of shock and vibration. The unit is installed in a 5.43" (138mm) wide by 2.68" (68mm) high panel cutout. (see Mounting Dimensions) To mount the Flow Computer, proceed as follows:

Mounting Procedure

- a. Prepare the panel opening.
- b. Slide the unit through the panel cutout until it touches the panel.
- c. Install the screws (provided) in the mounting bracket and slip the bracket over the rear of the case until it snaps in place.
- d. Tighten the screws firmly to attach the bezel to the panel. 3 in. lb. of torque must be applied and the bezel must be parallel to the panel.

Termination Connectors:

Minimum Wire Gauge: 22 AWG

Maximum Wire Gauge: 14 AWG

Voltage/current limits are limited by unit specifications.

Permanently Connected Equipment:

UL 3101-1, Section 6.12.2.1 specifies that:

- A switch or circuit breaker shall be included in the building installation;
- It shall be in close proximity to the equipment and within easy reach of the OPERATOR;
- It shall be marked as the disconnecting device for the equipment.

Ensure that the switch or circuit breaker chosen is suitable for the power requirements of the unit.

2.2 Mounting Diagrams:

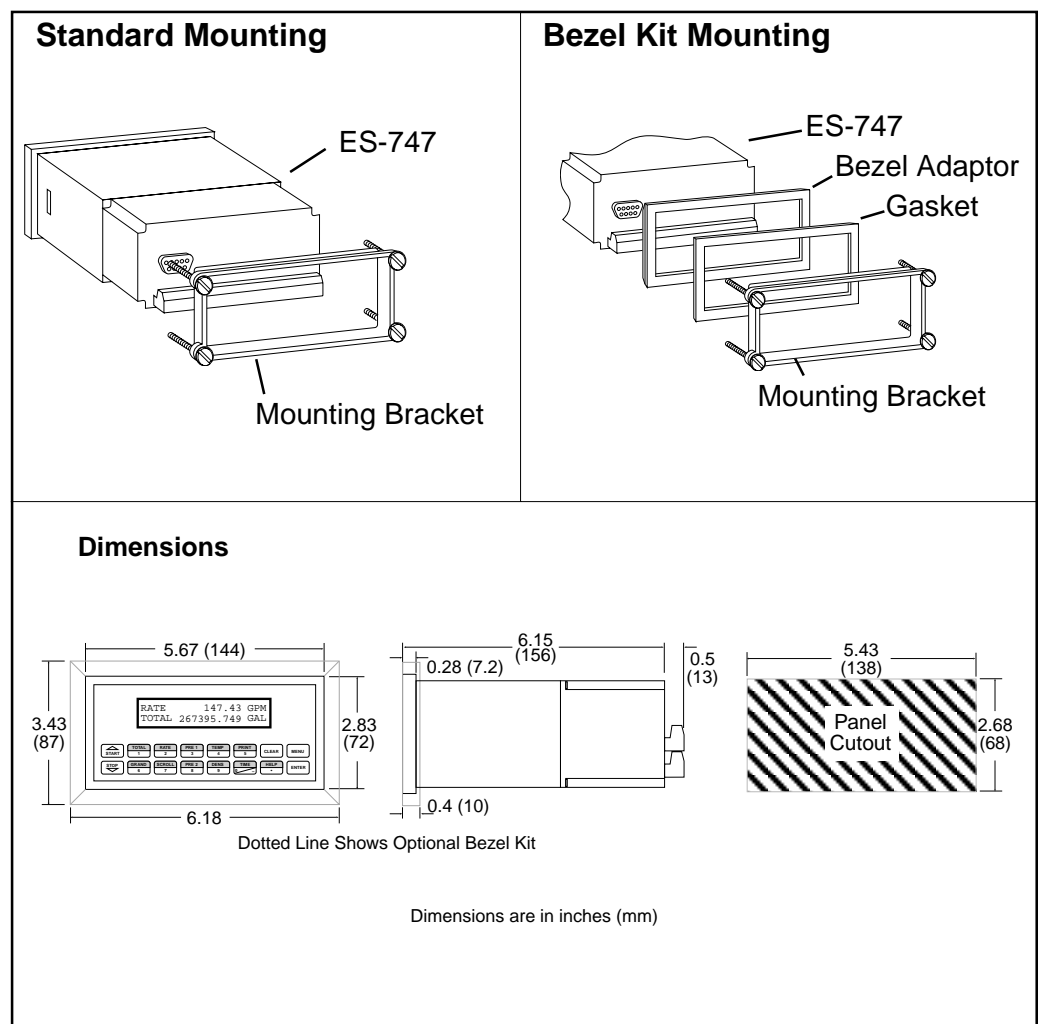

3. Applications

Liquid Volume

3.1 Liquid Volume

Measurements:

A flowmeter measures the actual volume in a liquid line. A temperature sensor can also be installed to correct for liquid thermal expansion (see 3.2 Corrected Volume).

Calculations:

- Volume flow is calculated using the flowmeter frequency output and the user entered K-Factor.

Output Results:

- Display Results
Flow Rate, Resettable Total, Non-Resettable Total
- Analog Output
Rate or Total
- Pulse Output
Total
- Relay Outputs
Rate or Total Alarms

Applications:

The Flow Computer can monitor actual volume flow and total of any liquid. Flow alarms are provided via relays and datalogging is available via analog (4-20mA) and serial outputs.

Liquid Volume Illustration

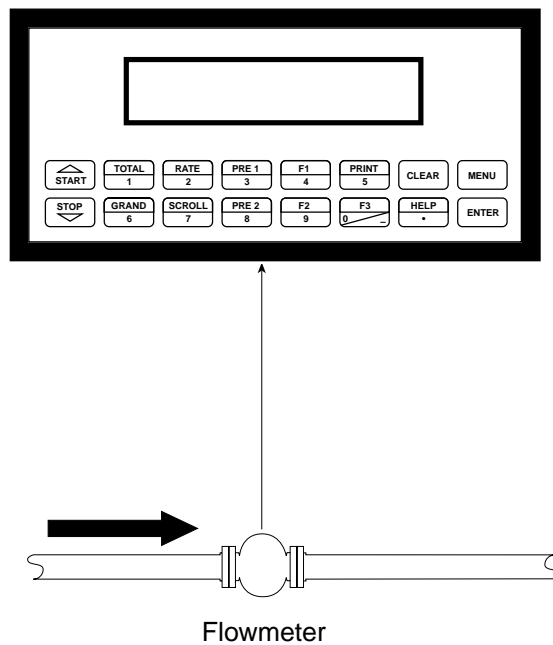

Calculations

Pulse Input; Average K-Factor

$$\text{Volume Flow} = \frac{\text{input frequency} \cdot \text{time scale factor}}{\text{K-Factor}}$$

Corrected Liquid Volume

3.2 Corrected Liquid Volume

Measurements:

A flowmeter measures the actual volume in a liquid line. A temperature sensor is installed to correct for liquid thermal expansion.

Calculations:

- Corrected Volume at a base or reference condition is calculated using the flow and temperature inputs as well as the thermal expansion coefficient stored in the flow computer. Use the "SET FLUID PROPERTIES" submenu to define reference temperature and density values for standard conditions.

Output Results:

- Display Results
Corrected Flow Rate, Resettable Total, Non-Resettable Total, Temperature, Density
- Analog Output
Corrected Rate, Total, Temperature or Density
- Pulse Output
Corrected Total
- Relay Outputs
Corrected Rate , Total or Temperature Alarms

Applications:

Monitoring corrected volume flow and total of any liquid. Flow alarms are provided via relays and datalogging is available via analog (4-20mA) and serial outputs.

Corrected Liquid Volume Illustration

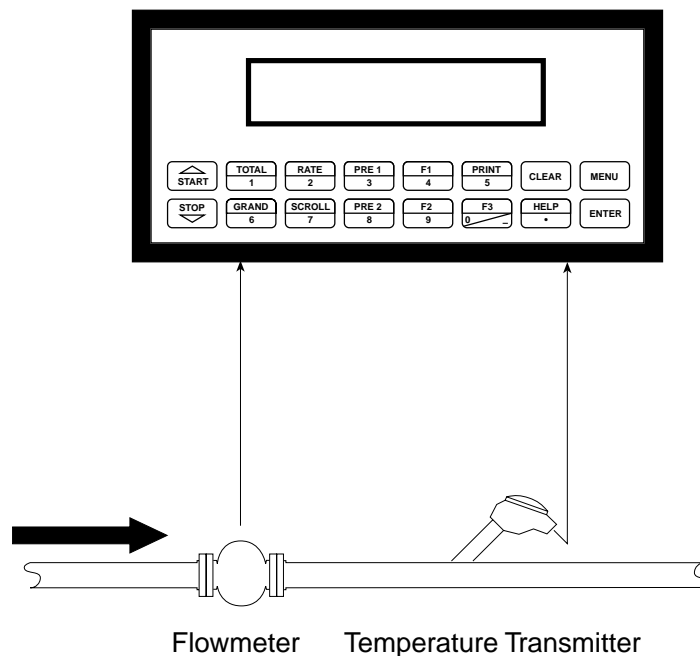

Calculations

Volume Flow

As calculated in section 3.1

Corrected Volume Flow (Temp. Transmitter)

$$\text{Corrected Volume Flow} = \text{vol. flow} * (1 - \text{Therm.Exp.Coef.} * (\text{Tf}-\text{Tref}))^2$$

(See also API 2540 equation)

Liquid Mass

3.3 Liquid Mass

Measurements:

Actual volume is measured by the flow element. Temperature is measured by the temperature transmitter. A density transmitter can be used for direct density measurements or a pressure transmitter may be utilized.

Calculations:

- The density and mass flow are measured directly or calculated using the reference density and the thermal expansion coefficient of the liquid (see "SET FLUID PROPERTIES" submenu)

Output Results:

- Display Results
Mass Flow Rate, Resettable Total, Non-Resettable Total, Temperature, Density or Pressure
- Analog Output
Mass Rate, Total, Temperature or Density or Pressure
- Pulse Output
Mass Total (corrected or uncorrected)
- Relay Outputs
Mass Flow Rate, Total, Temperature, Pressure or Density Alarms

Applications:

Monitoring mass flow and total of any liquid. Flow alarms are provided via relays and datalogging is available via analog (4-20mA) and serial outputs.

Liquid Mass Illustration

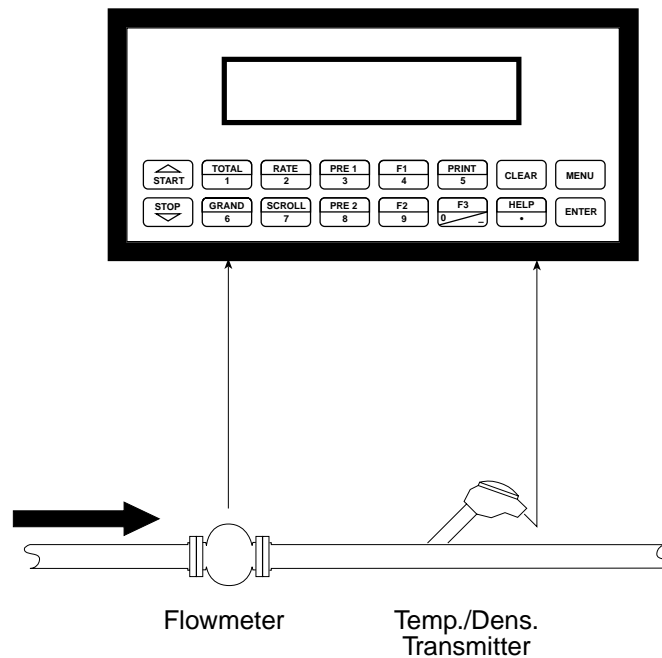

Calculations

Volume Flow

As calculated in section 3.1

Mass Flow

Mass Flow = volume flow * density

Batching

3.4 Batching

Measurements:

A flowmeter measures the actual volume in a liquid line. A temperature sensor can also be installed to correct for liquid thermal expansion (see 3.2 Corrected Volume).

Calculations:

- Volume flow is calculated using the flowmeter frequency output and the user entered K-Factor.
- Corrected Volume is calculated using the flow and temperature inputs as well as the thermal expansion coefficient stored in the flow computer.
- Comparison of the amount delivered with desired batch amount.

Output Results:

- Display Results
Flow Rate, Batch Total, Non-Resettable Total, Temperature, Density or Pressure
- Analog Output
Rate, Total, Temperature, Density or Pressure
- Pulse Output
Total (volume or corrected volume/mass)
- Relay Outputs
Batch Total, Rate, or Temperature Alarms

Applications:

Batching and monitoring flow and total of any liquid. Batching is accomplished via relays and datalogging is available via analog (4-20mA) and serial outputs.

Batching Illustration

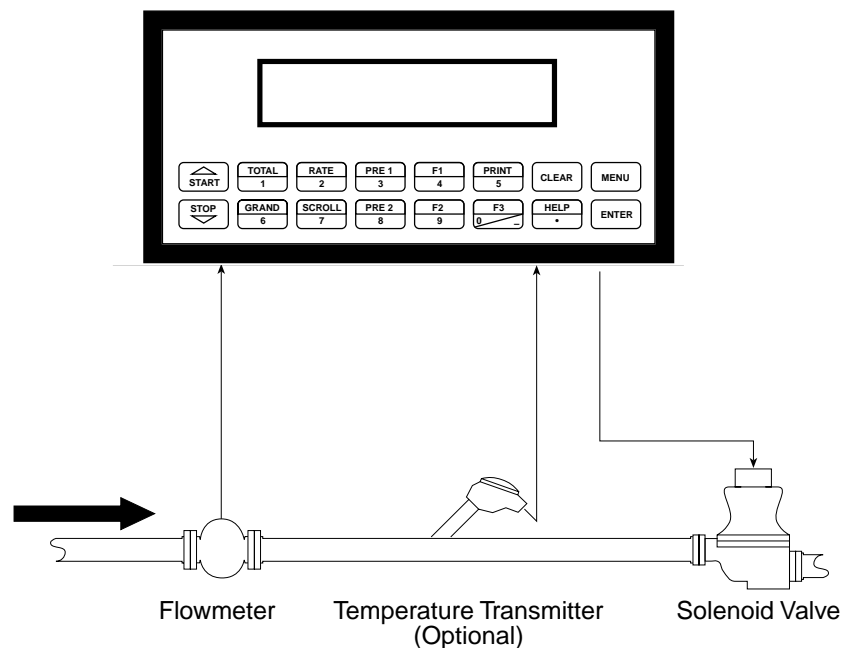

Calculations

Volume Flow

As calculated in section 3.1

Corrected Volume Flow (Temp. Transmitter)

$$\text{Corrected Vol. Flow} = \text{volume flow} * (1 - \text{Therm.Exp.Coef.} * (\text{Tf}-\text{Tref}))^2$$

(See also API 2540 equation)

CORRECTED GAS VOLUME

3.5 Corrected Gas Volume

Measurements:

A flowmeter measures the actual volume flow in a gas line. Temperature and pressure sensors are installed to measure temperature and pressure.

Calculations:

- Corrected Volume is calculated using the flow, temperature and pressure inputs as well as the gas characteristics stored in the flow computer (see "FLUID DATA" submenu). Use the "FLUID" submenu to define reference temperature and reference pressure values for standard conditions.

Output Results:

- Display Results
Corrected Volume or Actual Volume Flow Rate, Resettable Total, Non-Resettable Total, Temperature, Pressure, Density
- Analog Output
Corrected Volume or Actual Volume Flow Rate, Temperature, Pressure, Density
- Pulse Output
Corrected Volume or Actual Volume Total
- Relay Outputs
Corrected Volume Flow Rate, Total, pressure, Temperature, Density

Applications:

Monitoring corrected volume flow and total of any gas. Flow alarms are provided via relays and datalogging is available via analog (4-20mA) and serial outputs.

Corrected Gas Volume Illustration

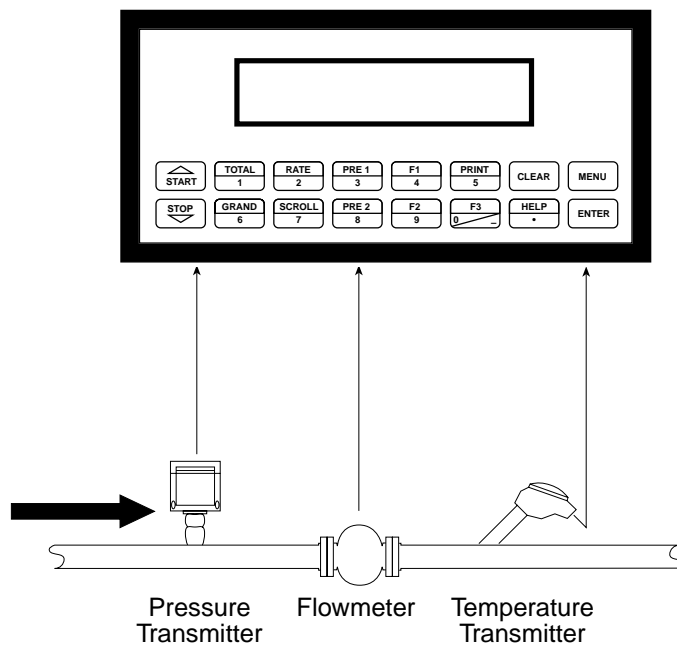

Calculations

Volume Flow

Pulse Input; Average K-Factor

$$\text{Volume Flow} = \frac{\text{input frequency} \cdot \text{time scale factor}}{\text{K-Factor}}$$

Corrected Volume Flow

$$\text{Corrected Volume Flow} = \text{Volume Flow} \cdot \frac{P}{P_{\text{ref}}} \cdot \frac{T_{\text{ref}}}{T} \cdot \frac{Z_{\text{ref}}}{Z}$$

GAS MASS

3.6 Gas Mass

Measurements:

A flowmeter measures the actual volume flow in a gas line. Temperature and pressure sensors are installed to measure temperature and pressure.

Calculations:

- Density and mass flow are calculated using gas characteristics stored in the flow computer.

Output Results:

- Display Results
Mass or Volume Flow Rate, Resettable Total, Non-Resettable Total, Temperature, Pressure, Density
- Analog Output
Mass or Volume Flow Rate, Temperature, Pressure, Density
- Pulse Output
Mass or Volume Total
- Relay Outputs
Mass or Volume Flow Rate, Total, Pressure, Temperature, Density Alarms

Applications:

Monitoring mass flow and total of gas. Flow alarms are provided via relays and datalogging is available via analog (4-20mA) and serial outputs.

Gas Mass Illustration

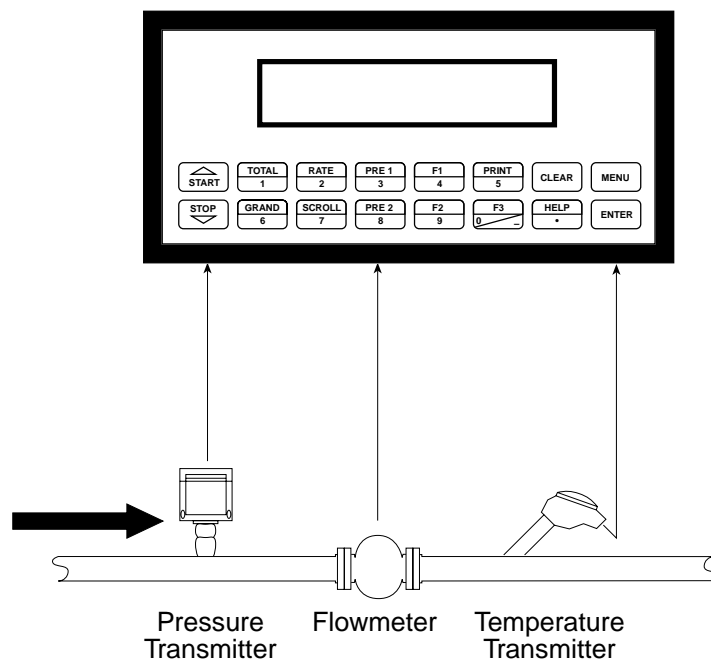

Calculations

Mass Flow

$$\text{Mass Flow} = \text{Actual Volume Flow} \cdot \rho_{\text{ref}} \cdot \frac{P}{P_{\text{ref}}} \cdot \frac{T_{\text{ref}}}{T} \cdot \frac{Z_{\text{ref}}}{Z}$$

- ρ_{ref} = Reference density
- T_{ref} = Reference temperature
- P_{ref} = Reference pressure
- Z_{ref} = Reference Z-factor

4 WIRING

Batcher Wiring

4.1 Typical Batcher Wiring:

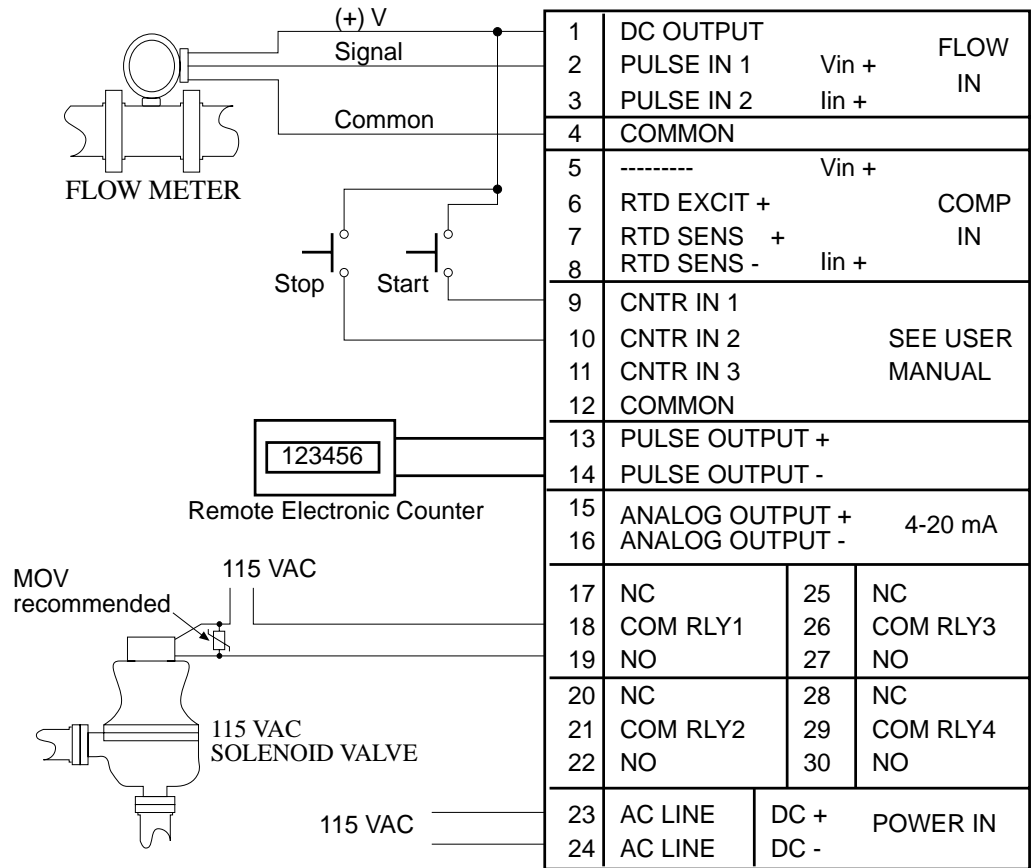

Rate / Total Wiring with RTD

4.2 Typical Rate/Total Wiring:

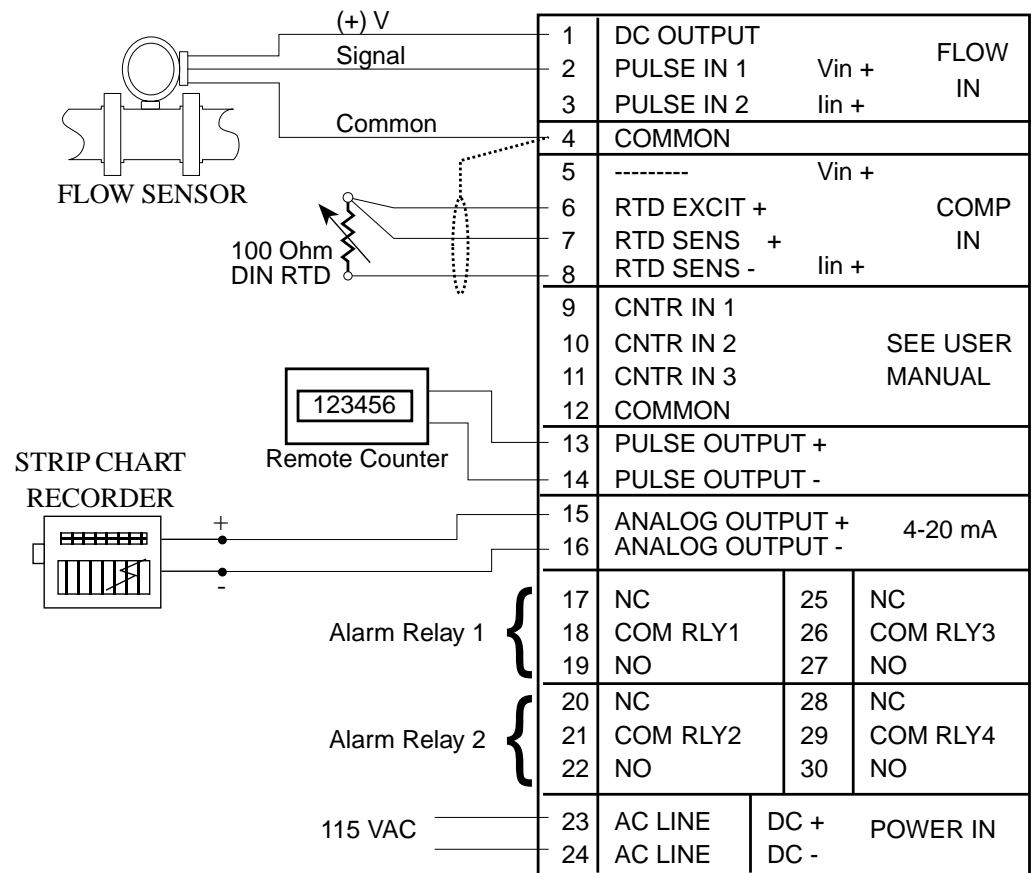

Thermistor Wiring

4.3 Typical Thermistor Wiring:

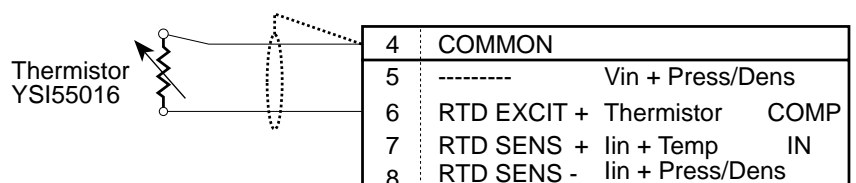

4.4 Wiring In Hazardous Areas:

Examples using MLT787S+ Barrier (MTL4755ac for RTD)

Temperature Input (4-20mA Transmitter)

Temperature Input (4-20mA Transmitter)

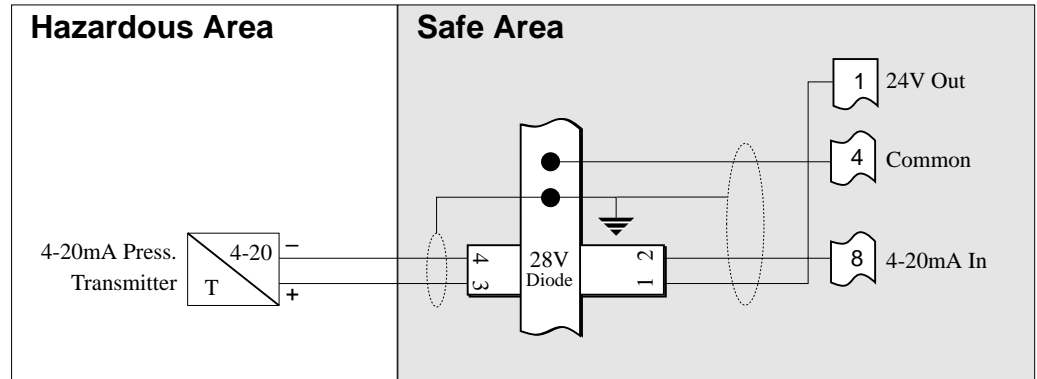

Temperature Input (RTD)

Temperature Input (RTD)

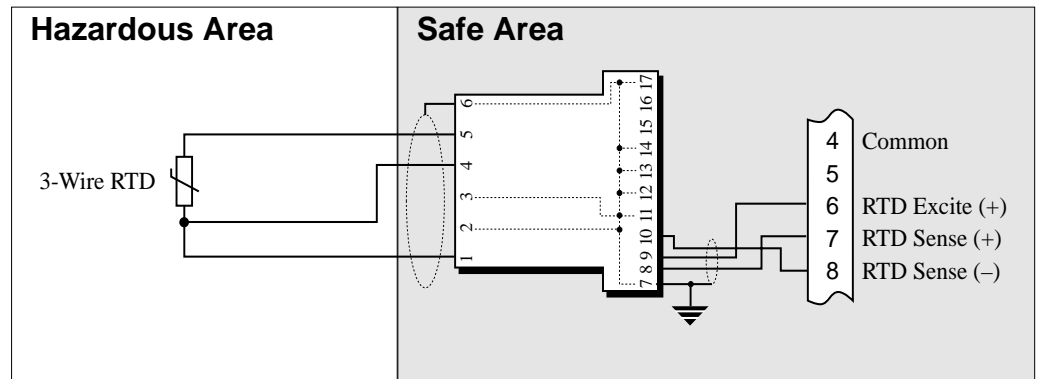

Pressure Input (4-20mA Transmitter)

Pressure Input (4-20mA Transmitter)

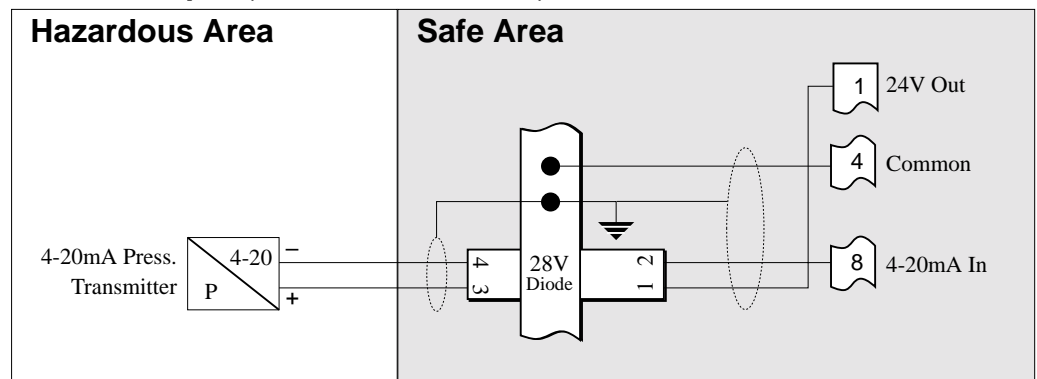

5. UNIT OPERATION

5.1 Front Panel Operation Concept for Run Mode

The ES-747 is fully programmable through the front panel. Please review the following usage summary before attempting to use the instrument.

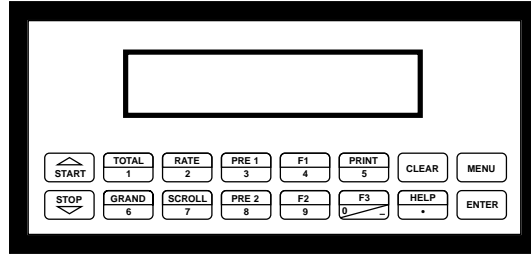

How To Use On-Line Help

HELP

On-line help is provided to assist the operator in using this product. The help is available during RUN and SETUP modes simply by pressing the HELP key. The HELP key is used to enter decimals when entering numeric values.

How To Use Function Keys

FUNCTION KEYS

In the RUN mode, several keys have a special, direct access feature, to display an item of interest (i.e. RATE, TOTAL, PRE 1, etc.). Press the key to view your choice. Press the SCROLL key to return to scrolling display. The F1, F2 & F3 keys allow the operator to view more than one piece of information. Pressing these keys additional times will display additional information.

How To Clear The Totalizer

CLEARING TOTALIZER

To clear the total, you must quickly press the TOTAL Function Key 3 times. You will be asked to verify this action. The operator will be prompted to enter password if the unit is locked.

NOTE: In the Batcher Mode, simply press the CLEAR key to reset the total (the batcher must be stopped or finished batching). It is not necessary to press the TOTAL Function Key first.

How To Clear The Grand Total

CLEARING GRAND TOTAL

To clear the grand total, you must quickly press the GRAND Function Key 3 times. You will be asked to verify this action. The supervisor will be prompted to enter the supervisor password if the unit is locked.

How To Enter Presets

PRESET KEYS

In the RUN mode, PRE 1 & PRE 2 keys are used to view and/or change the preset setpoints. To view the Presets, simply press the desired Preset key. Rapidly press the Preset keys 3 times, then press the Clear key for direct editing of the preset setpoints.

How To Select The Fluid

SELECTING THE FLUID

While holding F1 key depressed, press ENTER. Use the Δ ∇ keys to scroll through the available fluids. At desired fluid press ENTER to select fluid.

How To Create a Scroll List

SCROLL

Rapidly press the Scroll key three times to setup a display list. Press the CLEAR key to remove old scroll list. Press the function key for the item you wish to add. Use the Δ ∇ keys to assign the line.

How To Use The Print Key

PRINT

The PRINT key is used to print on demand. When the PRINT key is pressed, a user defined list of data (TOTAL, RATE, PRE 1, etc.) is sent to the RS-232 port. A timed message of "PRINTING" will be displayed to acknowledge the print request.

How To Use Special Batching Keys

SPECIAL BATCHING KEYS

The START and STOP keys are used only when batching to start and stop batches. The CLEAR key will clear the total without first pressing the TOTAL key (unit must be stopped). All other keys work the same in both Rate/Total mode and Batch mode. The Start and Stop keys operation are set by the control input settings. The Start options are: START or RESET/START. The Stop options are: STOP or STOP/RESET.

How To Use The Menu Key

MENU KEY

The MENU key is used to enter the Setup and Test modes. Press the MENU key to enter the Setup and Test modes. (See section 6 for Setup mode, section 8 for Test mode). The MENU key is also used as "escape" in Setup and Test Programming. Pressing the MENU key while programming in the Sub-Menu groups will backup the display to that Sub-Menu group heading. Pressing the MENU key while viewing the Sub-Menu groups will backup the display to the Top Level Menu.

How To Acknowledge Alarms

ACKNOWLEDGING ALARMS

Most alarm messages are self-clearing. Press the ENTER key to acknowledge and clear alarms.

NOTE: Some keys and functions are password protected. Enter the password to gain access. The passwords are factory set as follows:

Operator = 0 Supervisor = 2000

General Operation**5.2 General Operation**

The unit can display: Rate, Total, Grand Total, Temperature, Pressure, Density, Presets and Time of Day. In addition, input frequencies, computed K-factors and viscosities can be observed. The Temperature and Pressure or Density can be displayed even if you are using the Volumetric Flow Equation (a Temperature or Density sensor must be installed). The unit can perform Mass or Corrected Volume equations using a temperature, pressure or density sensor (these equations can be computed without Temp/Dens/Press sensors by using user defined default values). The unit can be programmed to perform Ratemeter/Totalizer or Batching functions (see section 6.4.2, INSTRUMENT TYPE Submenu).

Rate/Total Operation**5.3 Ratemeter/Totalizer Operation**

The Ratemeter/Totalizer mode is used primarily to monitor flowrate and accumulated total. The relays can be used to trigger flow, total, temperature pressure or density alarms.

Password Protection (Rate/Total mode)**5.3.1 Password Protection for Rate/Total mode**

After an Operator and/or Supervisor Password is entered in the setup mode (see section 6.4.23, ADMINISTRATIVE SETUP submenu), the unit will be locked. The unit will prompt the user for the password when trying to perform the following functions:

- Clear Total
- Clear Grand Total
- Enter Menu
- Edit Preset 1 (PRE 1 Key)
- Edit Preset 2 (PRE 2 Key)

The Supervisor password should be reserved for supervisors. The Supervisor password will allow access to restricted areas of the Setup and Test menus.

Relay Operation (Rate/Total mode)**5.3.2 Relay Operation in Rate/Total mode**

Up to four relays are available (two standard) for alarm outputs. The relays can be assigned to trip according to rate, total, temperature, pressure, density readings or general system alarms. The relays can be programmed for low or high alarms.

Preset 1 (RLY1) and Preset 2 (RLY2) are easily accessible by pressing the PRE 1 or PRE 2 key on the front panel. Preset 3 and Preset 4 are accessible only through the setup menu.

Pulse Output (Rate/Total mode)**5.3.3 Pulse Output in Rate/Total mode**

The isolated pulse output (open collector) is menu assignable to Volume Total and either the Corrected Volume Total or Mass Total. The pulse output duration can be set for 10mS (50 Hz max) or 100mS (5 Hz max). A pulse output scale factor (pulse value) can be set to scale the pulse output. The pulse output is ideal for connecting to remote totalizers or other devices such as a PLC. See section 1.3 for electrical specifications.

Analog Output (Rate/Total mode)**5.3.4 Analog Output in Rate/Total mode**

The analog output is menu assignable to correspond to the Volume Rate, Corrected Volume Rate or Mass Rate, Temperature, Pressure, Density, Volume Total or Corrected Volume Total or Mass Total. The analog output is ideal for "trend" tracking using strip chart recorders or other devices.

RS-232 Serial Port (Rate/Total mode)

5.3.5 RS-232 Serial Port Operation in Rate/Total mode

The RS-232 serial port can be used for programming (using the Setup Disk) or for communicating to printers and computers in the Operating Mode (Run Mode).

PC Communications:

The Setup Disk also allows the user to query the unit for operating status such as Flow Rate, Flow Total, Temperature, Pressure, Density, Presets, etc.

Operation of RS-232 Serial Port with Printers:

Transaction Printing

For transaction printing, the user defines the items to be included in the printed document (see section 6.3.20 SET DATA OUTPUT, Select_list). The transaction document can be initiated by pressing the PRINT key or by a remote contact closure.

Data Logging

In data logging, the user defines the items to be included in each data log (see section 6.3.20 SET PRINTER OUTPUT, Select_list). The user can also select when (time of day) or how often (print interval) the data log is to be made (see section 6.3.19 SET PRINTER OUTPUT, Configure). Data logs can also be initiated using the print key or control input.

System Setup and Maintenance Report

The system setup and maintenance report lists all of the instrument setup parameters and usage for the current instrument configuration. The audit trail information and a status report is also printed. This report is initiated in the Test menu (see section 8.2.3 PRINT SYSTEM SETUP).

RS-485 Serial Port (Rate/Total mode)

5.3.6 RS-485 Serial Port (optional)

RS-485 Port Description:

The optional RS-485 card utilizes Modbus RTU protocol to access a variety of process parameters and totalizers. The Relays can be controlled via Modbus. In addition, action routines can be executed. For further information, contact factory and request RS-485 Protocol manual.

Operation of Serial Communication Port with PC

The flow computer's RS-485 channel supports a number of Modbus RTU commands. Modbus RTU drivers are available for a variety of Man Machine Interface software for IBM compatible PC's.

The user reads and writes information from/to the RS-485 using the Modbus RTU commands. The ES-747 then responds to these information and command requests.

Process variables and totalizers are read in register pairs in floating point format. Time and date are read as a series of integer register values. Alarms are individually read as coils. Action routines are initiated by writing to coils.

5.4 Batcher Operation

The Batcher mode is used primarily to control batches. The main difference between the Batch mode and Rate/Total mode is the relay operation. The Batch mode allows the operator to "START" the unit via the front panel or remote input. Once started, the relays (RLY1 & RLY2) will energize and send power to a flow control device (i.e. solenoid valve or pump). The flow sensor will send a signal to the unit and total accumulation will begin. When the Prewarn value (PRE 2) is reached, Relay 2 will drop out (this is ideal for flow slow down). When the Batch amount (PRE 1) is reached, Relay 1 will drop out and the Batch is complete.

Several messages will be displayed during normal batch operation (i.e. Batch Fill, Batch Stopped). The keypad is disabled for the duration of these timed messages (approx. 2 sec).

Batcher Configuration

5.4.1 Batcher Configuration.

When the unit is programmed for batch mode, several batch operation choices are available. These choices include: Up or Down Counting, Maximum Batch Preset, Batch Overrun Compensation, Auto Batch Restart, Time Delay, Flow Signal Timeout, Maximum Drain Time, Slow Start Quantity, Start or Reset/Start, and Stop or Stop/Reset.

Batch Count Mode

The Batch Count Mode allows the user to choose whether the unit will batch up to a preset value or batch down from a preset value to zero.

Maximum Batch Preset

The Maximum Batch Preset allows the user to program the Maximum Batch value allowed to be entered by the operator. If an operator should try to program a batch higher than this value, the unit will not allow the value to be entered and will prompt the user with an error message saying that the Maximum Batch Preset has been exceeded.

Batch Overrun

The Batch Overrun is used for batch applications that have slow responding valves and a consistent batching flowrate. When the Batch Overrun is set, the unit will compensate for batch overruns by computing an averaged overrun value from the last four batches. This average is used to internally adjust the batch setpoint to minimize overrun.

Auto Batch Restart

The Auto Batch Restart function allows the user to set an amount of time to automatically restart a batch after the completion of a batch. This time can be set from 1 to 99 seconds.

Time Delay

The Time Delay for Auto Batch Restart functions as follows: When a batch is completed, the next batch will automatically start after the amount of time entered here.

Flow Signal Timeout

The Flow Signal Timeout allows the user to enter a timeout of 0 to 99 seconds. If a batch is "Filling" and zero flow persists for more than the user entered time then the batch will be aborted. This prevents over flows due to faulty flow sensors and/or wiring.

Maximum Drain Time

The unit declares that a batch is "done" when the flow rate equals "0". A flow rate may be present long after the Preset Relay de-energizes due to slow reacting valves or leaky valves. The Maximum Drain Time allows the user to enter an amount of time (0 to 99 seconds) to wait before declaring "Batch Done". After the Preset Batch quantity is reached, the unit will declare "Batch Done" when the flow rate is "0" or the Maximum Drain Time has expired. The batch data will then be available for printing and datalogging.

Slow Start Quantity

The Slow Start Quantity is a function that allows an amount to be entered for a Slow Start up. This function requires two stage valve control. RLY 1 (slow flow) will energize for Slow Start and RLY 2 (fast flow) will energize after the Slow Start Quantity has been delivered. This helps reduce turbulence when filling an empty container.

START, RESET/START and STOP, STOP/RESET

When configuring the control inputs, Control Input1 can be set for START or RESET/START. When set for START, the unit will start batching when a signal is applied to Control Input1 or the front panel Start key is pressed. A separate Reset signal must be used to clear the previous batch total. When set for RESET/START, the unit will automatically reset then start when a signal is applied to Control Input1 or the front panel Start key is pressed (provided that the pervious batch was completed). If a previous batch was stopped during a batch cycle, the unit will Start from where it was stopped.

Control Input 2 can be set for STOP or STOP/RESET. When set for STOP, the unit will stop batching when a signal is applied to Control Input 2 or the front panel Stop key is pressed. A separate Reset signal must be used to clear the batch total. When set for STOP/RESET, a running batch will stop when a signal is applied to Control Input 2 or the front panel Stop key is pressed. If the unit is Stopped or after a completed batch, the unit will reset when a signal is applied to Control Input 2 or the front panel Stop key is pressed.

NOTE: Applying a high logic level to Control Input 2 will inhibit all Start inputs in either mode.

Password Protection
(Batch mode)**5.4.2 Password Protection for Batcher Mode**

After an Operator and/or Supervisor Password is defined in the setup mode (see section 6.4.23, ADMINISTRATIVE SETUP submenu), the unit will be locked when you return to the run mode. The unit will prompt the user for the password when trying to perform the following functions:

Clear Grand Total
Enter Menu

The Supervisor password should be reserved for supervisors. The Supervisor password will allow access to restricted areas of the Setup and Test menus.

The passwords are factory set as follows:

Operator = 0
Supervisor = 2000

Relay Operation
(Batch mode)**5.4.3 Relay Operation in Batcher mode**

Up to four relays are available (two standard) for alarm outputs. Preset 1 (RLY1) is reserved for batch amount, Preset 2 (RLY2) is reserved for prewarn. Preset 1 (RLY1) and Preset 2 (RLY2) are easily accessible by pressing the PRE 1 or PRE 2 key on the front panel. Preset 3 and Preset 4 are accessible only through the setup menu.

Relays 3 and 4 can be assigned to trip according to rate, total, temperature, pressure, density, overrun or alarm. When rate, temperature, pressure or density is selected the relays can be programmed for low or high alarms.

Pulse Output
(Batch mode)**5.4.4 Pulse Output in Batcher mode**

The isolated pulse output (open collector) is menu assignable to Volume Total, and either Corrected Volume Total or Mass Total. The pulse output duration can be set for 10mS (50 Hz max) or 100mS (5 Hz max). A pulse output scale factor (pulse value) can be set to scale the pulse output. The pulse output is ideal for connecting to remote totalizers or other devices such as a PLC. See section 1.3 for electrical specifications.

Analog Output
(Batch mode)**5.4.5 Analog Output in Batcher mode**

The analog output is menu assignable to correspond to the Volume Rate, Corrected Volume Rate or Mass Rate, Temperature, Pressure, Density, and Total. The analog output is ideal for "trend" tracking using strip chart recorders or other devices.

RS-232 Serial Port (Batch mode)

5.4.6 RS-232 Serial Port Operation in Batch mode

The RS-232 serial port can be used for programming (using the Setup Disk) or for communicating to printers and computers in the Operating Mode (Run Mode).

PC Communications:

The Setup Disk also allows the user to query the unit for operating status such as Flow Rate, Flow Total, Temperature, Pressure, Density, Presets, etc.

Operation of RS-232 Serial Port with Printers:

Transaction Printing

For transaction printing, the user defines the items to be included in the printed document (see section 6.4.22 SET DATALOG/PRINT, Select_list). The transaction document can be initiated by pressing the PRINT key, by a remote contact closure or print at end of batch.

Data Logging

In data logging, the user defines the items to be included in each data log (see section 6.4.22 SET DATALOG/PRINT, Select_list). The user can also select when (time of day) or how often (print interval) the data log is to be made (see section see section 6.4.21 SET DATALOG/PRINT, Configure).

System Setup and Maintenance Report

The system setup and maintenance report lists all of the instrument setup parameters and usage for the current instrument configuration. The audit trail information and a status report is also printed. This report is initiated in the Test menu (see section 8.2.3 PRINT SYSTEM SETUP).

RS-485 Serial Port (Batch mode)

5.4.7 RS-485 Serial Port (optional)

RS-485 Port Description:

The optional RS-485 card utilizes Modbus RTU protocol to access a variety of process parameters and totalizers. Batches/Relays can be controlled remotely via Modbus. In addition, action routines can be executed. For further information, contact factory and request RS-485 Protocol manual.

Operation of Serial Communication Port with PC

The flow computer's RS-485 channel supports a number of Modbus RTU commands. Modbus RTU drivers are available for a variety of Man Machine Interface software for IBM compatible PC's.

The user reads and writes information from/to the RS-485 using the Modbus RTU commands. The ES-747 then responds to these information and command requests.

Process variables and totalizers are read in register pairs in floating point format. Time and date are read as a series of integer register values. Alarms are individually read as coils. Action routines such as Start, Stop, Reset are initiated by writing to coils.

6. PROGRAMMING

6.1 Front Panel Operation Concept for Program Mode

The ES-747 is fully programmable through the front panel. Please review the following usage summary before attempting to use the instrument.

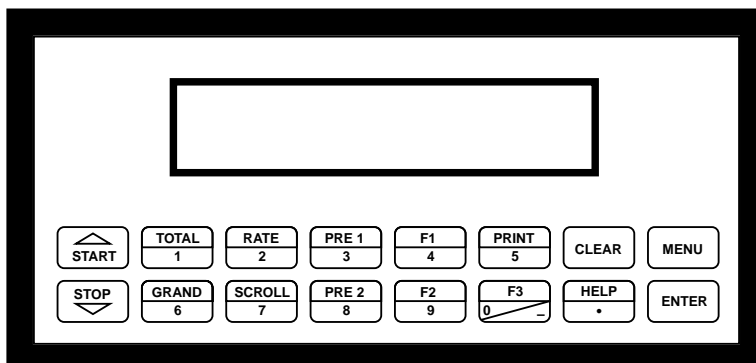

Setup Mode:

How To Make Mode Changes

MODE CHANGES

Pressing the MENU key will offer selections of RUN, SETUP, TEST. RUN is the normal operating mode for the instrument. SETUP offers various sub-menus used for instrument setup. TEST offers various sub-menus for Test, Calibration and System Start-up.

How To Navigate Through Sub-Menu Groups

Submenu GROUP NAVIGATION

Use the UP and DOWN arrow keys to navigate up and down through the Sub-Menu groups when in the SETUP or TEST mode. Press the ENTER key to enter a desired setup or test Sub-Menu group.

How To Select Program Choices

SELECTION OF ITEM

During setup, the unit will often offer multiple choices for a given topic. The topic prompt appears on the top line of the display. The choices are shown on the lower line of the display.

To select an item, press the key beneath the desired choice. The selected choice will blink. Press the ENTER key to accept the selected choice.

How To Enter Numeric Values

NUMERIC ENTRY

The keys labeled "0 - 9", "-", ".", CLEAR and ENTER are used to enter numerical values. A leading 0 will assume that you intend to enter a minus "-" sign. Press the CLEAR key to clear the existing value and to enable editing.

How To Enter Text Characters

TEXT CHARACTER ENTRY

Some setup items (i.e. Descriptors, Units Label) require the user to enter text characters. Press CLEAR to enable editing. The UP and DOWN arrow keys are used to scroll through the available character sets for each individual character. Press the ENTER key to accept the character and advance to the next character.

6.2 Setup Menus

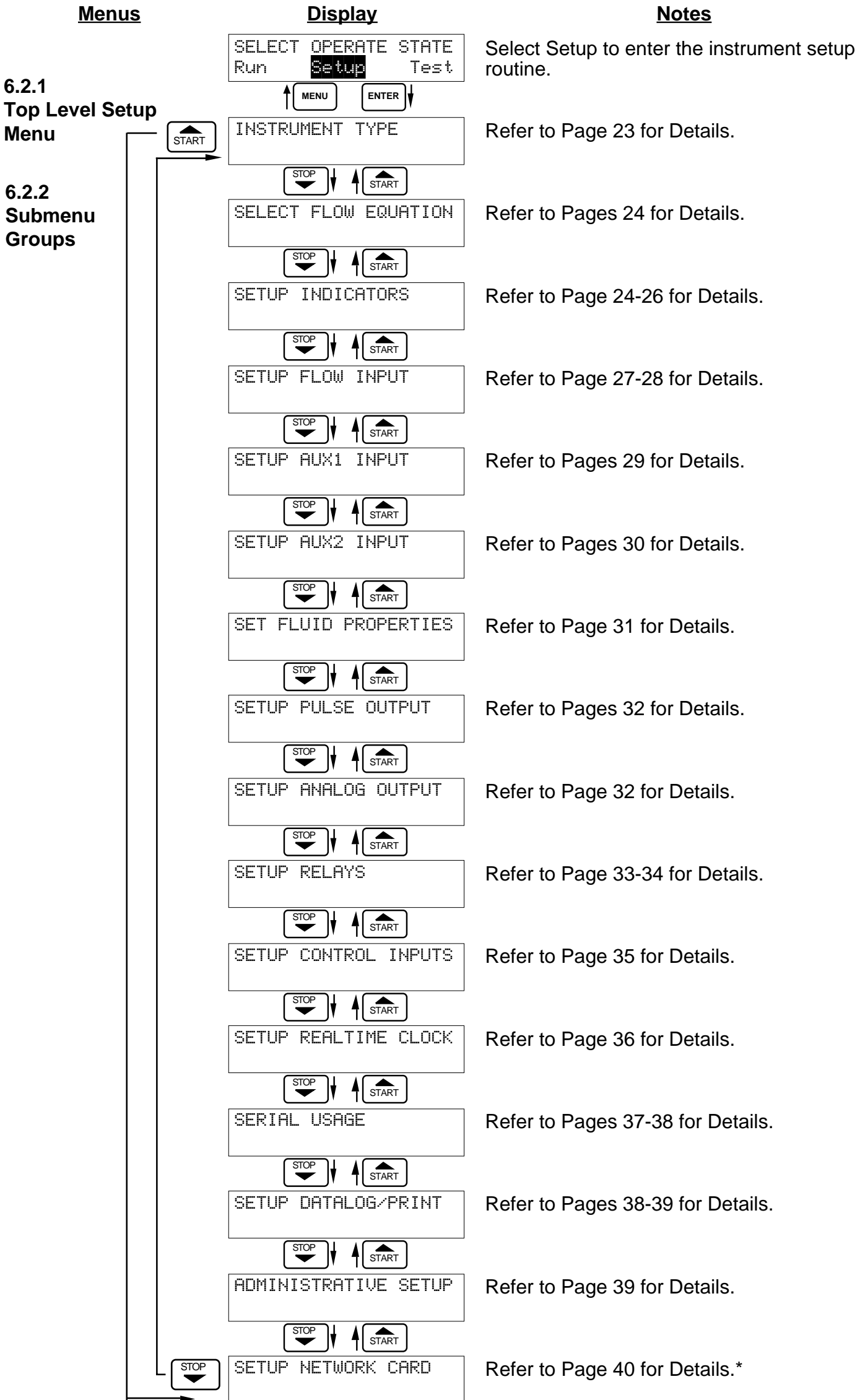

* Optional Menu only appears if option is installed

6.3 Setup Sub-Menus

Sub-menus	Notes
6.3.1 INSTRUMENT TYPE	Press ENTER to enter Instrument Type sub-menu.
Rate/Tot	Press ENTER when Rate/Total is flashing to configure the instrument as a Ratemeter/ Totalizer.
Batch	If Rate/Tot selected, advance to Select Flow Equation.
Batch	Press ENTER to enter Instrument Type sub-menu.
Batch	Press ENTER when Batch is flashing to configure the instrument as a Batcher.
Batch	Select UP to Reset to 0 and count up to preset. Select DOWN to reset to Preset and count down to 0.
Batch	Enter the maximum allowable Batch Preset. The operator will not be able to enter a batch preset larger than this value.
Batch	Select ON to set the unit to operate using a Batch Overrun Compensation routine. Select OFF to inhibit Batch Overrun Compensation routine. (See Section 5.4)
Batch	Select On to enable the Auto Batch Restart. This will automatically restart the unit at the end of each batch run. Select Off if this is not desirable.
Batch	Enter Time Delay for Auto Batch Restart. When a batch is completed, the next batch will start after the amount of time entered here.
Batch	Enter a timeout of 0 to 99 seconds. If a batch is "Filling" and zero flow persists for more than this time, the batch will be aborted.
Batch	Enter time (0-99 sec.) for Max. Drain Time. After batch quantity is reached, "Batch Done" is declared when the flow rate is "0" or the Maximum Drain Time has expired.
Batch	Enter a quantity for a Slow Start up. RLY 2 (slow flow) will energize for Slow Start and RLY 1 (fast flow) will energize after the Slow Start Quantity has been delivered.
Batch	Select "Yes" to inhibit totalization during the auto batch restart delay.
Batch	Advance To SELECT FLOW EQUATION

Sub-menus	Display	Notes
6.3.2 SELECT FLOW EQUATION	SELECT FLOW EQUATION	Press ENTER to enter Select Flow Equation submenus.
	ENTER ↓	
	SELECT FLUID MEDIA Liquid Gas	Press ENTER when desired fluid media is flashing.
	ENTER ↓	
	SELECT FLOW EQUATION Volume Mass Cor/Vol	Press ENTER when desired flow equation is flashing.
	ENTER ↓	
	Advance To SETUP INDICATORS (Total)	
6.3.3 SETUP INDICATORS (Total)	SETUP INDICATORS	Press ENTER to begin setup of the Indicators
	ENTER ↓	
	SETUP INDICATORS Tot Dns Rte Tmp Pres	Press ENTER when Total is flashing to configure the Totalizer Indicators
	ENTER ↓	
	TOTAL DESCRIPTOR TOTAL	Enter the desired Total Descriptor
	ENTER ↓	
	TOTAL VOLUME UNITS gal	Enter the desired Volume Units Label for the Totalizer.
	ENTER ↓	
	TOT DEC PLACES (0-3) 0	Select the desired Total Decimal Place. 0-3 decimal places allowed.
	ENTER ↓	
	Advance To SETUP INDICATORS (Density)	
6.3.4 SETUP INDICATORS (Density)	SETUP INDICATORS Tot Dns Rte Tmp Pres	Press ENTER when Dns is flashing to configure the Density Indicators.
	ENTER ↓	
	DENSITY DESCRIPTOR DENS	Enter the desired Density Descriptor.
	ENTER ↓	
	DENSITY MASS UNITS lbs	Enter the desired Mass Units Label for Density.
	ENTER ↓	
	DENS DEC PLACES(0-6) 4	Select the desired Density Decimal Place. 0-6 decimal places allowed.
	ENTER ↓	
	DENSITY DEFAULT 1 lbs/g	Enter the default density setting.
	ENTER ↓	
	Advance To SETUP INDICATORS (Rate)	

Sub-menus	Display	Notes
6.3.5 SETUP INDICATORS (Rate)	<pre> SETUP INDICATORS Tot Dns Rte Tmp Pres [ENTER] ↓ RATE TIME BASE Sec Min Hour Day [ENTER] ↓ RATE DESCRIPTOR RATE [ENTER] ↓ RATE DEC PLACES(0-3) 2 [ENTER] ↓ RATE AVG FILTER 0 [ENTER] ↓ QUICK UPDATE % 1 [ENTER] ↓ Advance To SETUP INDICATORS (Temperature) </pre>	<p>Press ENTER when Rate is flashing to configure the Ratemeter Indicators</p> <p>Select the desired Rate Time Base.</p> <p>Enter the desired Descriptor for the Ratemeter.</p> <p>Select the desired Rate Decimal Place. 0-3 decimal places allowed.</p> <p>Enter desired Rate Averaging Filter.</p> <p>Enter desired Percent of Change for Quick Update. If the current flowrate deviates by an amount greater than the percentage value entered, the Rate Averaging is restarted with new value.</p>
6.3.6 SETUP INDICATORS (Temperature)	<pre> SETUP INDICATORS Tot Dns Rte Tmp Pres [ENTER] ↓ TEMP DESCRIPTOR TEMP [ENTER] ↓ TEMPERATURE SCALE Deg_C Deg_F [ENTER] ↓ TEMP DEC PLACES(0-3) 1 [ENTER] ↓ TEMPERATURE DEFAULT 60 F [ENTER] ↓ Advance To SETUP INDICATORS (Pressure) </pre>	<p>Press ENTER when Temp is flashing to configure the Temperature Indicators.</p> <p>Enter the desired Temperature Descriptor.</p> <p>Enter the desired Temperature Scale.</p> <p>Select the desired Temperature Decimal Place. 0-3 decimal places allowed.</p> <p>Enter the default temperature</p>

Sub-menus	Display	Notes
6.3.7 SETUP INDICATORS (Pressure)	<pre> SETUP INDICATORS Tot Dns Rte Tmp Pres </pre>	Press ENTER when Pres is flashing to configure the Pressure Indicators.
	<pre> ENTER ↓ </pre>	
	<pre> PRES UNITS Absolute Gauge </pre>	Enter the Pressure Units Referenced.
	<pre> ENTER ↓ </pre>	
	<pre> PRESSURE DESCRIPTOR PRESS </pre>	Enter the desired Pressure Descriptor using the up/down arrow keys.
	<pre> ENTER ↓ </pre>	
	<pre> PRESSURE UNITS psia </pre>	Enter the desired Pressure Units using the up/down arrow keys.
	<pre> ENTER ↓ </pre>	
	<pre> PRES DEC PLACES(0-3) 2 </pre>	Select the desired Pressure Decimal Place. 0-3 decimal places allowed.
	<pre> ENTER ↓ </pre>	
	<pre> PRESSURE DEFAULT 50.000 psia </pre>	Enter the default pressure.
	<pre> ENTER ↓ </pre>	
	<pre> BAROMETRIC PRESSURE 14.696 psia </pre>	Enter barometric pressure.
	<pre> ENTER ↓ </pre>	
	<pre> Advance To SETUP FLOW INPUT </pre>	

Submenus	Display	Notes
6.3.8 SETUP FLOW INPUT	<pre> SETUP FLOW INPUT </pre>	Press ENTER to begin setup of Flow Input.
	<pre> ENTER ↓ EXCITATION VOLTAGE 5v 12v 24v </pre>	Select the desired Excitation Voltage.
NOTE: ChA = Single Pulse A=B = Pulse Security Qx1 = Quadrature Qx2 = Quadrature x 2	<pre> PULSE INPUT TYPE ChA A=B Qx1 Qx2 </pre>	Enter the desired Pulse type. See side note.
	<pre> ENTER ↓ PULSE TRIGGER LEVEL 10mV 100mV 2.5V </pre>	Select the desired Input Pulse Trigger Level.
	<pre> ENTER ↓ LOW PASS FILTER 40Hz 3KHz 20KHz </pre>	Select the desired Low Pass Filter. (Max. Count Speed).
	<pre> ENTER ↓ INPUT TERMINATION Pullup Pulldown None </pre>	Select the proper input termination.
	<pre> ENTER ↓ MAX WINDOW (1-99) 1 sec </pre>	Enter the desired Maximum Sample Window Time (1-99 sec).
NOTE: AvgK = Average K-Factor LinTbl = Linearization Table UVC = Universal Viscosity Curve StRo = Strouhal Roshko Curve	<pre> ENTER ↓ K_FACTOR TYPE AvgK LinTbl UVC StRo </pre>	Enter the desired K-Factor Type. See side note.
	<pre> ENTER ↓ AVERAGE KA-FACTOR ##### P/gal </pre>	If Avg selected, Enter the desired Average K-Factor (KA for channel A).
	<pre> AVERAGE KB-FACTOR ##### P/gal </pre>	Enter the desired Average K-Factor (KB for channel B).
	<pre> CHANGE TABLE A Yes NO </pre>	If LinTbl selected, Select YES to change table Enter the desired frequency/ K-Factor pair (in ascending order) for each point in the Linearization Table. (channel A)
	<pre> ENTER ↓ LINEAR TABLE KA Fre01:##### Hz </pre>	NOTE: Enter 0 for Fre value of any point (other than Fre01) to exit the routine and use the values entered up to that point.
	<pre> ENTER ↓ LINEAR TABLE KA KA--01:##### P/gal </pre>	Enter the desired frequency/ K-Factor pair (in ascending order) for each point in the Linearization Table. (channel B)
	<pre> ENTER ↓ CHANGE TABLE B Yes NO </pre>	NOTE: Enter 0 for Fre value of any point (other than Fre01) to exit the routine and use the values entered up to that point.
	<pre> ENTER ↓ LINEAR TABLE KB Fre01:##### Hz </pre>	If UVC selected, Select YES to change table Enter the desired Hz/ck/ K-Factor pair (in ascending order) for each point in the Linearization Table. (channel A)
	<pre> ENTER ↓ LINEAR TABLE KB KB--01:##### P/gal </pre>	NOTE: Enter 0 for Hz/ckvalue of any point (other than Hz/ck01) to exit the routine and use the values entered up to that point.
	<pre> ENTER ↓ LINEAR TABLE KA Fre01:##### Hz/ck </pre>	Enter the desired Hz/ck/ K-Factor pair (in ascending order) for each point in the Linearization Table. (channel B)
	<pre> ENTER ↓ LINEAR TABLE KA KA--01:##### P/gal </pre>	NOTE: Enter 0 for Hz/ck value of any point (other than Hz/ck01) to exit the routine and use the values entered up to that point.
	<pre> ENTER ↓ LINEAR TABLE KB Fre01:##### Hz/ck </pre>	
	<pre> ENTER ↓ LINEAR TABLE KB KB--01:##### P/gal </pre>	

Through 40 Points

Through 40 Points

Through 40 Points

Through 40 Points

Continued On Next Page

Sub-menus	Display	Notes
6.3.8 SETUP FLOW INPUT (continued)	Through 40 Points LINEAR TABLE KA RoA01:##### ENTER ↓	If StRo selected, Enter the desired St/ Ro pair (in ascending order) for each point in the Linearization Table. (channel A) NOTE: Enter 0 for Ro value of any point (other than RoA01) to exit the routine and use the values entered up to that point.
	LINEAR TABLE KA StA01:##### ENTER ↓	
	Through 40 Points LINEAR TABLE KB RoB01:##### ENTER ↓	Enter the desired St/ Ro pair (in ascending order) for each point in the Linearization Table. (channel B) NOTE: Enter 0 for Ro value of any point (other than RoB01) to exit the routine and use the values entered up to that point.
	LINEAR TABLE KB StB01:##### ENTER ↓	
	LOW FLOW RATE ALARM ##### gal/s ENTER ↓	Enter the desired volumetric Low Rate Alarm. This will trigger an alarm message if alarm conditions occur. The relays are not affected.
	HIGH FLOW RATE ALARM ##### gal/s ENTER ↓	Enter the desired volumetric High Rate Alarm. This will trigger an alarm message if alarm conditions occur. The relays are not affected.
	METER EXPAN [xe - 6] 0 ppm/f ENTER ↓	If StRo selected, Enter the expansion coefficient for the meter housing.
	CALIBRATION TEMPERATURE 70 F ENTER ↓	If StRo selected, Enter the calibration temperature.
	H2O DENSITY AT 4 DEG C 8.34519 lbs/g ENTER ↓	If UVC or StRo selected, Enter the density of water at 4° C.
	Advance To SETUP AUX1 INPUT	

Sub-menus	Display	Notes
6.3.9 SETUP AUX1 INPUT	<pre> SETUP AUX1 INPUT </pre>	Press ENTER to begin setup of the Auxiliary 1 Input.
	<pre> ENTER </pre>	
	<pre> AUX1 INPUT TYPE None Temp </pre>	Select Temperature to set the Auxiliary 1 Input for Temperature inputs.
	<pre> ENTER </pre>	
	<pre> AUX1 SIGNAL TYPE Therm Current RTD </pre>	Choose Temperature Signal Type. (If RTD selected, AUX2 will not be available for Density or Pressure)
	<pre> ENTER </pre>	
	<pre> INPUT SIGNAL RANGE 4-20mA 0-20mA </pre>	If Current selected, Choose desired Current Range. Skip if Thermistor or RTD.
	<pre> ENTER </pre>	
	<pre> AUX1 LOW SCALE ##### F </pre>	Enter the low temperature scale corresponding to the low temperature signal. Skip if Thermistor or RTD.
	<pre> ENTER </pre>	
	<pre> AUX1 FULL SCALE ##### F </pre>	Enter the high temperature scale corresponding to the high temperature signal. Skip if Thermistor or RTD.
	<pre> ENTER </pre>	
	<pre> OFFSET TEMPERATURE ##### F </pre>	Enter the offset temperature.
	<pre> ENTER </pre>	
	<pre> AUX1 LOW ALARM ##### F </pre>	Enter the Low setpoint for the Temperature Alarm.
	<pre> ENTER </pre>	
	<pre> AUX1 HIGH ALARM ##### F </pre>	Enter the High setpoint for the Temperature Alarm.
	<pre> ENTER </pre>	
	<pre> DENS EXTRACT METHOD Therm_Coef API-2540 </pre>	Enter the Density Extract Method to be used.*
	<pre> ENTER </pre>	
	<pre> Advance To SETUP AUX2 INPUT </pre>	* Only appears if RTD selected.

Sub-menus	Display	Notes
6.3.10 SETUP AUX 2 INPUT	<pre> SETUP AUX2 INPUT </pre>	Press ENTER to begin setup of the Auxiliary Input 2.
NOTE: When Density (Dens) is selected, The menu prompts will be very similar to the Pressure prompts. The menus will prompt the user for density values and density units.	<pre> ENTER ↓ </pre>	Select Pressure to set the Auxiliary Input 2 for Pressure inputs.
	<pre> AUX 2 INPUT TYPE None Dens Press </pre>	Select Pressure to set the Auxiliary Input 2 for Pressure inputs.
	<pre> ENTER ↓ </pre>	Choose Pressure Signal Type.
	<pre> AUX 2 SIGNAL TYPE Voltage Current </pre>	Choose Pressure Signal Type.
	<pre> ENTER ↓ </pre>	If Current selected, Choose desired Current Range.
	<pre> CURRENT RANGE 4-20mA 0-20mA </pre>	If Current selected, Choose desired Current Range.
	<pre> ENTER ↓ </pre>	Enter the low pressure scale corresponding to the low pressure signal.
	<pre> AUX LOW SCALE ##### PSIA </pre>	Enter the low pressure scale corresponding to the low pressure signal.
	<pre> ENTER ↓ </pre>	Enter the high pressure scale corresponding to the high pressure signal.
	<pre> AUX FULL SCALE ##### PSIA </pre>	Enter the high pressure scale corresponding to the high pressure signal.
	<pre> ENTER ↓ </pre>	Enter the Low setpoint for the Pressure Alarm.
	<pre> AUX LOW ALARM ##### PSIA </pre>	Enter the Low setpoint for the Pressure Alarm.
	<pre> ENTER ↓ </pre>	Enter the High setpoint for the Pressure Alarm.
	<pre> AUX HIGH ALARM ##### PSIA </pre>	Enter the High setpoint for the Pressure Alarm.
	<pre> ENTER ↓ </pre>	If None or Press selected, Choose the Density Extraction method to be used.*
	<pre> DENS EXTRACT METHOD Therm_Coef API_2540 </pre>	If None or Press selected, Choose the Density Extraction method to be used.*
	<pre> ENTER ↓ </pre>	* If not Density transmitter and not RTD.
	<pre> Advance To SET FLUID PROPERTIES </pre>	* If not Density transmitter and not RTD.

Sub-menus	Display	Notes	
6.3.11 SET FLUID PROPERTIES	SET FLUID PROPERTIES	Press ENTER at this prompt to Set Fluid Properties.	
	ENTER ↓	FLUID NUMBER (0-9) 0	Up to 10 Fluid types may be stored in the unit. Select the number of the desired fluid to edit.
	ENTER ↓	FLUID NAME Generic #0	Shows name and number of fluid selected. Enter the desired name using the up/down arrow keys.
	ENTER ↓	REF. DENSITY ##### lbs/g	Enter the Reference Density. This is used in the calculation of density when you have a temp transmitter and used for corrected flow calculation if you have a density transmitter.
	ENTER ↓	REF. TEMPERATURE ##### F	Enter the Reference Temperature.
	ENTER ↓	EXPAN. FACTOR [xe-6] #####	Enter the proper Fluid Expansion Factor. (If Temp Compensated for Mass or Corrected Volume) See Section 7.3, Calculating the Fluid Expansion Factor.
	ENTER ↓	VISCOSITY COEF. A 0.000	Enter the Viscosity A Coefficient. See section 7.4, Computation of Viscosity Coef. A and B.
	ENTER ↓	VISCOSITY COEF. B 0.000	Enter the Viscosity B Coefficient. See section 7.4, Computation of Viscosity Coef. A and B.
	ENTER ↓	REFERENCE PRESSURE ##### PSIA	Enter the Pressure of the fluid at reference conditions.
	ENTER ↓	Z-FACTOR #####	Enter the Z-Factor for a gas at reference conditions.
	ENTER ↓	Z-FACTOR FLOWING #####	Enter the Z-Factor for a gas at flowing conditions.
	ENTER ↓	Advance To SETUP PULSE OUTPUT	

Sub-menus	Display	Notes	
<p>6.3.12 SETUP PULSE OUTPUT</p>	<pre> SETUP PULSE OUTPUT </pre>	<p>Press ENTER at this prompt to setup the Pulse Output.</p>	
	<p>ENTER ↓</p>	<pre> PULSE OUTPUT USAGE Off Vol CVol/Mass </pre>	<p>Select the desired Pulse Output Usage.</p>
	<p>ENTER ↓</p>	<pre> PULSE WIDTH 10mS 100mS </pre>	<p>Select the desired Pulse Width for the Pulse Output.</p>
	<p>ENTER ↓</p>	<pre> PULSE VALUE ##### gal/P </pre>	<p>Enter the desired Pulse Value for the Pulse Output (Units per Pulse).</p>
	<p>ENTER ↓</p>	<p style="text-align: center;">Advance To SETUP ANALOG OUTPUT</p>	
<p>6.3.13 SETUP ANALOG OUTPUT</p>	<pre> SETUP ANALOG OUTPUT </pre>	<p>Press ENTER when Analog is flashing to setup the Analog Output.</p>	
	<p>ENTER ↓</p>	<pre> ANALOG OUTPUT USAGE Rte Tot Tmp Den Pres </pre>	<p>Select the desired Analog Output Usage.</p>
	<p>ENTER ↓</p>	<pre> ANALOG OUT FLOW TYPE Vol CVol/Mass </pre>	<p>Only if Rate selected & Flow EQ. = Mass, Cor/Vol Select the desired Analog Output Flow.</p>
	<p>ENTER ↓</p>	<pre> ANALOG OUTPUT RANGE 4-20mA 0-20mA </pre>	<p>Select the desired current range for the Analog Output.</p>
	<p>ENTER ↓</p>	<pre> LS ANALOG OUTPUT ##### gal/m </pre>	<p>Enter desired Analog Output Low Scale Value. NOTE: Units label will correspond with output usage type selected.</p>
	<p>ENTER ↓</p>	<pre> FS ANALOG OUT 20mA ##### gal/m </pre>	<p>Enter desired Analog Output Full Scale Value.</p>
	<p>ENTER ↓</p>	<pre> ANALOG OUT DAMPING 0.0 </pre>	<p>Enter the desired Analog Output Damping Constant. Increase value to slow response time and eliminate "bounce".</p>
	<p>ENTER ↓</p>	<p style="text-align: center;">Advance To SETUP RELAYS</p>	

Sub-menus	Display	Notes
<p>6.3.14 SETUP RELAYS (Relay 1 & Relay 2)</p>	<pre> SETUP RELAYS R1y1 R1y2 R1y3 R1y4 </pre>	<p>Select the desired Relay for setup. (Relays 3 & 4 Optional)</p>
<p>NOTE: In Batch mode, Relay 1 is reserved for Preset, Relay 2 is reserved for Prewarn.</p>	<p style="text-align: center;">ENTER ↓</p>	<p>If Relay 1 or Relay 2 Selected, Select Rate, Total or NA.</p>
	<pre> RELAY 1 USAGE RATE TOTAL NA </pre>	
	<p style="text-align: center;">ENTER ↓</p>	
	<pre> RELAY 1 DELAY sec 0 </pre>	<p>If Rate selected, enter desired relay activation delay value.</p>
	<p style="text-align: center;">ENTER ↓</p>	
	<pre> RELAY 1 MODE LO_ALARM HI_ALARM </pre>	<p>Select the desired Relay Activation. Low: Relay activates when reading is below setpoint. High: Relay activates when reading is above setpoint.</p>
	<p style="text-align: center;">ENTER ↓</p>	
	<pre> RELAY 1 DURATION ##### </pre>	<p>If Total Selected, Enter desired Relay Duration.</p>
	<p style="text-align: center;">ENTER ↓</p>	
	<pre> RELAY 1 SETPOINT ##### gal </pre>	<p>Enter the desired Setpoint. The Setpoint can be edited in run mode using the PRE 1 key (PRE 2 key for Relay 2).</p>
	<p style="text-align: center;">ENTER ↓</p>	
	<pre> RELAY 1 HYSTERESIS ##### gal/m </pre>	<p>If Rate, selected, Enter desired Relay Hysteresis.</p>
	<p style="text-align: center;">ENTER ↓</p>	
	<p style="text-align: center;">Advance To SETUP RELAYS 3, 4</p>	

Sub-menus	Display	Notes
6.3.14 (Continued) SETUP RELAYS (Relay 3 & Relay 4)	<pre> SETUP RELAYS R1y1 R1y2 R1y3 R1y4 </pre>	Select the desired Relay for setup. (Relays 3 & 4 Optional)
	<pre> ENTER ↓ </pre>	
NOTE: Settings for Relays 3 & 4 may be entered even if relays are not supplied. The settings will still trigger display alarms.	<pre> RELAY 3 USAGE Rate Tot Aux Ovr NA </pre>	If Relay 3 Selected, Choose Rate, Total, Aux, Ovr or NA.
	<pre> RELAY 4 USAGE Rate Tot Aux Alrm NA </pre>	If Relay 4 Selected, Choose Rate, Total, Aux, Alrm or NA.
	<pre> ENTER ↓ </pre>	
	<pre> ASSIGN AUX CHANNEL AUX 1 AUX 2 </pre>	If Aux selected, enter desired auxilliary channel.
	<pre> ENTER ↓ </pre>	
	<pre> RELAY 3 DELAY sec 0 </pre>	If Rate / Aux selected, enter desired relay activation delay value.
	<pre> ENTER ↓ </pre>	
	<pre> RELAY 3 MODE LO_ALARM HI_ALARM </pre>	Select the desired Relay Activation for Rate/Aux. Low: Relay activates when reading is below setpoint. High: Relay activates when reading is above setpoint.
	<pre> ENTER ↓ </pre>	
	<pre> RELAY 3 DURATION ##### </pre>	If Total Selected, Enter desired Relay Duration.
	<pre> ENTER ↓ </pre>	
	<pre> RELAY 3 SETPOINT ##### gal </pre>	Enter the desired Setpoint.
	<pre> ENTER ↓ </pre>	
	<pre> RELAY 3 HYSTERESIS ##### gal/m </pre>	If Rate, selected, Enter desired Relay Hysteresis.
	<pre> ENTER ↓ </pre>	
	Advance To SETUP CONTROL INPUTS	

RELAY NOTES & CONSIDERATIONS

1. Relay activation is based on the computed readings not the displayed value. Therefore the display damping factor will not affect the relay response time. The RELAY DELAY feature allows the user to enter a time delay for relay activation. This feature is very useful in applications where short over/under range conditions are not considered alarm conditions.
2. When INSTRUMENT TYPE is set to batcher, Relay 1 is reserved for PRESET and Relay 2 is reserved for PREWARN.
3. Setting the relays to NA (Not Assigned), will allow the relay activation to be controlled via the RS-232 Serial and/or RS-485 Modbus ports.
4. Relay 3 and Relay 4 settings may be used to trigger display alarm conditions even if the relays are not supplied.

Sub-menus	Display	Notes
6.3.15 SETUP CONTROL INPUTS (RATE/TOTAL)	<pre> SETUP CONTROL INPUTS _____ [ENTER] ↓ SETUP CONTROL INPUTS Input1 Input2 Input3 _____ [ENTER] ↓ CONTROL INPUT1 USAGE INHIBIT_TOTAL NA _____ CONTROL INPUT2 USAGE RESET_TOTAL NA _____ CONTROL INPUT3 USAGE Prn Ack KeyLk NA _____ [ENTER] ↓ Advance To SETUP REALTIME CLOCK </pre>	<p>Press Enter to begin setup of the Control Inputs.</p> <p>Select the desired Control Input for setup.</p> <p>If Control Input 1 Selected, Select Inhibit Total or NA (Not Assigned).</p> <p>If Control Input 2 Selected, Select Reset Total or NA (Not Assigned).</p> <p>If Control Input 3 Selected, Select Prn (Print), Ack (acknowledge), KeyLk (Keylock) or NA (Not Assigned). ACK will acknowledge and clear alarms and warning messages.</p> <p>Note: Alarms may reassert themselves if alarm conditions are still present.</p>
6.3.16 SETUP CONTROL INPUTS (BATCH)	<pre> SETUP CONTROL INPUTS Input1 Input2 Input3 _____ [ENTER] ↓ CONTROL INPUT1 USAGE Inh Strt Rst/Strt NA _____ CONTROL INPUT2 USAGE Stop Stop/Rst NA _____ CONTROL INPUT3 USAGE Rst Prn KeyLk Ack NA _____ [ENTER] ↓ Advance To SETUP REALTIME CLOCK </pre>	<p>Select the desired Control Input for setup.</p> <p>If Control Input 1 Selected, Select Inhibit, Start,Reset/Start, NA (Not Assigned).</p> <p>If Control Input 2 Selected, Select Stop, Stop/Reset, NA (Not Assigned).</p> <p>If Control Input 3 Selected, Select Prn (Print), Ack (acknowledge), KeyLk (Keylock) or NA (Not Assigned). ACK will acknowledge and clear alarms and warning messages.</p> <p>Note: Alarms may reassert themselves if alarm conditions are still present.</p>

Sub-menus	Display	Notes	
6.3.17 SETUP REALTIME CLOCK (Time)	SETUP REALTIME CLOCK	Press Enter to begin setup of the Realtime Clock.	
	ENTER ↓	SETUP REALTIME CLOCK Time Date	Select Time to set the time.
	ENTER ↓	CLOCK TYPE 24HR 12HR	Select 24Hr or 12Hr clock
	ENTER ↓	SELECT CLOCK AM/PM AM PM	If 12Hr Clock, Enter AM or PM
	ENTER ↓	TIME OF DAY HH:MM:SS #:#:##	Enter time of day.
	ENTER ↓	Advance To SETUP REALTIME CLOCK (Date)	
6.3.18 SETUP REALTIME CLOCK (Date)	SETUP REALTIME CLOCK Time Date	Select Date to enter the date.	
	ENTER ↓	DATE: MONTH, DAY, YEAR ##/##/####	Enter the date. (Month, Day, Last two digits of Year)
	ENTER ↓	Advance To SERIAL USAGE	

<u>Sub-menus</u>	<u>Display</u>	<u>Notes</u>
6.3.19 SERIAL USAGE (RS-232/485)	SERIAL USAGE	Press Enter to begin setup of the Serial Port.
	ENTER ↓	
	SERIAL HARDWARE RS232 RS485	Select Serial Hardware type for standard port. Select RS485 only on special order. (See SETUP NETWORK CARD for RS485 Modbus option)
	ENTER ↓	
	DEVICE ID ##	Select the Device ID.
	ENTER ↓	
	BAUD RATE 300 600 1200 <more>	Select the desired Baud Rate.
	BAUD RATE 2400 4800 9600 19200	(If <more> selected)
	ENTER ↓	
	PARITY None Odd Even	Select the desired Parity.
	ENTER ↓	
	HANDSHAKING None Software Hardwre	Set the Handshake.
	ENTER ↓	
	DEVICE LINE FEED <CR> <CR+LF>	Choose end of line termination. Only choose <CR> if your external device automatically assigns a line feed for every <CR> carriage return.
	ENTER ↓	
6.3.20 SERIAL USAGE (Modem Options)	MODEM OPTIONS No Yes	Select "Yes" if the serial port will be used to control a modem.
	ENTER ↓	
	MODEM INIT MASTER No Yes	Select "Yes" to have the unit engage in a configuration conversation with the modem on power up .
	ENTER ↓	
	MODEM AUTO ANSWER No Yes	If "YES" selected for Modem Init Master, choose the desired Modem Auto Answer mode.
	ENTER ↓	
	CALL OUT DAY OF WEEK 1	Enter the day of the week to perform Call Out transmission. (0 = daily, 1 - 7 = Mon - Sun)
	ENTER ↓	
	CALL OUT TIME ##:##:##	Enter the time of day to perform Call Out transmission. (HH:MM:SS)
	ENTER ↓	

Continued on Next Page

Sub-menus	Display	Notes	
6.3.20 SERIAL USAGE (Modem Options) (continued)	CALL ON ERROR/ALARM No Yes	Select "Yes" to have the unit perform a Call Out transmission upon error/alarm condition.	
	ENTER ↓	CALL OUT PHONE # 0	Call Out Phone Number to be dialed for "Call Out Time" or "Print On Error/Alarm". (Up to 20 digits with "." used to pause between digits)
	ENTER ↓	NUMBER OF REDIALS 0	Enter the number of redials to be performed on call out time if busy or no answer (error/ alarm tries until connected).
	ENTER ↓	HANGUP IF 2MIN INACT No Yes	Select "Yes" to perform hangup if there is inactivity for more than 2 minutes.
	ENTER ↓	Advance To SETUP DATALOG/PRINT	
6.3.21 SETUP DATALOG/PRINT (Configure)	SETUP DATALOG/PRINT	Press Enter to setup the Datalog/Print information.	
	ENTER ↓	SETUP DATALOG/PRINT Config Select_list	Select Config to configure the Datalog/Print information.
	ENTER ↓	OUTPUT FORMAT Printer Term Dbase	Select the type of Output Format.
	ENTER ↓	PAGE LENGTH [99 max] 99	Enter the desired Page Length. If Printer selected above.
	ENTER ↓	TOP MARGIN [99 max] 3	Enter the desired Top Margin. If Printer selected above.
	ENTER ↓	DATALOG ONLY No Yes	Select Yes to record events to the datalogger only. Events will not be sent to the serial port.
	ENTER ↓	PRINT TIME HH:MM:SS 00:00:00	Enter Print Time, printer will print at this time every day. Enter 00:00:00 to inhibit print time.
	ENTER ↓	PRINT INTERVAL 00:00:00	Enter Print Interval, Enter 00:00:00 to inhibit print interval..
	ENTER ↓	ENABLE PRINT KEY NO YES	Select YES to enable Print Key. Select NO to disable Print Key
	ENTER ↓	CLEAR TOTAL IF PRINT NO YES	Select Yes to clear the total after printing.
	ENTER ↓	PRINT END OF BATCH NO YES	Batch mode only. Select Yes to print at end of batch.
	ENTER ↓	Advance To SETUP DATALOG/PRINT (Select_list)	

Sub-menus	Display	Notes
6.3.22 SETUP DATALOG/PRINT (Select_list)	<pre> SET DATALOG/PRINT [ENTER] SET DATALOG/PRINT Config Select_list PRINT LIST ITEMS FLUID YES PRINT LIST ITEMS TIME YES PRINT LIST ITEMS RATE YES [ENTER] PRINT LIST ITEMS DataLog size =001489 [ENTER] Advance To ADMINISTRATIVE SETUP </pre>	<p>Press enter to begin Setup Datalog/Print routine.</p> <p>Press enter when Select_list is selected to setup print list.</p> <p>Use Up and Down arrow keys to view list status. Press the Print or function key for the items that you wish to add or remove from the list. Items marked with Yes will be added to the list, items marked with No will be removed from the list.</p> <p>The Select Print List Information display shows the current possible Datalog size.</p>
<p>List Items:</p> <ul style="list-style-type: none"> FLUID TIME RATE TOTAL GRAND TEMP DENS PRE1 PRE2 PRESS VISC FREQ1 FREQ2 KA-F KB-F 		
6.3.23 ADMINISTRATIVE SETUP	<pre> ADMINISTRATIVE SETUP [ENTER] TAG NUMBER FT XXXX [ENTER] OPERATOR PASSWORD ***** [ENTER] SUPERVISOR PASSWORD ***** [ENTER] SOFTWARE VERSION Vxx.xxx [ENTER] PRODUCT ORDER CODE ES747xxxxxxxxx [ENTER] UNIT SERIAL NUMBER 00000 [ENTER] SENSOR SERIAL NUMBER 00000 [ENTER] DISPLAY NEW ERR ONLY No Yes [ENTER] Advance To SETUP NETWORK CARD </pre>	<p>Press Enter to begin Administrative Setup.</p> <p>Use the up and down arrow keys to define the tag number.</p> <p>Enter Operator Password. (Factory Set to 0)</p> <p>Enter Supervisor Password, if logged in as supervisor. (Factory Set to 2000)</p> <p>This display is used to show the software version of the installed software.</p> <p>This display is used to show the product order code (model number).</p> <p>This display is used to show the unit's serial number.</p> <p>This display is used to show the sensor's serial number.</p> <p>If yes is selected, an error message will only appear once until acknowledged by user.</p> <p>Advance to Network Card only if a Network Card is installed.</p>

6.3.24
**SETUP
 NETWORK CARD
 (optional)**

```
SETUP NETWORK CARD
```

Press Enter to setup Network Card

ENTER ↓

```
SELECT NTW PROTOCOL
ModbusRTU
```

Select desired Network Protocol.

ENTER ↓

```
NETWORK DEVICE ID
1
```

Enter the device address on network (00-255).

ENTER ↓

```
BAUD RATE
2400 4800 9600 19200
```

Select the desired Baud Rate.

ENTER ↓

```
PARITY
None      Odd      Even
```

Select the desired Parity.

ENTER ↓

```
Advance To
INSTRUMENT TYPE
```

7. Principle Of Operation

General Operation

7.1 General:

The ES-747 Flow Computer uses several internal calculations to compute the compensated flow based on specific data input. Several computations are performed to arrive at the uncompensated flow, temperature, pressure, density and viscosity. This information is then used to compute the Corrected Volume Flow or Mass Flow.

Note concerning Fluid Information

The user will be prompted for Fluid Information during the setup of the instrument. The unit can store the fluid properties for up to 10 different fluids at one time. See also Appendix A for common fluid properties for liquids and gases.

Flow Equations

7.2 Flow Equations:

Input Temperature Computation:

General Case

$$T_f = [\% \text{ input span} \cdot (\text{temp FS} - \text{Temp low scale})] + \text{temp low scale}$$

RTD Case

$$T_f = f(\text{measured input resistance})$$

Input Density Computation:

Density Transmitter

$$\text{density} = [\% \text{ input span} \cdot (\text{density FS} - \text{density low scale})] + \text{density low scale}$$

Input Pressure Computation:

General Case

$$P_f = [\% \text{ input span} \cdot (\text{pressure FS} - \text{Pressure Low Scale})] + \text{Pressure Low Scale}$$

Gauge Case

$$P_f = P_f + \text{Barometric}$$

Manual Case or In Event of Fault

$$P_f = \text{Pressure Default Value}$$

Fluid Properties:

Liquid Generic Case

$$\text{liquid density} = \text{reference density} \cdot (1 - (\text{Therm. Exp. Coef.} \times 10^{-6} (T_f - T_{\text{ref}}))^2)$$

Liquid API Case

$$\text{liquid density} = \text{reference density} \cdot (\text{VCF API2540})$$

Gas Case

$$\text{gas density} = \text{reference density} \cdot \frac{P_f}{P_{\text{ref}}} \cdot \frac{T_{\text{ref}}}{T_f} \cdot \frac{Z_{\text{ref}}}{Z_f}$$

Where flowing and reference temperature and pressure are in absolute scale.

7.2 Flow Equations: (Continued)

Fluid Equations

Viscosity Computation:

Liquid Case

$$\dagger \text{ centistokes} = \frac{\left(A \exp \frac{B}{(\text{Deg F} + 459.67)} \right)}{\text{Absolute Density}}$$

Where: centistokes = cP/(kg/l)

Gas Case

$$\text{cP viscosity} = A \cdot (T_f + 459.67)^B$$

Uncompensated Flow Computation:

Pulse Input: Average K-Factor

$$\text{Volume Flow} = \frac{\text{input frequency} \cdot \text{time scale factor}}{\text{K-Factor}}$$

Pulse Input: Linear Table

$$\text{Volume Flow} = \frac{\text{input frequency} \cdot \text{time scale factor}}{\text{K-Factor (Hz)}}$$

Pulse Input: UVC Table

$$\text{Volume Flow} = \frac{\text{input frequency} \cdot \text{time scale factor}}{\text{K-Factor (Hz/cstk)}}$$

Pulse Input: Strouhal/Roshko Table

$$\text{Volume Flow} = \frac{\text{input frequency} \cdot \text{time scale factor}}{\text{Strouhal Cal} / (1 + 3 \cdot \text{meter exp coeff.} \cdot 10^{-6} (T_f - T_{cal}))}$$

$$\text{Roshko Cal} = \frac{\text{input frequency} \cdot (1 + 2 \cdot \text{meter exp coeff.} \cdot 10^{-6} (T_f - T_{cal}))}{\text{cstk}}$$

Corrected Volume Flow Computation:

Liquid Case

Temperature Transmitter

$$\text{Standard Volume Flow} = \text{volume flow} \cdot (1 - \text{Therm.Exp.Coeff.} \cdot (T_f - T_{ref}))^2$$

Density Transmitter

$$\text{Standard Volume Flow} = \text{volume flow} \cdot \frac{\text{density}}{\text{reference density}}$$

Gas Case

$$\text{std. volume flow} = \text{volume flow} \cdot \frac{P_f}{P_{ref}} \cdot \frac{(T_{ref} + 459.67)}{(T_f + 459.67)} \cdot \frac{Z_{ref}}{Z_f}$$

Mass Flow Computation:

$$\text{Mass Flow} = \text{volume flow} \cdot \text{density}$$

7.2 Flow Equations: (Continued)

Flow Equations

API 2540 Equation. The American Petroleum Institute, in a joint program with the National Bureau of Standards (NIST), developed a density equation based on 463 samples of five different oil products. The results of this work are incorporated into Chap. 11.1, "Volume Correction Factors," of API Standard 2540 (1987).

The density equation is based on the thermal-expansion coefficient of the product at 60°F (15.6°C) base temperature, which is calculated from the base density as

$$\alpha_b = \frac{K_0}{\rho_b^{*2}} + \frac{K_1}{\rho_b^*} \quad (2.188)$$

where the base density ρ_b^* is in kilograms per cubic meter. The empirically derived constants K_0 and K_1 for the five product groups are given in Table 2.23. The density of the product at flowing temperature is then calculated as

$$\rho_F^* = \rho_b^* \exp [-\alpha_b \Delta T_F (1 + 0.8 \alpha_b \Delta T_F)] \quad (2.189)$$

where $\Delta T_F = T_F - 60$. The specific gravity at flowing or measured temperature is then

TABLE 2.23 Constants K_0 and K_1 for Five Product Groups

Product group	K_0	K_1
Crude oils and JP4†	341.0957	0.0
Jet fuels, kerosenes, solvents	330.3010	0.0
Gasolines and naphthenes	192.4571	0.2438
Lubricating oils	144.0427	0.1895
Diesel oil, heating oils, fuel oils	103.8720	0.2701

Note: Pentanes and hydrocarbons lower in the hydrocarbon chain are *not* covered by this data.

†API News Release 1987 added JP4.

The above information was obtained from "Flow Measurement Engineering Handbook, 3rd Edition" by Richard W Miller.

API 2540 Expansion Factor Equation

1. Select the values for K_0 and K_1 for the fluid group to be measured
2. Convert the base reference density for your fluid into the corresponding density units of kg/m^3
3. Solve for α_b using equation above
4. $C = \alpha_b \cdot 1,000,000$

7.3 Calculating the Fluid Expansion Factor

Calculating Expansion Factor

The liquid density is a function of the flowing temperature for many fluids. This unit solves an equation which represents this physical property of the fluid.

The information which the unit uses to describe the fluid is entered by the user in the following variables: Reference Temperature, Reference Density, Fluid Expansion Factor. Values for common fluids are listed in Appendix A

This information is available for many fluids in one or more of the following forms:

Fluid Specific Gravity vs. Temp. Table

Specific Gravity vs. Temp. Graph

Fluid Density vs. Temp. Table

Fluid Density vs. Temp. Graph

Begin by obtaining one of the fluid properties for the fluid you are using from available manufacturers information or Engineering Handbooks. In some cases this information is listed on the Material Safety Data Sheet for the fluid.

Two temperature-specific gravity pairs will be required to compute the temperature coefficient.

The reference temperature is simply chosen by the user. Common reference temperatures are 60° F or 15° C.

However, for cryogenic fluids, the normal boiling point may also be used. In some cases the fluid data may list properties at 100° F, this temperature may also be used as the reference temperature.

The reference temperature should be chosen so that it is in the application temperature range. i.e. application temperature range -10 to 120° F, reference temperature of 60° F chosen.

Enter the reference temperature you have chosen at this point.

The reference specific gravity corresponds to the fluid SPECIFIC GRAVITY at the reference temperature chosen.

You may convert the fluid density information to specific gravity if it is in units other than specific gravity. Use EQ1.

Expansion Factor Equations

EQ1.

$$\text{Spec.Grav.} = \text{Density of Fluid} / \text{Density of Water}$$

Given the reference temperature, reference specific gravity, a second temp. and a second Spec.Grav., the Expansion Factor (C Factor) can be computed as follows:

EQ2. Used for Liquid Mass and Corrected Volume Equations

$$C = \left[\frac{1 - \sqrt{(\text{Spec.Grav.2} / \text{Ref.Spec.Grav.})}}{\text{Temp.2} - \text{Ref.Temp}} \right] \times 1,000,000$$

Given the reference temperature, reference density, a second temp. and a second density, the Expansion Factor (C Factor) can be computed as follows:

EQ3. Used for Liquid Mass and Corrected Volume Equations

$$C = \left[\frac{1 - \sqrt{(\text{Dens.2} / \text{Ref.Dens.})}}{\text{Temp.2} - \text{Ref.Temp}} \right] \times 1,000,000$$

C = Fluid Expansion Factor

7.4 Computation of Viscosity Coef. A and B

Computation of Viscosity Coef. A & B

The flow computer solves an equation which computes the viscosity as a function of temperature. Two parameters must be entered for this calculation to be performed. These are the setup parameters Viscosity Coef. A and Viscosity Coef. B. A table listing these values for common fluids is available in Appendix A.

Alternately, if your intended fluid is not listed, the Viscosity Coef. A and B can be derived from two known temperature/viscosity pairs. Begin by obtaining this information for your intended fluid. Convert these known points to units of Degrees F and centipoise (cP)

The information is now in a suitable form to compute the Viscosity Coef. A and Viscosity Coef. B using the following equation based on the fluid state.

For a liquid, A and B are computed as follows:

$$B = \frac{(T1 + 459.67) \cdot (T2 + 459.67) \cdot \ln [cP1/cP2]}{(T2 + 459.67) - (T1 + 459.67)}$$

$$A = \frac{cP1}{\exp [B / (T1 + 459.67)]}$$

$$\text{NOTE: } cS = \frac{cP \cdot \text{Density of Water at } 4^{\circ}\text{C}}{\text{Density of Fluid at Flowing Conditions}}$$

For a gas, A and B are computed as follows:

$$B = \frac{\ln [cP2 / cP1]}{\ln (T2 + 459.67) / (T1 + 459.67)}$$

$$A = \frac{cP1}{(T1 + 459.67)^B}$$

$$\text{NOTE: } cS = \frac{cP \cdot \text{Density of Water at } 4^{\circ}\text{C}}{\text{Density of Fluid at Flowing Conditions}}$$

7.5 Linearization Table

Linearization Table General Information

7.5.1 Linearization Table General Information

The Linearization Table is used when the flow input device gives a nonlinear input signal. The unit uses up to 40 different points, as entered by the operator, to form a curve for linearizing the input signal.

Notes:

- 1) A minimum of three points must be set up.
- 2) If "0" is entered for the frequency of any point other than point 1, the Flow Computer assumes there are no more points above the points that preceded them. The display will advance to the next setup prompt.
- 3) If the input frequency is above the highest or below the lowest frequency programmed, the unit will use the last known point for the K factor in computing the resulting actual flow.
- 4) Frequencies, Hz/Cstks or Roshko numbers should be entered in ascending order.

Linearization Table (Pulse Inputs)

7.5.2 Linearization Table for Pulse Inputs

The linearization table for pulse inputs programming is quite simple when values of frequency and flow are known. The Flow Computer asks for 40 different frequencies (Freq) and 40 corresponding K factors (K). It then uses this data to determine what the actual flow is for any given input frequency. Usually the necessary data is provided with the flowmeter.

Linearization Table Interpolation

7.5.3 Linearization Table Interpolation

The Linearization Table routine uses the entered data to determine the K factor for any given input frequency or input flow signal. This is done by taking the closest data points above and below the input signal, then using those points to interpolate the K factor, then calculating the uncompensated flow from the data. Below are the formulas.

Parameters:

Determine closest point above input signal
 signal = X, K factor (correction factor) = KA

Determine closest point below input signal
 signal = Y, K factor (correction factor) = KB

Let input signal = H,
 unknown K factor (correction factor) = KN

To find KN use this formula:

$$\frac{H - Y}{X - Y} \times (KA - KB) + KB = KN$$

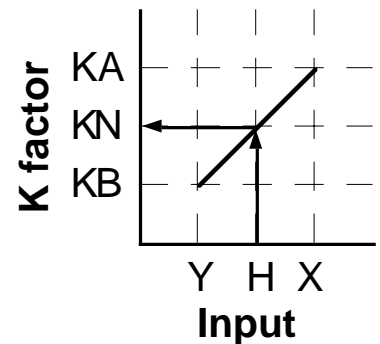

Universal Viscosity Curve

7.6 Universal Viscosity Curve (UVC)

A Universal Viscosity Curve is a presentation of the calibration of a turbine flowmeter's K-Factor as a function of the Hz/cstks. It is used to represent the combined effects of flowrate and viscosity on the calibration of the flowmeter. It is entered as a table of point pairs in ascending order of Hz/cstks.

Strouhal Roshko Curve

7.7 Strouhal Roshko Curve (StRo)









A Strouhal Roshko Curve is a presentation of the calibration of a turbine flowmeter's calibration as a table or curve of Strouhal number as a function of Roshko number. It is used to represent the combined effects of flowrate, flowing temperature and viscosity on the calibration of the turbine flowmeter. It is entered as a table of point pairs in ascending order of Roshko numbers.

8. Test, Service and Maintenance

8.1 Test Menus

Menu	Display	Notes
8.1.1 TOP LEVEL TEST MENU	<pre>SELECT OPERATE STATE Run Setup Test</pre> <p style="text-align: center;">ENTER ↓</p>	<p>Select Test to enter the instrument test & calibration routine. NOTE: Supervisor (Service) password required to gain access to this mode.</p>
	<p style="text-align: center;">▲ START</p> <pre>Audit Trail</pre> <p style="text-align: center;">STOP ↓ ↑ START</p>	Refer to Page 48 for Details.
	<pre>Error history</pre> <p style="text-align: center;">STOP ↓ ↑ START</p>	Refer to Page 48 for Details.
	<pre>Print System Setup</pre> <p style="text-align: center;">STOP ↓ ↑ START</p>	Refer to Page 48 for Details.
	<pre>Keypad Test</pre> <p style="text-align: center;">STOP ↓ ↑ START</p>	Refer to Page 49 Details.
	<pre>Display test</pre> <p style="text-align: center;">STOP ↓ ↑ START</p>	Refer to Page 49 for Details.
	<pre>Calibrate</pre> <p style="text-align: center;">STOP ↓ ↑ START</p>	Refer to Pages 50-54 for Details.
	<pre>Analog In Test</pre> <p style="text-align: center;">STOP ↓ ↑ START</p>	Refer to Page 54 Details.
	<pre>Pulse input test</pre> <p style="text-align: center;">STOP ↓ ↑ START</p>	Refer to Page 55 for Details.
	<pre>Analog out test</pre> <p style="text-align: center;">STOP ↓ ↑ START</p>	Refer to Page 55 for Details.
	<pre>Excitation out test</pre> <p style="text-align: center;">STOP ↓ ↑ START</p>	Refer to Page 55 for Details.
	<pre>Pulse out test</pre> <p style="text-align: center;">STOP ↓ ↑ START</p>	Refer to Page 56 for Details.
	<pre>Relay Test</pre> <p style="text-align: center;">STOP ↓ ↑ START</p>	Refer to Page 56 for Details.
	<pre>Control inputs test</pre> <p style="text-align: center;">STOP ↓ ↑ START</p>	Refer to Page 56 for Details.
	<pre>Battery Voltage Test</pre> <p style="text-align: center;">STOP ↓ ↑ START</p>	Refer to Page 57 for Details.
	<p style="text-align: center;">STOP ↓</p> <pre>Data logger utility</pre>	Refer to Page 57 for Details.



8.2 Test Sub-Menus

<u>Sub-menus</u>	<u>Display</u>	<u>Notes</u>	
8.2.1 Audit Trail Submenu Group	<pre>Audit Trail</pre>	Press Enter to view the audit trail information.	
		The configuration audit trail format: nnnnn= number of critical menu changes, hh:mm:ss; mm/dd/yy = time and date of last change.	
	<pre>Config_Audit nnnnn hh:mm:ss mm/dd/yy</pre>	The calibration audit trail format: nnnnn= number of calibration changes, hh:mm:ss; mm/dd/yy = time and date of last change.	
		<pre>Cal_Audit nnnnn hh:mm:ss mm/dd/yy</pre>	
	<pre>Audit Trail</pre>	Press Menu to get back to audit trail top-level menu.	
8.2.2 Error History Submenu Group	<pre>Error history</pre>	Press Enter to view error history. NOTE: Press Print Key to print Error History. Printout will include time/date of each errors first occurrence.	
		<pre>Error history Flow rate alarm low</pre>	Press Up/Down arrow keys to scroll through error message history. Press CLEAR to clear entire error log.
		<pre>Error history</pre>	Press Menu to get back to error history top=level menu.
8.2.3 Print System Setup Submenu Group	<pre>Print System Setup</pre>	Press enter key to enter print system setup submenu	
		<pre>Print System Setup Press ENTER to print</pre>	Press enter to begin printing the system setup.
		<pre>Print System Setup -- Printing ---</pre>	This message will display as the data transmission takes place.
		<pre>Print System Setup</pre>	Press Menu to get back to print system setup top-level menu.

<u>Sub-menus</u>	<u>Display</u>	<u>Notes</u>
8.2.4 Keypad test Submenu Group	<div style="border: 1px solid black; padding: 5px; text-align: center;">Keypad test</div>	Press Enter to enter keypad test
	<div style="text-align: center; margin-bottom: 5px;"> ENTER ↓ </div> <div style="border: 1px solid black; padding: 5px; text-align: center;"> Keypad test Key pressed-> ENT </div>	Press the various keys and the display will show the key that was pressed. Press Menu to exit the test
	<div style="text-align: center; margin-bottom: 5px;"> MENU ↓ </div> <div style="border: 1px solid black; padding: 5px; text-align: center;">Keypad test</div>	Press Menu to get back to Keypad test top-level menu.
8.2.5 Display test Submenu Group	<div style="border: 1px solid black; padding: 5px; text-align: center;">Display test</div>	Press Enter to enter display test.
	<div style="text-align: center; margin-bottom: 5px;"> ENTER ↓ </div> <div style="border: 1px solid black; padding: 5px; text-align: center;"> <pre> 000000000000000000000000 000000000000000000000000 </pre> </div>	Upon pressing enter, each digit on the display will scroll 0-9 then A-Z. Press menu to exit the test.
	<div style="text-align: center; margin-bottom: 5px;"> MENU ↓ </div> <div style="border: 1px solid black; padding: 5px; text-align: center;">Display test</div>	Press Menu to get back to Display test top-level menu.

ALL UNITS ARE CALIBRATED AT THE FACTORY PRIOR TO SHIPMENT
CAUTION:
 This unit must be calibrated using precision and calibrated equipment.
 Equipment needed is as follows: Frequency Generator, Digital Multimeter,
 Precision Current/Voltage Source, Oscilloscope, Frequency Counter.

<u>Sub-menus</u>	<u>Display</u>	<u>Notes</u>
Calibration Submenu Group	<div style="border: 1px solid black; padding: 5px; display: inline-block;">Calibrate</div>	Press Enter to begin the calibration routine. (Please note the caution above)
	<div style="border: 1px solid black; padding: 2px; display: inline-block;">ENTER</div> ↓	
8.2.6 Calibrate Aux1: 0mA Submenu Group	<div style="border: 1px solid black; padding: 5px; display: inline-block;">Calibrate Aux1: 0mA Iin=TB1-7 GND=TB1-4</div>	Connect Current Source (+) TB1-7, (-) TB1-4. Input 0mA and press Enter.
	<div style="border: 1px solid black; padding: 2px; display: inline-block;">ENTER</div> ↓	
	<div style="border: 1px solid black; padding: 5px; display: inline-block;">Calibrate Aux1: 0mA CALIBRATING --</div>	This message is displayed during calibration.
	↓	
	<div style="border: 1px solid black; padding: 5px; display: inline-block;">Calibrate Aux1: 0mA *** DONE ***</div>	This message is displayed when the 0mA calibration is finished.
	↓	
	<div style="border: 1px solid black; padding: 5px; display: inline-block;">Calibrate Aux1: 0mA Iin=TB1-7 GND=TB1-4</div>	The display will automatically return to the Calibrate Aux1 0mA submenu. Press the Down arrow key to advance to the Aux1 20mA calibration.
	<div style="border: 1px solid black; padding: 2px; display: inline-block;">STOP</div> ↓	
8.2.7 Calibrate Aux1: 20mA Submenu Group	<div style="border: 1px solid black; padding: 5px; display: inline-block;">Calibrate Aux1: 20mA Iin=TB1-7 GND=TB1-4</div>	Connect Current Source (+) TB1-7, (-) TB1-4. Input 20mA and press Enter.
	<div style="border: 1px solid black; padding: 2px; display: inline-block;">ENTER</div> ↓	
	<div style="border: 1px solid black; padding: 5px; display: inline-block;">Calibrate Aux1: 20mA 0 CALIBRATING --</div>	This message is displayed during calibration.
	↓	
	<div style="border: 1px solid black; padding: 5px; display: inline-block;">Calibrate Aux1: 20mA *** DONE ***</div>	This message is displayed when the 20mA calibration is finished.
	↓	
	<div style="border: 1px solid black; padding: 5px; display: inline-block;">Calibrate Aux1: 20mA Iin=TB1-7 GND=TB1-4</div>	The display will automatically return to the Calibrate Aux1 20mA submenu. Press the Down arrow key to advance to the Aux2 0mA calibration.
	<div style="border: 1px solid black; padding: 2px; display: inline-block;">STOP</div> ↓	
	Advance to Calibrate Aux2: 0mA	

Sub-menus	Display	Notes
8.2.8 Calibrate Aux2: 0mA Submenu Group	<pre>Calibrate Aux2: 0mA Iin=TB1-8 GND=TB1-4</pre>	To Calibrate: Connect Current Source (+) TB1-8, (-) TB1-4. Input 0mA and press Enter.
		This message is displayed during calibration.
	<pre>Calibrate Aux2: 0mA 0 CALIBRATING --</pre>	This message is displayed when the 0mA calibration is finished.
	<pre>Calibrate Aux2: 0mA *** DONE ***</pre>	The display will automatically return to the Calibrate Aux2 0mA submenu. Press the Down arrow key to advance to the AUX2 20mA calibration.
8.2.9 Calibrate Aux2: 20mA Submenu Group	<pre>Calibrate Aux2: 0mA Iin=TB1-8 GND=TB1-4</pre>	
		To Calibrate: Connect Current Source (+) TB1-8, (-) TB1-4. Input 20mA and press Enter.
	<pre>Calibrate Aux2: 20mA Iin=TB1-8 GND=TB1-4</pre>	This message is displayed during calibration.
	<pre>Calibrate Aux2: 20mA 0 CALIBRATING --</pre>	This message is displayed when the 20mA calibration is finished.
<pre>Calibrate Aux2: 20mA *** DONE ***</pre>	The display will automatically return to the Calibrate Aux2 20mA submenu. Press the Down arrow key to advance to the thermistor 100Ω calibration.	
<pre>Calibrate Aux2: 20mA Iin=TB1-8 GND=TB1-4</pre>		Advance to Cal Therm: 100 Ohms

8.2.10
Cal Therm: 100
Ohms
Submenu Group

```
Cal Therm: 100 Ohms
Therm TB1-6 to TB1-4
```



To Calibrate: Place a 100 ohm 0.1% resistor between TB1-6 and TB1-4. Press enter to calibrate.

```
Cal Therm: 100 Ohms
 0 CALIBRATING --
```

This message is displayed during calibration.



```
Cal Therm: 100 Ohms
*** DONE ***
```

This message is displayed when the calibration is finished.



```
Cal Therm: 100 Ohms
Therm TB1-6 to TB1-4
```

The display will automatically return to the Cal Therm: 100 Ohms top-level menu. Press the Down arrow key to advance to the Thermistor Open calibration.



Advance to
Cal Therm: Open

8.2.11
Cal Therm: Open
Submenu Group

```
Cal Therm: Open
Therm TB1-6 to TB1-4
```



To Calibrate: Remove the 100Ω 0.1% resistor from TB1-6 and TB1-4 and leave open. Press enter to calibrate.

```
Cal Therm: Open
 0 CALIBRATING --
```

This message is displayed during calibration.



```
Cal Therm: Open
*** DONE ***
```

This message is displayed when the calibration is finished.







```
Cal Therm: Open
Therm TB1-6 to TB1-4
```









The display will automatically return to the Cal Therm Open top-level menu. Press the Down arrow key to advance to the Aux2: 0V calibration.



Advance to
Calibrate Aux2: 0V

Sub-menus	Display	Notes
8.2.12 Calibrate Aux2: 0V Submenu Group	<pre>Calibrate Aux2: 0V Vin=TB1-5 GND=TB1-4</pre>	To Calibrate: Connect Voltage Source (+) TB1-5, (-) TB1-4. Input 0V and press Enter.
		This message is displayed during calibration.
	<pre>Calibrate Aux2: 0V 0 CALIBRATING --</pre>	This message is displayed during calibration.
	<pre>Calibrate Aux2: 0V *** DONE ***</pre>	This message is displayed when the 0V calibration is finished.
8.2.13 Calibrate Aux2: 10V Submenu Group	<pre>Calibrate Aux2: 0V Iin=TB1-5 GND=TB1-4</pre>	The display will automatically return to the Calibrate Aux2 0V top-level menu. Press the Down arrow key to advance to the Aux2 10V calibration.
		To Calibrate: Connect Voltage Source (+) TB1-5, (-) TB1-4. Input 10V and press Enter.
	<pre>Calibrate Aux2: 10V Iin=TB1-5 GND=TB1-4</pre>	This message is displayed during calibration.
	<pre>Calibrate Aux2: 10V 0 CALIBRATING --</pre>	This message is displayed when the 10V calibration is finished.
<pre>Calibrate Aux2: 10V *** DONE ***</pre>	The display will automatically return to the Calibrate Aux2 10V top-level menu. Press the Down arrow key to advance to the 100 ohm RTD calibration.	
<pre>Calibrate Aux2: 10V Iin=TB1-5 GND=TB1-4</pre>		Advance to Cal RTD 100ohm
8.2.14 Calibrate 100 ohm RTD Submenu Group	<pre>Cal RTD 100ohm JMP TB1-6,7 100R=7,8</pre>	To Calibrate: Connect a jumper wire between TB1-6 and TB1-7, Place a 100 ohm 0.1% resistor between TB1-7 and TB1-8. Press enter to calibrate.
		This message is displayed during calibration.
	<pre>Cal RTD 100ohm 0 CALIBRATING --</pre>	This message is displayed when the RTD calibration is finished.
	<pre>Cal RTD 100ohm *** DONE ***</pre>	The display will automatically return to the Calibrate 100 ohm RTD top-level menu. Press the Down arrow key to advance to the 0mA analog out calibration.
<pre>Cal RTD 100ohm JMP TB1-6,7 100R=7,8</pre>		Advance to Calibrate 0mA Aout

Sub-menus	Display	Notes
8.2.15 Calibrate 0mA Aout Submenu Group	Calibrate 0mA Aout + TB1-15 - TB1-16	Connect ammeter to (+) TB1-15, (-) TB1-16. Press enter.
	<div style="text-align: center;"> ENTER ↓ </div> Calibrate 0mA Aout Enter mA: 0.00000	To trim 0mA analog output: Press CLEAR to enable editing and enter a small negative number (i.e. -0.100) to force a display reading, then clear and enter small quantity measured on your meter.
	<div style="text-align: center;"> ENTER ↓ </div> Calibrate 0mA Aout + TB1-15 - TB1-16	The display will return to Calibrate 0mA out. Press the down arrow key to advance to the 20mA analog out or repeat above if necessary.
8.2.16 Calibrate 20mA Aout Submenu Group	Calibrate 20mA Aout + TB1-15 - TB1-16	Connect ammeter to (+) TB1-15, (-) TB1-16. Press enter.
	<div style="text-align: center;"> ENTER ↓ </div> Calibrate 20mA out Enter mA: 20.00000	To trim 20mA analog output: Press CLEAR to enable editing and enter the current reading that is on the ammeter display. Press enter.
	<div style="text-align: center;"> ENTER ↓ </div> Calibrate 20mA Aout + TB1-15 - TB1-16	The display will automatically return to the Calibrate 20mA Aout submenu. Calibration is complete.
	<div style="text-align: center;"> MENU ↓ </div> Calibrate	Press the Menu key to go back to Calibrate top-level menu.
8.2.17 Analog In Test Submenu Group	Analog In Test	Press enter to test the analog inputs.
	<div style="text-align: center;"> ENTER ↓ </div> Analog In Test Volts T5:00.000	To check voltage input accuracy: Use TB1-4 as Reference Ground, input 0-10 Volts to TB1-5. Display should show voltage being input. Use voltage meter to verify input.
	<div style="text-align: center;"> STOP ↓ </div> Analog In Test mA T7:00.000 T8:00.000	To check current input accuracy: Use TB1-4 as Reference Ground, input 0-20mA to TB1-7 and/or TB1-8. Display should show current being input. Use ammeter to verify input.
	<div style="text-align: center;"> STOP ↓ </div> Analog In Test Ohms Therm:100.000	To check RTD input accuracy: Connect a jumper wire between TB1-6 and TB1-7, Place a 100 ohm 0.1% resistor between TB1-7 and TB1-8. Display should show 100 ohms ±0.1%.
<div style="text-align: center;"> MENU ↓ </div> Analog In Test	Press Menu key to return to Analog In Test top-level menu.	

Sub-menus	Display	Notes
8.2.18 Pulse input test Submenu Group	<div style="border: 1px solid black; padding: 5px; text-align: center;">Pulse input test</div> <div style="text-align: center; margin: 5px 0;">  </div> <div style="border: 1px solid black; padding: 5px; text-align: center;"> Pulse input test Trigger level 2.5V </div> <div style="text-align: center; margin: 5px 0;">  </div> <div style="border: 1px solid black; padding: 5px; text-align: center;"> Pulse input test count speed 3kHz </div> <div style="text-align: center; margin: 5px 0;">  </div> <div style="border: 1px solid black; padding: 5px; text-align: center;"> Pulse input test F1: 0 F2: 0 </div> <div style="text-align: center; margin: 5px 0;">  </div> <div style="border: 1px solid black; padding: 5px; text-align: center;">Pulse input test</div>	<p>Press Enter key to test the pulse input.</p> <p>Use the Up/Down arrow keys to select the appropriate trigger level.</p> <p>Use the Up/Down arrow keys to select the appropriate frequency range.</p> <p>To check Pulse input accuracy at the above settings: Use TB1-4 as reference ground, input a frequency on TB1-2 and/or TB1-3. The display should show frequency being input. Use a frequency counter to verify input.</p> <p>Press Menu key to return to Pulse input test top-level menu.</p>
8.2.19 Analog out test Submenu Group	<div style="border: 1px solid black; padding: 5px; text-align: center;">Analog out test</div> <div style="text-align: center; margin: 5px 0;">  </div> <div style="border: 1px solid black; padding: 5px; text-align: center;"> Analog out test *0 4 10 15 20 mA </div> <div style="text-align: center; margin: 5px 0;">  </div> <div style="border: 1px solid black; padding: 5px; text-align: center;">Analog out test</div>	<p>Press Enter to test the analog output.</p> <p>To simulate analog output: Connect an ammeter to (+) TB1-15, (-) TB1-16. Press the key under the desired setting to move the asterisk (*). The unit should output the selected current.</p> <p>Press Menu key to return to Analog out test top-level menu.</p>
8.2.20 Excitation out test Submenu Group	<div style="border: 1px solid black; padding: 5px; text-align: center;">Excitation out test</div> <div style="text-align: center; margin: 5px 0;">  </div> <div style="border: 1px solid black; padding: 5px; text-align: center;"> Excitation out test *5v 12v 24v </div> <div style="text-align: center; margin: 5px 0;">  </div> <div style="border: 1px solid black; padding: 5px; text-align: center;">Excitation out test</div>	<p>Press Enter to test the excitation output.</p> <p>To test the excitation output: Connect a voltmeter to (+) TB1-1, (-) TB1-4. Press the key under the desired setting to move the asterisk (*). The unit should output the selected voltage.</p> <p>Press Menu key to return to Excitation out test top-level menu.</p>

Sub-menus	Display	Notes
8.2.21 Pulse out test Submenu Group	<pre>Pulse out test</pre> <p style="text-align: center;">ENTER ↓</p> <pre>Pulse out test *0Hz 1Hz 10Hz 20Hz</pre> <p style="text-align: center;">MENU ↓</p> <pre>Pulse out test</pre>	<p>Press Enter key to test the pulse output.</p> <p>To simulate a frequency on the pulse output: Connect a frequency counter to (+)TB1-13, (-)TB1-14. Press the key under the desired setting to move the asterisk (*). The unit should output the selected frequency.</p> <p>Press Menu key to return to Pulse out test top-level menu.</p>
8.2.22 Relay test Submenu Group	<pre>Relay Test</pre> <p style="text-align: center;">ENTER ↓</p> <pre>R1y1 R1y2 R1y3 R1y4 Off Off Off Off</pre> <p style="text-align: center;">MENU ↓</p> <pre>Relay Test</pre>	<p>Press Enter to test the relays.</p> <p>To manually control the relay outputs: Press the key under the desired relay to toggle the relays On/Off. Use an ohmmeter to check the relay contacts.</p> <p>Press Menu key to return to Relay Test top-level menu.</p>
8.2.23 Control input test Submenu Group	<pre>Control inputs test</pre> <p style="text-align: center;">ENTER ↓</p> <pre>TB1-9 TB1-10 TB1-11 Off Off Off</pre> <p style="text-align: center;">MENU ↓</p> <pre>Control inputs test</pre>	<p>Press Enter to test the control inputs.</p> <p>To check the control inputs: Use TB1-12 as reference, input a positive 3-30 VDC signal to TB1-9, TB1-10 and/or TB1-11, The Display will show ON when input is active, OFF when inactive.</p> <p>Press Menu key to return to control input test top-level menu.</p>

Sub-menus	Display	Notes
8.2.24 Battery Voltage test Submenu Group	<div style="border: 1px solid black; padding: 5px; text-align: center;">Battery Voltage Test</div>	Press Enter key to view the battery voltage.
	<div style="border: 1px solid black; padding: 2px; text-align: center;">ENTER ↓</div>	
	<div style="border: 1px solid black; padding: 5px; text-align: center;">Battery Voltage Test 3.312 Volts</div>	The display will show the battery voltage. Replace battery at 2.5 VDC or below.
	<div style="border: 1px solid black; padding: 2px; text-align: center;">MENU ↓</div>	
	<div style="border: 1px solid black; padding: 5px; text-align: center;">Battery Voltage Test</div>	Press Menu key to return to battery voltage test top-level menu.
8.2.25 Data logger utility Submenu Group	<div style="border: 1px solid black; padding: 5px; text-align: center;">Data logger utility</div>	Press Enter to use data logger utility.
	<div style="border: 1px solid black; padding: 2px; text-align: center;">ENTER ↓</div>	
	<div style="border: 1px solid black; padding: 5px; text-align: center;">Data logger utility Log 10 958 Max</div>	The displays shows the number of Data Logs. Press the Down arrow key to advance to PRT (print) or CLR (clear).
	<div style="border: 1px solid black; padding: 2px; text-align: center;">STOP ▼</div>	
	<div style="border: 1px solid black; padding: 5px; text-align: center;">Data logger utility Log 00001 PRT CLR</div>	Press PRINT key to output data logger logs to printer, Press CLEAR key to clear the data logger contents.
	<div style="border: 1px solid black; padding: 2px; text-align: center;">MENU ↓</div>	
	<div style="border: 1px solid black; padding: 5px; text-align: center;">Data logger utility</div>	Press Menu key to return to Data logger utility top-level menu.

8.3 Internal Fuse Replacement

Instructions:

1. Make sure you follow proper E.S.D. Precautions. All persons performing this replacement must follow proper grounding procedures.
2. Turn the power to the unit off.
3. Disconnect the two piece connector rear terminal block, leaving all connections in place.
4. Remove the unit from the panel.
5. Remove the four machine screws (see fig. 1) which hold the two sections of the case together.
6. The rear section of the case should detach from the rest of the case. It may be necessary to cut the wiring label along the joint where the two sections connect. With the rear section of the case removed the fuse will be exposed (located near the rear terminal, AC connection).
7. Locate the Fuse F1 (see fig. 2) and unplug the fuse from its socket.
8. Insert the new fuse into the socket. Insure that the pins are fully inserted and straight.
9. Reassemble the case and install the four machine screws which join the two sections of the case.
10. Reinstall the unit into the panel.
11. Reconnect the rear terminal block.
12. Turn the unit back on.

Fuse Specifications:

- | | | |
|------------------|----------------|-----------------------------------|
| 110 VAC Power: | 160mA/250V, TD | Wickman 19372-030-k or equivalent |
| 220 VAC Power: | 80mA/250V, TD | Wickman 19372-026-k or equivalent |
| 12/24 VDC Power: | 800mA/250V, TD | Wickman 19374-046-k or equivalent |

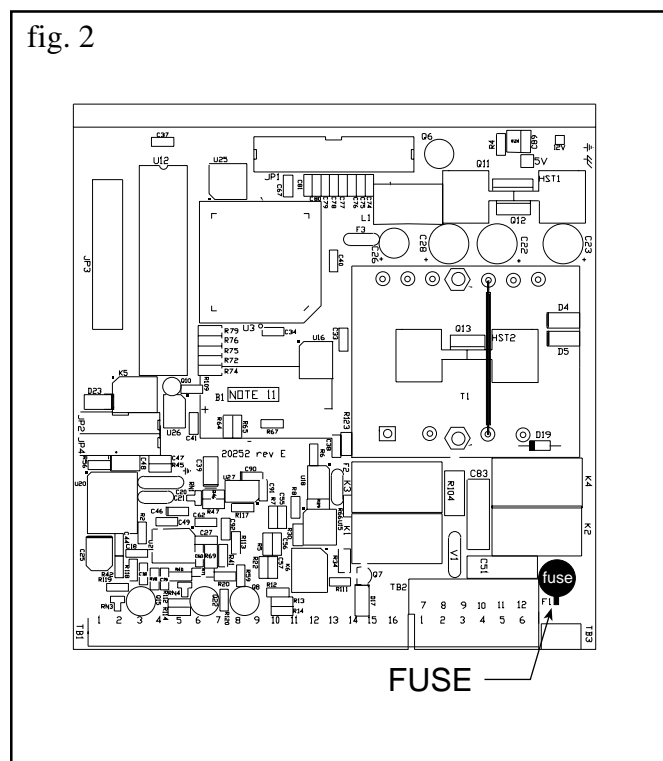
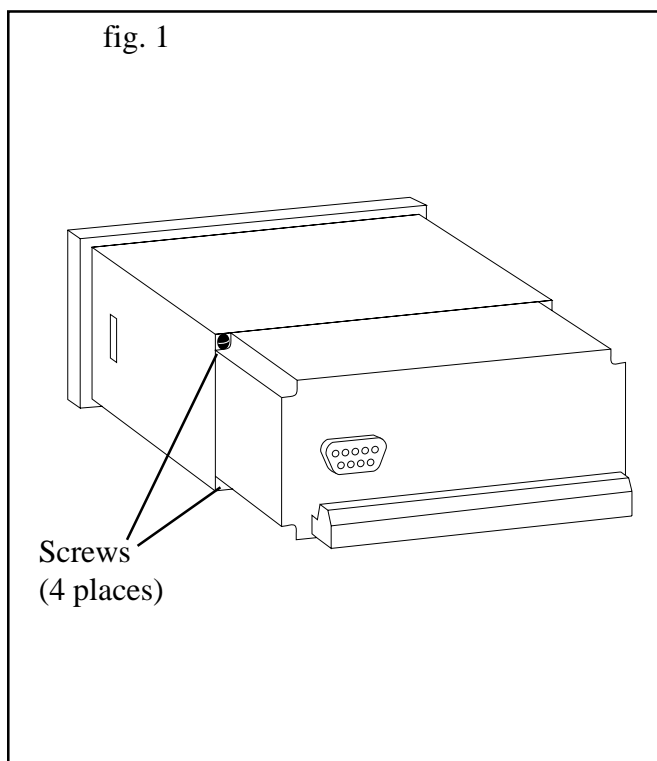

9. RS-232 Serial Port

9.1 RS-232 Port Description:

The ES-747 has a general purpose RS-232 Port which may be used for any one of the following purposes:

- Transaction Printing
- Data Logging
- Remote Metering by Modem (optional)
- Computer Communication Link
- Configuration by Computer
- Print System Setup
- Print Calibration/Malfunction History

9.2 Instrument Setup by PC's over Serial Port

A Diskette program is provided with the ES-747 that enables the user to rapidly configure the ES-747 using a Personal Computer. Included on the diskette are common instrument applications which may be used as a starting point for your application. This permits the user to have an excellent starting point and helps speed the user through the instrument setup.

9.3 Operation of Serial Communication Port with Printers

ES-747's RS-232 channel supports a number of operating modes. One of these modes is intended to support operation with a printer in metering applications requiring transaction printing, data logging and/or printing of calibration and maintenance reports.

For transaction printing, the user defines the items to be included in the printed document. The user can also select what initiates the transaction print generated as part of the setup of the instrument. The transaction document may be initiated via a front panel key depression, a remote contact closure, or upon completion of a batch.

In data logging, the user defines the items to be included in each data log as a print list. The user can also select when or how often he wishes a data log to be made. This is done during the setup of the instrument as either a time of day or as a time interval between logging.

The system setup and maintenance report list all the instrument setup parameters and usage for the current instrument configuration. In addition, the Audit trail information is presented as well as a status report listing any observed malfunctions which have not been corrected.

The user initiates the printing of this report at a designated point in the menu by pressing the print key on the front panel.

9.4 ES-747 RS-232 Port Pinout

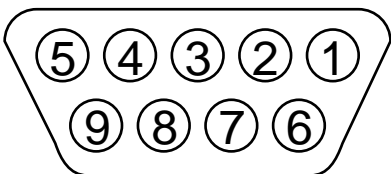

- 1 Handshake Line
- 2 Transmit
- 3 Receive
- 4 Do Not Use
- 5 Ground
- 6 Do Not Use
- 7 Do Not Use
- 8 Do Not Use
- 9 Do Not Use

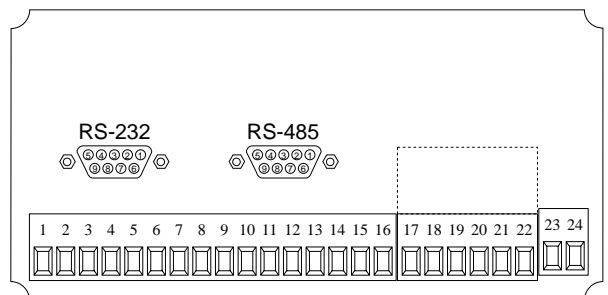

10. RS-485 Serial Port (optional)

10.1 RS-485 Port Description:

The ES-747 has a an optional general purpose RS-485 Port which may be used for any one of the following purposes:

Accessing Process Parameters

Rate, Temperatures, Density, Pressure, Viscosity, Setpoints, Month, Day, Year, Hour, Minutes, Seconds, etc.

Accessing System Alarms

System, Process, Self Test, Service Test Errors

Accessing Totalizers

Totalizer and Grand Totalizer

Executing Various Action Routines

Reset Alarms, Reset Totalizers, Print Transaction, Reset Error History, Start, Stop, Clear

10.2 General

The optional RS-485 card utilizes Modbus RTU protocol to access a variety of process parameters and totalizers. In addition, action routines can be executed. For further information, contact factory and request RS-485 Protocol manual for ES-747.

10.3 Operation of Serial Communication Port with PC

The flow computer's RS-485 channel supports a number of Modbus RTU commands. Refer to port pinout (below) for wiring details. Modbus RTU drivers are available from third party sources for a variety of Man Machine Interface software for IBM compatible PC's.

The user reads and writes information from/to the RS-485 using the Modbus RTU commands. The ES-747 then responds to these information and command requests.

Process variables and totalizers are read in register pairs in floating point format. Time and date are read as a series of integer register values. Alarms are individually read as coils. Action routines are initiated by writing to coils.

10.4 ES-747 RS-485 Port Pinout

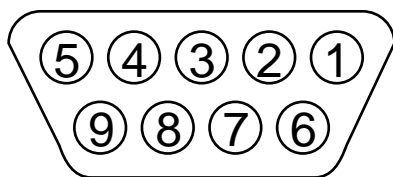

- 1 Ground
- 2 Ground
- 3 Ground
- 4 TX/RX (+)
- 5 TX/RX (-)
- 6 Do Not Use
- 7 Terminating Resistor (180 Ω)
- 8 TX/RX (+)
- 9 TX/RX (-)

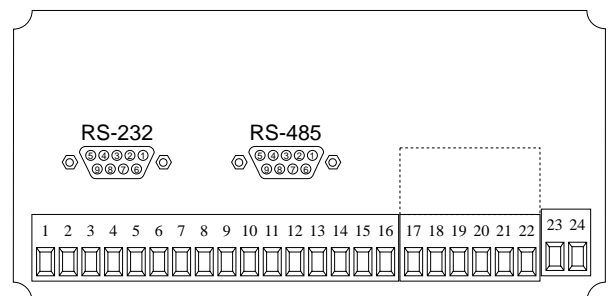

NOTE: To terminate cable end, connect Pin 7 to either Pin 4 or Pin 8.

11. Flow Computer Setup Software

The ES-747 setup program provides for configuring, monitoring and controlling a ES-747 unit over the RS-232 link.

Sample applications are stored in disk files. The setup program calls these *Templates*. You can store the setup from the program's memory to either the ES-747 (*Downloading* the file) or to a disk file (*Saving* the file) for later usage. Similarly you can load the setup in program memory from either a disk file (*Opening* a file) or from the ES-747 unit (*Uploading* a file).

The program can monitor outputs from the unit while it is running.

The program can reset alarms and totalizers.

For assistance there are mini-helps at the bottom of each screen in the program. There is also context sensitive help available for each screen accessible by pressing the F1 key.

11.1 System Requirements:

IBM PC or compatible with 386 or higher class microprocessor

4 MB RAM

3 MB free disk space

VGA or higher color monitor at 640 x 480

Microsoft® Windows™ 3.1 or 3.11 or Windows 95™

Communication Port - RS-232

RS-232 Cable

11.2 Cable and Wiring Requirements:

The serial communication port on your PC is either a 25 pin or 9 pin connector. No cabling is supplied with the setup software. A cable must be purchased separately or made by the user. It is recommended to purchase a cable which matches the available communication port on you PC and a 9 pin male connection for the ES-747 serial port.

11.3 Installation for Windows™ 3.1 or 3.11

The Setup Software includes an installation program which copies the software to your hard drive.

Insert Setup Disk 1 in a floppy drive.

In the Program Manager, click File, and then select Run.

NOTE: For Windows 95™ Click the Start button, select Run and proceed as follows:

Type the floppy drive letter followed by a colon (:), and a backslash (\), and the word setup. For Example:

a:\setup

Follow the instructions on your screen.

11.4 Using the Flow Computer Setup Software

The setup software window consists of several menu “Tabs”. Each tab is organized into groups containing various configuration and/or monitoring functions. To view the tab windows, simply click on the tab. The previous tab window will be hidden as the new tab window is brought to the foreground.

11.5 File Tab

The File Tab has three sections. Any of the options on this tab can also be accessed from the File submenu.

The **Template Section** provides for opening and saving templates. The *Save* and *Save As* buttons provide the standard Windows functionality for dealing with files. The *Open* button is used to open existing templates or files.

There are two additional menu items available *only* from the pull down File menu: *Open existing file* and *Templates*.

The *Open existing file*, option allows for creating custom templates using the existing template in memory as the starting point. Assign a new name for this template. The template will be saved under this new name.

The *Open Template* option will bring up a list of predefined templates that can be loaded into the program. These predefined templates are useful as a starting point when defining custom templates.

A typical scenario using the setup program would be the following:

- Open up a predefined template from the supplied list
- Choose ‘Save As’ to save this to a new file name
- Proceed to customize the template by making any changes that are needed
- Save the setup to disk (if you want to reuse this template)
- Download the template to an attached unit.

The **Communications with ES-747 Section** allows the user to upload the setup from the unit or download the setup to the unit.

The **Print (report) Section** allows the user to:

1. Configure the current Windows printer through the Select Printer option.
2. Print a Maintenance Report through the PC's printer using the Print Maintenance option.
3. Print the current setup through the PC's printer using Print Setup option.

11.6 Setup Tab

The Setup tab is where majority of the ES-747 instrument setup modifications are done. The Setup tab is divided into five sections.

System Section: Flow Equation, Indicators

Input Section: Flow, Fluid, Compensation Inputs 1 & 2, Control Inputs

Output Section: Pulse, Currents

Relay Section: Relays

Other Settings Section: Administration, Communication, Datalog #Printing, Time & Date

NOTE: Many setup items are enabled or disabled depending on previous setup selections, It is important to work your way through the above list in the order shown. Be sure to verify your selections when you are through programming to insure that no settings were changed automatically.

11.7 View Tab

The View Tab screen allows for viewing selected group items on the PC in a similar format as shown on the unit display. Data from the following groups can be viewed in the List of Values section:

Process Parameters (i.e. rate, temperature)

Totalizers (i.e. total, grand total)

Error Log

Software Version

The setup software assumes the current setup has been uploaded from the flow computer into the PC. It is important that the setup program and the ES-747 unit are using the same setup information at all times or the data will be inconsistent. It is best to upload or download the setup before using this feature.

To start the viewer, first check the boxes of items to view and then click the start button. The data will appear in the appropriate sections and will be continuously updated. The refresh rate is dependent on the number of items that are being viewed and the baud rate of the connection. Data in the List of Values section can be collapsed by clicking on the 'minus' sign in front of the group title. The data can be expanded by clicking on the 'plus' sign in front of the group title. If a group is collapsed and data in the group changes on refresh, the group will automatically expand. Changing the view items requires stopping the current viewing, checking the new selections and then restarting the viewer.

If communication errors occur while reading data from the ES-747 device, the word 'Error' will appear in place of the actual value. If the connection to the ES-747 is lost, the viewer will time out with a message saying the device is not responding.

The viewer will attempt to communicate with the ES-747 device matching the device ID set in the communications screen. If you are having trouble establishing communication, compare settings for the PC and the flow computer. Also verify the connections between the PC and flow computer.

11.8 Misc. Tab

This tab has three sections: Tools, Actions and Options.

The tools section contains various system administration activities such as creating/modifying the initial sign-on screen.

Create Sign-on and Create Print Header

The Actions section is used to send commands to the ES-747 unit.

Reset Totalizers, Reset Alarms, Reset Alarm History

The Options section has the following selections:

Network Card Setup

Additional capabilities may be provided in the future.

NOTE: Future options appear as disabled buttons on the screen.

12. Glossary Of Terms

Acknowledge & Clear Alarms

Acknowledge is used to clear alarm relays and remove any visual alarm messages from the display. In the run mode, press the ENTER key or activate CONTROL INPUT 3 (if set for *ACK*) to momentarily clear alarms and alarm messages. Alarms will reassert themselves if alarm conditions are still present.

Analog Output

The analog signal (4-20mA) that is generated by the ES-747. It can correspond to the Rate, Total, Temperature, Pressure or Density. This output is used primarily for transmission of process information to remote systems.

Audit Trail

The audit trail is used to track the number of changes made to the units setup program.

Auto Batch Restart

The Auto Batch Restart function allows the user to set an amount of time to automatically restart a batch after the completion of a batch. This time can be set from 1 to 99 seconds.

Barometric Pressure

An entry of the average, local atmospheric pressure at the altitude or elevation of the installation. (typically 14.696 psia)

Batch Count Mode

Batch Count Mode specifies the user preference for count direction. The "*Up*" selection begins with a value of "0" and counts up until the batch size is reached. The "*Down*" selection begins with a value equal to the desired batch size and counts down to "0".

Batch Overrun

The ES-747 offers a batch overrun compensation routine. If batch overrun occurs due to slow valve response time, the unit will compensate for the overrun amount on the next batch. This feature can be disabled if desired.

Batcher

An instrument which controls the dispensing of desired batch amounts. Liquid batching systems are usually comprised of a batch controller (batcher), flowmeter and control valve. The batcher opens and closes the valve through the use of relays and measures the amounts of liquid being dispensed via the flowmeter.

Baud Rate

The speed of serial communication transmissions, expressed in bits per second.

Calibration Temperature

The temperature at which a flow sensor was calibrated on a test fluid.

C-Factor (Fluid Expansion Factor)

A parameter in a flow equation which is used to describe the relationship between density or volume and temperature changes.

Corrected Volume Flow

The equivalently volume at a reference temperature condition which involves the measurement of liquid volume flow using a flow sensor and temperature sensor to compensate for thermal expansion.

Custody Transfer

Weights and Measure metering codes often specify several requirements for instruments and mechanisms to prevent and track changes in the setup of an instrument which may be used in the commercial sale of goods. The ES-747 tracks changes via the Audit Trail.

Data Logger

The capturing of information for later use and the mechanism for specifying the conditions where a capture should be made.

DC Output / Excitation Voltage

An on-board DC power supply used to power peripheral sensors. The ES-747 offers excitation voltages of 5VDC, 12VDC or 24VDC when powered by AC voltage.

Default Value

The value to be used by the instrument if a sensor failure or out of range signal is detected.

Expansion Factor

See C-Factor

Flow Alarm

A visual indication that the volumetric flowrate is above or below the flow alarm setpoint specified by the user.

12. Glossary Of Terms (Continued)

Flow Equation

A recognized relationship between the process parameters for flow, temperature, pressure and density used in flow measurements.

Flow Signal Timeout

The Flow Signal Timeout allows the user to enter a timeout of 0 to 99 seconds. If a batch is "Filling" and zero flow persists for more than the user entered time then the batch will be aborted. This prevents over flows due to faulty flow sensors and/or wiring.

Flowing Z-Factor

The mean Z-Factor under flowing conditions of temperature and pressure for a specific gas.

Follow, Alarm

Alarm relays which are non latching and whose output state is based solely on the comparison of the current process value and the alarm setpoint (trip point).

Function Key

A key on a push-button panel or keyboard (whose function is described by the key label) used to perform an instrument function or special routine.

Handshake

A means of controlling the information flow between two pieces of equipment to prevent the sending device from transmitting information at a rate faster than what can be accepted by the receiver.

Gas Cor. Vol Eq.

An equation where the corrected volume flow of gas at STP is computed from measured volume flow, temperature and pressure as well as stored gas properties.

Gas Mass Eq.

An equation where the mass flow of a gas is computed from measured volume flow, temperature and pressure as well as stored gas properties.

Hysteresis

The relay hysteresis is a "dead band" setting which allows the relay to remain energized for a given amount below the setpoint. This is used to prevent relay chatter when the process value is near the setpoint value.

Example: If the Preset is set at 100, and the hysteresis is set at 10, the relay will energize when the rate, temp or dens. reaches 100, the relay will remain energized until the reading falls below 90.

Input Termination

Input signal lines on digital inputs often require pullup or pulldown resistor configurations to operate properly with different sensor configurations. The ES-747 contains such resistors and may be enabled via the setup menu.

Inlet Pipe Bore

The internal pipe diameter upstream of the flow measurement element.

Inhibit Totalizer

"*Inhibit Total*" is a Control Input 1 setting that is used to stop the totalization. If enabled, a voltage level on control input 1 will inhibit the total as long as the voltage is present. This feature is useful during meter proving and in applications that provide a sensor to signal the flow computer when fluid is present.

K-Factor

A scaling factor derived from the pulses produced by a flowmeter output, expressed in pulses per unit (i.e. pulses/gallon)

Limit Setpoint

An alarm trip point setting which specifies the value or magnitude of a process parameter necessary to activate an alarm indicator or control relay.

Linear Flowmeter

A flow measurement device whose output is proportional to flow.

Linearization

The mathematical correction of a nonlinear device. The ES-747 uses a linearization Table which is made up of input/output values and makes interpolations of the table to arrive at a "linearized" measurement.

LinTbl

Abbreviation for Linearization Table.

Low Pass Filter

A low pass filter passes low input frequencies while blocking high frequencies. In the ES-747, this is the maximum input count speed to be encountered in an application. It is expressed in counts per second (Hz).

12. Glossary Of Terms (Continued)

Mass Flow

Mass Flow is inferred by the volumetric flow and density (or implied density) of a fluid.

Maximum Batch Preset

The Maximum Batch Preset allows the user to program the Maximum Batch value allowed to be entered by the operator. If an operator should try to program a batch higher than this value, the unit will not allow the value to be entered and will prompt the user with an error message saying that the Maximum Batch Preset has been exceeded.

Maximum Drain Time

The unit declares that a batch is "done" when the flow rate equals "0". A flow rate may be present long after the Preset Relay de-energizes due to slow reacting valves or leaky valves. The Maximum Drain Time allows the user to enter an amount of time (0 to 99 seconds) to wait before declaring "Batch Done". After the Preset Batch quantity is reached, the unit will declare "Batch Done" when the flow rate is "0" or the Maximum Drain Time has expired. The batch data will then be available for printing and datalogging.

Max Window

The max. window time sets the maximum sample time (1 to 99 sec) for the ratemeter.

Meter Expansion Coef.

A coefficient in an equation which may be used to correct for changes in flowmeter housing dimensional changes with temperature.

Modem Init Master

The "Modem Init Master" menu allows the user to select whether the unit will engage in a configuration conversation with the modem on power up or impart no setup information to the modem and use it "as is". For most users it is recommended to choose "yes" for "Modem Init Master".

Parity

A method for detecting errors in transmissions of serial communications data.

Preset

A set point used to trigger the relay outputs of the ES-747.

Print Interval

The print interval allows the ES-747 to transmit information to the serial port at selectable time intervals.

Private Code

An operator password code which authorizes changes to the setup of the instrument but blocks access to the Service/Calibration/Test mode. The private code also blocks the clearing of the Grand Total.

Process Parameters

Any sensor information which has been scaled to engineering units including Flow, Temperature, Pressure and Density.

Pulldown (Input Termination)

The termination of an input at which the input is pulled down to ground through a resistor. Inputs that are terminated by this method need to be driven high with a positive voltage pulse.

Pullup (Input Termination)

The termination of an input at which the input is pulled up to a positive voltage through a resistor. Inputs that are terminated by this method need to be pulled low with a sinking current or contact to ground.

Pulse Output

The pulse output of the ES-747 is available for remote accumulation of the total or sent to peripheral devices, such as a PLC. The output can be scaled using the Pulse Output Scaling Constant.

Quad

Abbreviation for Quadrature. Quadrature signals are used for direction control. Two flowmeter signals are output with a 90° phase shift. The counter counts UP when channel A precedes channel B, and counts DOWN when Channel A lags Channel B.

Quick Setup

A utility that provides for rapid configuration of an instrument. The ES-747 quick setup provides the following:

- 1) Prompts the user for only critical information.
- 2) Automatically sets specifications to common uses.

After following the Quick Setup procedure, the unit will be operational to perform the basic measurement. The setup can be further customized using the setup menus.

12. Glossary Of Terms (Continued)

Quick Update %

This feature is used to disable the rate averaging filter when a significant change in the flow rate occurs. The user can enter the percent of change needed to be detected to disable the averaging feature. This is especially useful during start-up and shutdown of flow.

Rate Averaging Filter

The rate averaging filter is used to stabilize fluctuating rate displays. Higher settings provide more averaging for a more stable display. Derived from the equation:

$$\frac{(\text{OLD DATA} \times \text{"Avg. Filter"} + \text{NEW DATA})}{(\text{"Avg. Filter"} + 1)}$$

Ratometer

Any device used to display the speed of a process. The ratemeter in the ES-747 displays flow rate.

Ref. Dens.

Abbreviation for Reference Density. This is the fluid density at reference conditions of temperature and pressure.

Ref. Temp.

Abbreviation for Reference Temperature. This represents the base or reference condition to which corrected flow will be computed.

Ref. Z-Factor

Abbreviation for Reference Z-Factor. The Z-Factor for a gas at reference conditions of temperature and pressure.

Reset/Start Control Input

In a batching system, a single operator activation of the START key or Control Input 1 will reset the total then start the batch process.

Roshko

A parameter defined as: $R_o = \frac{f \cdot \text{temperature correction}}{cst_k}$

Single_Pulse

The Single_Pulse setting is used for flowmeters with single pulse outputs.

Slow Start Quantity

The Slow Start Quantity is a function that allows an amount to be entered for a Slow Start up. This function requires two stage valve control. RLY 1 (slow flow) will energize for Slow Start and RLY 2 (fast flow) will energize after the Slow Start Quantity has been delivered. This helps reduce turbulence when filling an empty container.

Stop/Reset Control Input

In a batching system, a single operator activation of the STOP key or Control Input 2 will stop the batch process then reset the total.

STP Reference

The users desired pressure and/or temperature to be considered as the reference condition in the computation of fluid properties or corrected volume conditions.

Strouhal

A calibration parameter defined as temperature corrected K-factor for a turbine flowmeter.

Time Constant

A damping factor for an averaging filter for the analog output. (see also Rate Averaging Filter)

Totalizer

Any device which accumulates and displays a total count.

UVC

Abbreviation for Universal Viscosity Curve. A presentation of the combined flowrate/viscosity calibration for a turbine flowmeter.

VFD

Abbreviation for Vacuum Fluorescent Display

Visc Coef

Abbreviation for Viscosity Coefficient. One or more coefficients in an equation used to describe the viscosity as a function of temperature for a fluid.

Volume Flow

The measurement of volumetric flow.

13. Diagnosis and Troubleshooting

13.1 Response of ES-747 on Error or Alarm:

Error and warning indications which occur during operation are indicated in the RUN mode alternately with the measured values. The ES-747 Flow Computer has three types of error:

TYPE OF ERROR	DESCRIPTION
Sensor/Process Alarms	Errors detected due to sensor failure or process alarm conditions
Self Test Errors	Errors detected during self test.
System Alarms	Errors detected due to system failure

Some alarms are self clearing. Other alarms require the user to acknowledge and clear the alarm. Press the ENTER button to acknowledge and clear alarms. Alarms may reassert themselves if the alarm condition is still present.

NOTE: A historical error alarm log is available in the "Test Mode".

The following descriptions suggest possible causes and corrective actions for each alarm message.

13.2 Diagnosis Flow Chart and Troubleshooting

All instruments undergo various stages of quality control during production. The last of these stages is a complete calibration carried out on state-of-the-art calibration rigs.

A summary of possible causes is given below to help you identify faults.

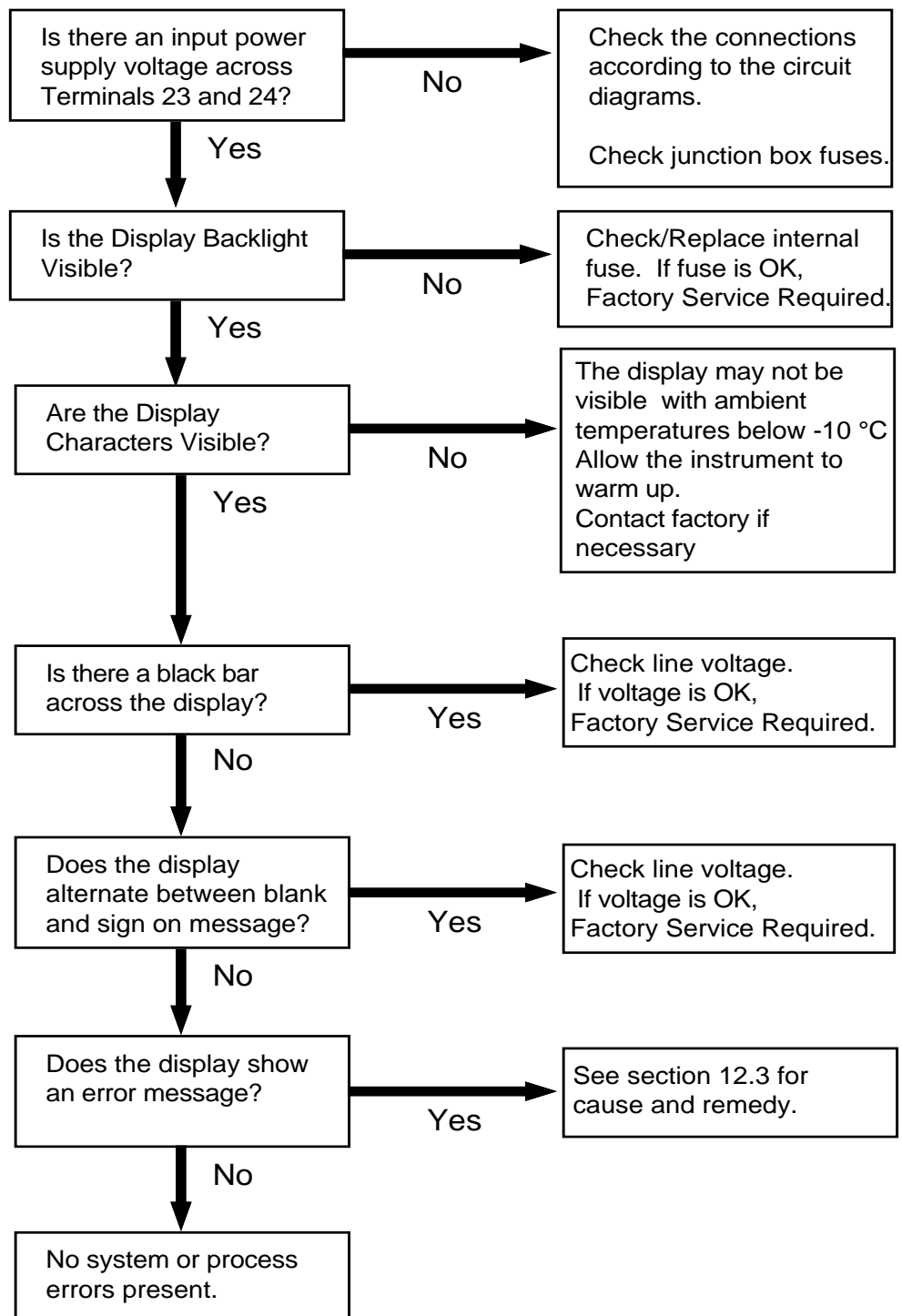

13.3 Error & Warning Messages:

13.3.1 Sensor/Process Alarms

Error/Warning Message	Cause	Remedy
TOTALIZER ROLLOVER	Displayed when totalizer rolls over	Acknowledge Rollover, Remedy not required
AUX INPUT TOO LOW!	4-20 mA Input current at aux input smaller than 3.5 mA: <ul style="list-style-type: none"> • Faulty Wiring • Transmitter not set to "4-20 mA" • Transmitter defective 	<ul style="list-style-type: none"> • Check wiring • Check function of sensor
RTD OUT OF RANGE	Input current at RTD input too low: <ul style="list-style-type: none"> • Faulty wiring • RTD defective 	<ul style="list-style-type: none"> • Check wiring • Check function of RTD sensor
RATE OVERFLOW ERROR	Pulse counter overflowed. The totalizer may have lost counts.	<ul style="list-style-type: none"> • Report error to factory • Check application conditions • Check wiring
PULSE OUT OVERFLOW	Calculated pulse frequency too large: <ul style="list-style-type: none"> • Pulse width setting too long • Larger pulse scaler needed 	<ul style="list-style-type: none"> • Adjust pulse value • Adjust pulse width • Check process conditions
FLOW RATE ALARM LOW FLOW RATE ALARM HIGH TEMP ALARM LOW TEMP ALARM HIGH DENSITY ALARM LOW DENSITY ALARM HIGH PRESSURE ALARM LOW PRESSURE ALARM HIGH	Limit value exceeded.	<ul style="list-style-type: none"> • Check application if necessary • Check limit value • Adjust the limit value if required
BATCH OVERRUN ALARM	Batch size exceeded by more than set limit.	<ul style="list-style-type: none"> • Check valves in system for proper operation and/or leaks • Check limit value • Adjust the limit value if required
MODEM NOT PRESENT	The setup expects modem usage and a modem is not responding.	<ul style="list-style-type: none"> • Check setup for proper baud rate, parity, etc. • Check modem connection and cycle power to the unit. • Replace modem
SOFTWARE ERROR RESET	The setup expects modem usage and a modem is not responding.	<ul style="list-style-type: none"> • Report error to factory
EXTENDED PFI LOCKUP	Unit was operated with an input power level lower than safe operating range for an extended period of time.	<ul style="list-style-type: none"> • Check data in unit. Totalizer may have inaccuracies • Investigate brownout cause.

13.3 Error & Warning Messages: (Continued)

13.3.2 Self Test Alarms

Error/Warning Message	Cause	Remedy
AUX INPUT TOO HIGH!	Analog input signal of the auxiliary input exceeded by more than 3%: <ul style="list-style-type: none"> • Sensor overranged • Incorrect full scale setting of transmitter • Function error in transmitter or faulty wiring 	<ul style="list-style-type: none"> • Check analog signal range • Check the application conditions • Check wiring
BATTERY LOW WARNING	Battery voltage too low	<ul style="list-style-type: none"> • Replace Battery • Consult Factory for service information
A to D NOT CONVERTING	Fault in analog/digital converter	<ul style="list-style-type: none"> • Unit may self correct, Press ENTER to acknowledge & clear alarm • If error reasserts, factory service is required
TIME CLOCK ERROR	The correct time/date is no longer shown	<ul style="list-style-type: none"> • Re-enter time and date. • If error occurs again contact factory
CAL CHECKSUM ERROR	Calibration constants have been corrupted	<ul style="list-style-type: none"> • Report error to factory
SETUP CHECKSUM ERROR	The units setup has been corrupted	<ul style="list-style-type: none"> • Report error to factory
RTD/THERM FAILURE	Input current at RTD or Thermistor input too low: <ul style="list-style-type: none"> • Faulty wiring • RTD/Thermistor defective 	<ul style="list-style-type: none"> • Check wiring • Check function of RTD/Thermistor sensor

Appendix A**Fluid Properties Table****LIQUID**

FLUID	REF. DENSITY (lb./gal)	REF. TEMP. (°F)	COEFF. OF EXPANSION (e-6 format)	LIQ.VISC. ANDREDE's EQUATION COEFF. "A"	VISCOSITY BY ANDREDE's EQUATION COEFF. "B"
AIR	7.2947	-317.8	1626.2	0.172	0
AMMONIA	5.6996	-28.2	570.4	0.00157	2228.25
ARGON	11.6172	-302.6	1486.1	0.011291	511.34
CO2	8.735	-10.0	1260.9	0.000001	5305.44
METHANE	3.5404	-258.7	1052.3	0.006819	526.08
NATURAL GAS	3.5404	-258.7	1052.3	0.006819	526.08
NITROGEN	6.7438	-320.4	1491.7	0.006524	434.94
OXYGEN	9.5208	-297.4	1345.8	0.019773	340.29
PROPANE	4.2344	60	717.8	0.009969	1267.35
Nx-19	3.5404	-258.7	1052.3	0.006819	526.08
GASOLINE	6.2572	60	370.3	0.045617	1432.26
KEROSENE	6.9243	60	268.1	0.004378	3245.78
No. 2 FUEL	7.8843	60	88.5	0.000453	4946.15
WATER	8.3389	60	101.5	0.001969	3315.61

GAS

FLUID	REF. DENSITY (lb./ft³)	REF. TEMP. (°F)	REF. Z FACTOR (14.696 PSIA)	Z FACTOR AT 100 PSIA and 60°F	VISCOSITY BY ANDREDE's EQUATION COEFF. "A"	VISCOSITY BY ANDREDE's EQUATION COEFF. "B"
AIR	0.076	60	1	0.997	0.000138	0.775522
AMMONIA	0.045	60	1	0.955	0.000013	1.05951
ARGON	0.105	60	1	0.995	0.00021	0.750757
CO2	0.116	60	1	0.954	0.000049	0.91136
METHANE	0.042	60	1	0.970	0.000018	1.015892
NAT. GAS	0.0456	60	1	0.970	0.000018	1.015892
NITROGEN	0.074	60	1	0.998	0.000202	0.7128734
OXYGEN	0.084	60	1	0.995	0.000169	0.761811
PROPANE	0.116	60	1	0.870	0.00002	0.952092
Nx-19	0.0456	60	1	0.97	0.000018	1.015892

Appendix B

START HERE

INSTRUMENT TYPE	BATCH COUNT MODE	MAX. BATCH PRESET	BATCH OVERRUN COMP.	AUTO BATCH RESTART	TIME DELAY	FLOW SIGNAL TIMEOUT	MAX. DRAIN TIME	SLOW START QUANTITY	NOT TOT FOR BATCH DELAY				
SELECT FLOW EQUATION	CHOOSE FLUID MEDIUM	SELECT FLOW EQUATION			TEMPERATURE SCALE	TEMPERATURE DEC PLACES	TEMPERATURE DEFAULT	PRESSURE UNITS	PRESSURE DESCRIPTOR	PRESSURE DEC PLACES	PRESSURE DEFAULT	BAROMETRIC PRESSURE	
SETUP INDICATORS	SETUP INDICATORS	TOTAL DESCRIPTOR	VOLUME UNITS	DENSITY DESCRIPTOR	MASS UNITS	DENSITY DEC PLACES	DENSITY DEFAULT	RATE TIME BASE	RATE DESCRIPTOR	RATE DEC PLACES	RATE AVERAGE FILTER	QUICK UPDATE %	TEMP DESCRIPTOR
SETUP FLOW INPUT	EXCITATION VOLTAGE	PULSE INPUT TYPE	PULSE TRIGGER TYPE	LOW PASS FILTER	INPUT TERMINATION	K-FACTOR TYPE	AVERAGE KA-FACTOR	AVERAGE KB-FACTOR	CHANGE TABLE A	CHANGE TABLE B	LOW FLOW RATE ALARM	HIGH FLOW RATE ALARM	METER EXPANSION
SETUP AUX1 INPUT	AUX1 INPUT TYPE	AUX1 SIGNAL RANGE	CURRENT RANGE	AUX LOW SCALE	AUX FULL SCALE	OFFSET TEMPERATURE	AUX HIGH ALARM	DENS EXTRACT METHOD					CALIBRATION TEMPERATURE
SETUP AUX2 INPUT	AUX2 INPUT TYPE	VOLTAGE RANGE	CURRENT RANGE	AUX LOW SCALE	AUX FULL SCALE	AUX LOW ALARM	AUX HIGH ALARM	DENS EXTRACT METHOD					H2O DENSITY AT 4DEGC
SET FLUID PROPERTIES	FLUID NUMBER	FLUID NAME	REF. DENSITY	REF. TEMPERATURE	EXPANSION FACTOR	VISCOSITY COEF. A	VISCOSITY COEF. B	REFERENCE PRESSURE	Z-FACTOR FLOWING				
SETUP PULSE OUTPUT	PULSE OUTPUT USAGE	PULSE WIDTH	PULSE VALUE										
SETUP ANALOG OUTPUT	ANALOG OUTPUT USAGE	ANALOG OUTPUT FLOW TYPE	ANALOG OUTPUT RANGE	ANALOG OUTPUT LOW SCALE	ANALOG OUTPUT FULL SCALE	ANALOG OUTPUT DAMPING							
SETUP RELAYS	SETUP RELAYS 1, 2, 3, 4	RELAY USAGE	ASSIGN AUX CHANNEL	RELAY DELAY	RELAY DURATION	RELAY MODE	RELAY SETPOINT	RELAY HYSTERESIS					
SETUP CONTROL INPUTS	SETUP CONTROL INPUTS 1, 2, 3	CONTROL INPUT 1 USAGE	CONTROL INPUT 2 USAGE	CONTROL INPUT 3 USAGE									
SETUP REAL TIME CLOCK	SETUP REAL TIME CLOCK	CLOCK TYPE	SELECT CLOCK AM/PM	TIME OF DAY	ENTER DATE								
SERIAL USAGE	SERIAL HARDWARE	DEVICE ID	BAUD RATE	PARITY	HANDSHAKE	DEVICE LINE FEED	MODEM OPTIONS	MODEM INIT ANSWER	CALL OUT DAY OF WEEK	CALL OUT TIME	CALL ON ERROR/ALARM	CALL OUT NO	NUMBER OF REDIALS
SETUP DATALOG/PRINT	SETUP DATALOG/PRINT	OUTPUT FORMAT	PAGE LENGTH	TOP MARGIN	DATALOG ONLY	PRINT TIME	PRINT INTERVAL	ENABLE PRINT KEY	CLEAR TOTAL IF PRINT	PRINT END OF BATCH	PRINT LIST ITEMS		HANGUP IF 2MIN. INACTIVE
ADMINISTRATIVE SETUP	TAG NUMBER	OPERATOR PASSWORD	SUPERVISOR PASSWORD	SOFTWARE VERSION	PRODUCT ORDER CODE	UNIT SERIAL NUMBER	SENSOR SERIAL NUMBER	DISPLAY NEW ERROR ONLY					
SETUP NETWORK CARD	SELECT NETWORK PROTOCOL	NETWORK DEVICE ID	BAUD RATE	PARITY									

These functions will only appear with appropriate settings in other functions.