

CO₂ Sensor USER'S MANUAL

Thank you very much for buying this GRAPHTEC product.

This product is a measurement sensor (hereafter "module") that connects to the GL100-N/GL100-WL.

These directions describe preparations and cautions before measurement.

To ensure safety, please read the operation instructions, etc.

For details on the warnings and how to handle this module, please read the Quick Start Guide or USER'S MANUAL included on the CD-ROM (included in the GL100 packaging)

Confirmation of the exterior

After opening the package, please confirm that there are no problems (scratches and dirt) on the exterior before use.

Confirmation of the attached items.

- User's manual (this book): 1

If by any chance faults are found, please contact the store where you bought the item.

* Please note that items mentioned in this book may change without prior notice.

604309071

MANUAL-CO

1 Part Names

This section describes the name and function of each part.

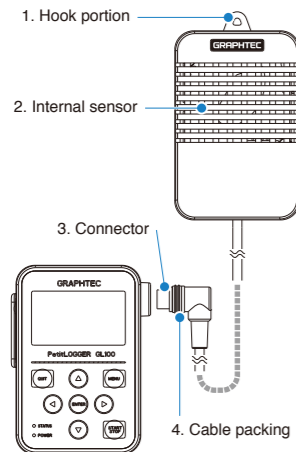

GL100 main module

1. Hook portion Used to mount to a wall.
2. Internal sensor There is an internal sensor that detects the CO₂. The lamp for detecting flashes every two seconds.
3. Connector Used to connect to the connector on the GL100 module.
4. Cable packing This packing is used when connecting the connector.

- CAUTION**
- The battery is not available for power supply. Use the USB cable to supply the power.
 - Do not use the module close to your face. Your breath may affect measurements.
 - Blocking the module's aperture may cause the airflow to affect measurements.

After connecting the GL100 to modules or sensors, please always check/set the time and date.

2 How To Measure

1. Power supply (Refer to Quick Start Guide or USER'S MANUAL.)

Supply power to this module via a USB cable connection.

WARNING This module cannot be powered with batteries. Connecting the sensor will bring up the display "Sensor error!!" Remove the sensor, supply power to the module via USB cable connection and then operate it using the procedures below.

2. Start-up and operation

(1) Screen display menu flow

After power-on, the GL100 is ready for operation by holding down [MENU] key. When the module is connected, "Module Type Recognition" screen is displayed. When the module is not connected, "Module Unconnected State" screen is displayed.

Operate in accordance with the displayed instructions.



Module unconnected state

<Operation>
Connect the module.



Recognition of module types

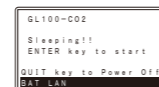

Standby state

<Operation>
Press [ENTER] key.



Module start-up

(2) Free-running screen



Hold down the [QUIT] key (approx. three seconds) to put the module into standby state. Press the [ENTER] key while in standby state to return to the free-running screen.

3. Setting

(1) Setting screen operation

Item selecting screen

Press the [MENU] key on the free-running screen to go to the setting screen.

<How to set>

Select the item with the directional keys (Δ▽◀▶) and press the [ENTER] key.

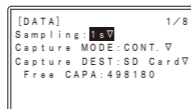

If the submenu shows ↑ ↓ then there are selections in those directions.

Numerical entry screen

<How to set>

Numbers can be inputted by increasing or decreasing the value with the Δ and ▽ keys.



(2) DATA setting

Set the Sampling and Capture Mode those will be recorded to the data recording media.

The recorded data's size will be displayed in the information for the SD card being recorded to. Please take note of it.

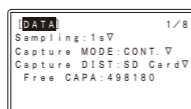

DATA recording condition setting

Sampling	500 ms, 1, 2, 5, 10, 20, 30 s, 1, 2, 5, 10, 20, 30, 60 min
Capture MODE	CONT, 1 Hour, 24 Hour
Capture DIST	Memory, SD card

(3) TRIGGER setting

Select the conditions for beginning data recording after measurement starts.

Off : Pressing the [START/STOP] key on this module will start/stop recording.

Start : The recording will start with the trigger source conditions after pressing the [START/STOP] key.

The recording will stop after pressing the [START/STOP] key.

Stop : The recording will start after pressing the [START/STOP] key and will be stopped with the trigger source conditions.

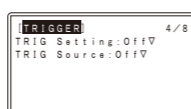

TRIGGER capture condition settings

TRIG setting	Off, Start, Stop
TRIG Source	Off, Alarm, Date
Date	Date, Time

(4) ALARM setting

The alarm information is required to set. Please set the number level when an alarm occurs.



ALARM settings		
Alarm	Off	Off
Level / Mode	Level	Level
	↑ H Value setting	
	↓ L The level depends on the setting range.	

3 Recording

(1) Recording

Press the [START/STOP] key to start measuring with the set conditions.

After pressing [START] key, when the module is in awaiting recording start, "ARMED" is displayed, and then when recording is started, "REC" is displayed. When alarm occurs, "ALM" is displayed.

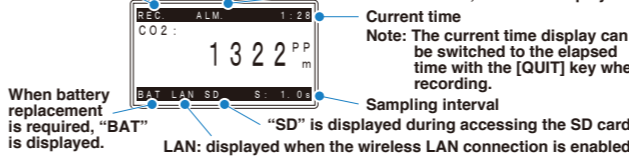

The module's status is shown with the lamp display.

STATUS (Orange)	
Accessing SD card	Access light
Low battery	Flash once every 5 seconds
Alarm active	Flash once every 10 seconds
POWER (Green)	
Processing	Flash once every 10 seconds
Wireless LAN connection possible status	Flash once every 5 seconds

CAUTION When accessing an SD card, do not remove the SD card. The data may not write properly or the SD card may be damaged.

(2) Recording completion

- Press the [START/STOP] key to stop measuring.
- The screen display will change to the standby screen display.
- Press [ENTER] key to change to the free-running screen display.

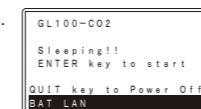

4 How To Confirm The Data

Check the recorded data with the application software included with this module using the method below (for details, refer to the USER'S MANUAL).

- (1) Connect the USB interface and check the online data
- (2) Insert the SD card into PC and check the data directly
- (3) Check the data directly from PC via wireless LAN

5 Specifications

Item	Contents
Sensor method	NDIR system
Measurement data	CO ₂ density
Measurement channel	1 channel
Measurement density range	0 to 9999 ppm
Measurement density accuracy	±(5% of rdg + 30 ppm) *Within the range of 0 to 5000 ppm
Responsive	3 minutes or less
Sampling interval	0.5, 1, 2, 5, 10, 20, 30 sec. 1, 2, 5, 10, 20, 30, 60 min. * The processing of sensor is every 2 sec. Even if setting it to 0.5 or 1 sec, the data is processed at the same value (2 sec).
Alarm	OFF / Level
Cable length	approximate 20 cm
Usage environment	0 to 50°C, 80% RH or less (non-condensing)
External dimensions [WxDxH] (approximate)	66 × 100 × 24.6 mm (not including protruding parts)
Weight (approximate)	99 g

* We recommend replacing the module periodically.

6 Combined Measurement

1. Combined CO₂ sensor and illumination / ultraviolet sensor measurement

Composite measurement can be done by using the branch adapter for GS (GS-DPA) and the illumination / ultraviolet sensor (GS-LXUV) (each sold separately).

WARNING If the CO₂ sensor (GS-CO2) is included in the assembly, it cannot be powered with batteries.

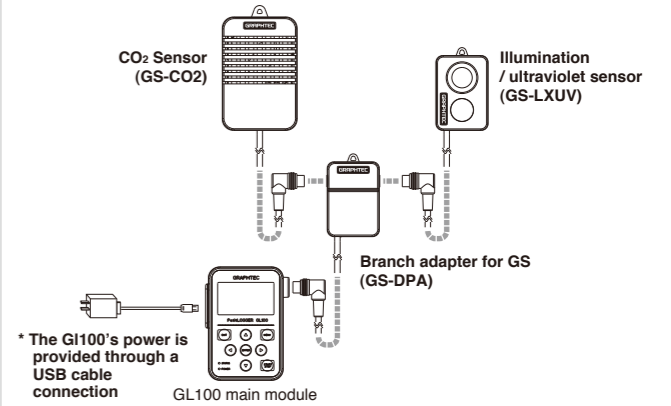

* The GL100's power is provided through a USB cable connection GL100 main module

(1) Screen display menu flow

After connecting the power supply, connect this module and operate it in accordance with the content displayed on the screen.

* Refer to "2 How To Measure" above and the USER'S MANUAL for the illumination / ultraviolet sensor.

(2) Free-running screen

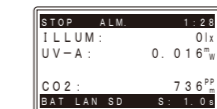

Hold down the [QUIT] key (approx. three seconds) to put the module into standby state. Press the [ENTER] key while in standby state to return to the free-running screen.

2. Combined CO₂ sensor and temperature and humidity sensor measurement

Composite measurement can be done by using the branch adapter for GS (GS-DPA) and the temperature and humidity sensor (GS-TH) (each sold separately).

WARNING If the CO₂ sensor (GS-CO2) is included in the assembly, it cannot be powered with batteries.

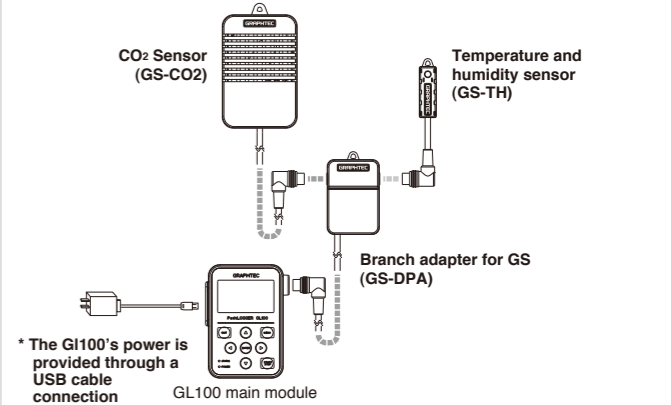

* The GL100's power is provided through a USB cable connection GL100 main module

(1) Screen display menu flow

After connecting the power supply, connect this module and operate it in accordance with the content displayed on the screen.

* Refer to "2 How To Measure" above and the USER'S MANUAL for the temperature and humidity sensor.

(2) Free-running screen

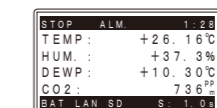

Hold down the [QUIT] key (approx. three seconds) to put the module into standby state. Press the [ENTER] key while in standby state to return to the free-running screen.

< Extension cable >
The module can be used approx. 1.5 m away from the GL100 by using an extension cable for GS (GS-EXC). However, you cannot connect and use multiple extension cables.

CAUTION
It is not possible to be used by connecting two same sensors.