

▪ CLAMP MULTIMETER

# METRACLIP 87









ENGLISH

User's manual

 GOSSEN METRAWATT

# CONTENTS

<b>1</b>	<b>PRESENTATION</b>	<b>8</b>
1.1	THE SWITCH	9
1.2	THE KEYS OF THE KEYPAD	10
1.3	THE DISPLAY UNIT	11
1.3.1	The symbols of the display unit	11
1.3.2	Measurement capacity exceeded (O.L)	13
1.4	THE TERMINALS	13
<b>2</b>	<b>THE KEYS</b>	<b>14</b>
2.1	KEY	14
2.2	KEY (SECOND FUNCTION)	15
2.3	KEY	15
2.4	KEY	16
2.5	KEY	17
2.5.1	In the normal mode	17
2.5.2	Access to the True-INRUSH mode (  set to  )	18
2.5.3	The MAX/MIN/PEAK mode + activation of the HOLD mode	18
2.6	KEY	19
2.6.1	The Hz function in the normal mode	19
2.6.2	In the display of orders of harmonics mode  or  + 	20
2.6.3	In Hz mode + activation of the HOLD mode	20
<b>3</b>	<b>USE</b>	<b>21</b>
3.1	COMMISSIONING	21
3.2	STARTING UP THE CLAMP MULTIMETER	21
3.3	SWITCHING THE CLAMP MULTIMETER	22
3.4	CONFIGURATION	22
3.4.1	De-activation of automatic switching off (Auto Power OFF)	22
3.4.2	Programming of the current threshold for the True INRUSH measurement	22
3.4.3	Programming the rate of recording in memory	23
3.4.4	Erasure of the records in memory	23
3.4.5	Default configuration	23
3.5	VOLTAGE MEASUREMENT (V)	24
3.6	CONTINUITY TEST 	25
3.7	RESISTANCE MEASUREMENT $\Omega$	26
3.8	CURRENT MEASUREMENT (A)	26
3.8.1	AC measurement	26
3.8.2	DC or AC+DC measurement	27
3.9	STARTING CURRENT OR OVERCURRENT (TRUE INRUSH) MEASUREMENT	29
3.10	POWER MEASUREMENTS W, VA, VAR, PF AND DPF	30

3.10.1	Measurement of single-phase power .....	31
3.10.2	Balanced three-phase power measurement.....	32
3.10.3	Four quadrant diagram .....	33
3.11	ENERGY METERING MEASUREMENT.....	33
3.12	FREQUENCY MEASUREMENT (Hz).....	37
3.12.1	Frequency measurement in voltage.....	37
3.12.2	Frequency measurement in current.....	38
3.13	MEASUREMENT OF THE TOTAL HARMONIC DISTORTION (THD) AND DISPLAY OF THE ORDERS OF HARMONICS.....	38
3.13.1	Measurement of the THD in voltage .....	38
3.13.2	Measurement of the THD in current .....	39
3.13.3	Display of the 25 orders of harmonics and of the frequency of the fundamental .....	40
3.14	RECORDING OF MEASUREMENT DATA/CAMPAIGNS .....	41
3.15	PROCESSING OF THE DATA ON A PC WITH THE PAT SOFTWARE .....	41
<b>4</b>	<b>CHARACTERISTICS .....</b>	<b>FEHLER! TEXTMARKE NICHT DEFINIERT.</b>
4.1	REFERENCE CONDITIONS .....	55
4.2	CHARACTERISTICS UNDER THE REFERENCE CONDITIONS .....	55
4.2.1	DC voltage measurement.....	56
4.2.2	AC voltage measurement .....	56
4.2.3	AC+DC voltage measurement.....	57
4.2.4	DC current measurement.....	57
4.2.5	AC current measurement .....	58
4.2.6	AC+DC intensity measurement .....	58
4.2.7	True-Inrush measurement.....	59
4.2.8	Calculation of the crest factor (CF).....	59
4.2.9	Calculation of the RIPPLE in DC .....	60
4.2.10	Continuity measurement .....	60
4.2.11	Resistance measurement.....	60
4.2.12	Active DC power measurements.....	61
4.2.13	Active AC power measurements .....	61
4.2.14	Active AC+DC power measurements.....	62
4.2.15	Measurement of apparent AC power.....	63
4.2.16	Measurement of apparent AC+DC power .....	63
4.2.17	Measurement of reactive AC power .....	64
4.2.18	Measurement of reactive AC+DC power.....	65
4.2.19	Calculation of the power factor (PF).....	65
4.2.20	Calculation of the displacement power factor (DPF).....	66
4.2.21	Frequency measurements.....	66
4.2.22	Characteristics in THDr .....	67
4.2.23	Characteristics in THDf.....	67
4.2.24	Harmonic measurement characteristics.....	67
4.3	ENVIRONMENTAL CONDITIONS .....	68
4.4	CHARACTERISTICS OF CONSTRUCTION .....	68
4.5	POWER SUPPLY .....	69











4.6	COMPLIANCE WITH INTERNATIONAL STANDARDS .....	69
4.7	VARIATIONS IN THE DOMAIN OF USE .....	69
<b>5</b>	<b>MAINTENANCE .....</b>	<b>71</b>
5.1	CLEANING .....	71
5.2	REPLACEMENT OF THE BATTERIES .....	71
5.3	METROLOGICAL CHECK .....	71
5.4	REPAIR .....	71
<b>6</b>	<b>WARRANTY .....</b>	<b>72</b>
<b>7</b>	<b>DELIVERY CONDITION .....</b>	<b>72</b>
<b>8</b>	<b>ADDRESSES.....</b>	<b>73</b>

You have just acquired an **METRACLIP 87 clamp multimeter** and we thank you.

For best results from your device :

- **read** this user manual attentively,
- **observe** the precautions for its use.

### Meanings of the symbols used on the device

-  Danger. The operator agrees to refer to this data sheet whenever this danger symbol is encountered.
-  Application or withdrawal authorized on uninsulated or bare conductors at dangerous voltages.
-  1.5 V battery.
-  The CE marking indicates compliance with European directives.
-  Double insulation or reinforced insulation.
-  Selective sorting of wastes for the recycling of electrical and electronic equipment within the European Union.
-  In conformity with directive DEEE 2002/96/EC: this equipment must not be treated as household waste.
-  AC – Alternating current.
-  AC and DC – Alternating and direct current.
-  Earth.
-  Risk of electric shock.

## PRECAUTIONS FOR USE

---

This device complies with safety standards IEC-61010-1 and 61010-2-032 for voltages of 1000V in category IV at an altitude OF less than 2000m, indoors, with a degree of pollution not exceeding 2.

These safety instructions are intended to ensure the safety of persons and proper operation of the device. If the tester is used other than as specified in this data sheet, the protection provided by the device may be impaired.

- The operator and/or the responsible authority must carefully read and clearly understand the various precautions to be taken in use.
- If you use this instrument other than as specified, the protection it provides may be compromised, thereby endangering you.
- Do not use the instrument in an explosive atmosphere or in the presence of flammable gases or fumes.
- Do not use the instrument on networks of which the voltage or category exceeds those mentioned.
- Do not exceed the rated maximum voltages and currents between terminals or with respect to earth.
- Do not use the instrument if it appears to be damaged, incomplete, or not properly closed.
- Before each use, check the condition of the insulation on the leads, housing, and accessories. Any element of which the insulation is deteriorated (even partially) must be set aside for repair or scrapped.
- Use leads and accessories rated for voltages and categories at least equal to those of the instrument. If not, an accessory of a lower category lowers the category of the combined Clamp + accessory to that of the accessory.
- Observe the environmental conditions of use.
- Do not modify the instrument and do not replace components with "equivalents". Repairs and adjustments must be done by approved qualified personnel.
- Replace the batteries as soon as the  symbol appears on the display unit. Disconnect all cords before opening the battery compartment cover.
- Use personal protective equipment when conditions require.
- Keep your hands away from the unused terminals of the instrument.

- When handling the test probes, crocodile clips, and clamp ammeters, keep your fingers behind the physical guard.
- As a safety measure, and to avoid repeated overloads on the inputs of the device, we recommend performing configuration operations only when the device is disconnected from all dangerous voltages.

## MEASUREMENT CATEGORIES

---

### Definitions of the measurement categories :

**CAT II:** Circuits directly connected to the low-voltage installation.

*Example: power supply to household electrical appliances and portable tools.*

**CAT III:** Power supply circuits in the installation of the building.

*Example: distribution panel, circuit-breakers, fixed industrial machines or devices.*

**CAT IV:** Circuits supplying the low-voltage installation of the building.

*Example: power lines, meters, and protection devices.*

# 1 PRESENTATION

The **METRACLIP 87** is a professional electrical measuring instrument that combines the following functions:

- Current measurement;
- Measurement of inrush current / overcurrent (True-Inrush);
- Voltage measurement;
- Frequency measurement;
- Measurement of harmonic distortion, total (THD) and order by order;
- Continuity test with buzzer;
- Resistance measurement;
- Power (W, VA, var and PF) and Energy measurements;
- Measurement of the Crest Factor (CF), the Displacement Power Factor (DPF), and RIPPLE;
- Recording of data in memory, Wireless data transfer to a PC (by Bluetooth);



Item	Designation	See §
1	Jaws with centring marks (see connection principles)	<a href="#">3.5</a> to <a href="#">3.13</a>
2	Physical guard	-
3	Switch	<a href="#">1.1</a>
4	Function keys	<a href="#">2</a>
5	Display unit	<a href="#">1.3</a>
6	Terminals	<a href="#">1.4</a>
7	Trigger	-

Figure 1 : the METRACLIP 87 clamp multimeter



## 1.1 THE SWITCH

The switch has five positions. To access the  $V_{\sim}$ ,  $\Omega$ ,  $A_{\sim}$ ,  $W_{\sim}$ , functions, set the switch to the desired function. Each setting is confirmed by an audible signal. The functions are described in the table below.

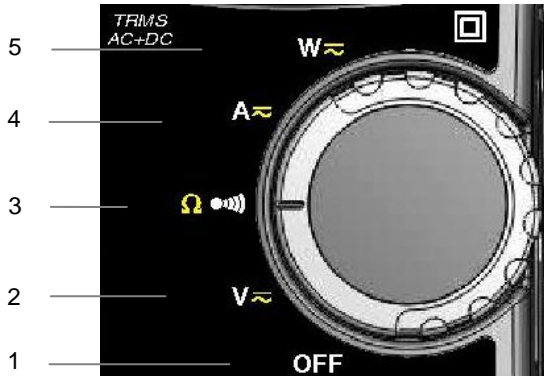

**Figure 2 : the switch**

Item	Function	See §
1	OFF mode – Switches the clamp multimeter off	<a href="#">3.3</a>
2	AC, DC, AC+DC voltage measurement (V)	<a href="#">3.5</a>
3	Continuity test $\bullet$ ))) Resistance measurement $\Omega$	<a href="#">3.6</a> <a href="#">3.7</a>
4	AC, DC, AC+DC current measurement (A)	<a href="#">3.8</a>
5	Power measurements (W, var, VA) AC, DC, AC+ DC Calculation of the power factor (PF), of the displacement power factor (DPF), of the Energy	<a href="#">3.10</a>

## 1.2 THE KEYS OF THE KEYPAD

Here are the six keys of the keypad :

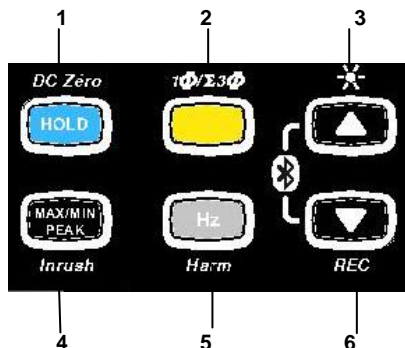

Figure 3 : the keys of the keypad

Item	Function	See §
1	Storage of values, disabling of display Zero correction $A_{DC}/A_{AC+DC}/W_{DC}/W_{AC+DC}$	<a href="#">2.1</a> <a href="#">3.8.2</a>
2	Selection of the type of measurement (AC, DC) Selection of single-phase or three-phase measurement	<a href="#">2.2</a>
3	Activation or de-activation of the backlighting of the display unit Scrolling up of orders of harmonics or of pages of results in W, MAX/MIN/PEAK Activation or de-activation of BT wireless transfer (in combination with 6)	<a href="#">2.3</a>
4	Activation or de-activation of the MAX/MIN mode Activation or de-activation of the INRUSH mode in A	<a href="#">2.5</a>
5	Measurements of frequency (Hz), of total harmonic distortion (THD), and of orders of harmonics Activation or de-activation of the energy metering mode	<a href="#">2.6</a>
6	Scrolling down of orders of harmonics or of pages of results in W, MAX/MIN/PEAK Activation or de-activation of recording of current data in memory Activation or de-activation of BT wireless transfer (in combination with 3)	<a href="#">2.4</a>

### 1.3 THE DISPLAY UNIT

Here is the display unit of the clamp multimeter:

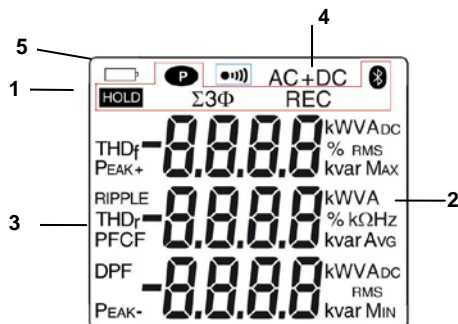





Figure 4 : the display unit

Item	Function	See §
1	Display of the modes selected (keys)	<a href="#">2</a>
2	Display of the measurement value and unit	<a href="#">3.5 to 3.13</a>
3	Display of the MAX/MIN modes	<a href="#">3.10</a>
4	Type of measurement (AC or DC)	<a href="#">2.2</a>
6	Spent battery indication	<a href="#">5.2</a>

#### 1.3.1 The symbols of the display unit

Symbol	Designation
AC	Alternating current or voltage
DC	Direct voltage
AC+DC	Alternating and direct current
<b>HOLD</b>	Storage of the values and hold of the display
RMS	RMS value
Max	Maximum RMS value

<b>Min</b>	Minimum RMS value
<b>AVG</b>	Mean RMS value
<b>PEAK+</b>	Maximum peak value
<b>PEAK-</b>	Minimum peak value
<b><math>\Sigma 3\Phi</math></b>	Balanced total three-phase power measurement
<b>V</b>	Volt
<b>Hz</b>	Hertz
<b>W</b>	Active power
<b>A</b>	Ampere
<b>%</b>	Percentage
<b><math>\Omega</math></b>	Ohm
<b>m</b>	Milli- prefix
<b>k</b>	Kilo- prefix
<b>var</b>	Reactive power
<b>VA</b>	Apparent power
<b>PF</b>	Power factor
<b>DPF</b>	Displacelent power factor ( $\cos \varphi$ )
<b>CF</b>	Crest factor
<b>RIPPLE</b>	Ripple (in DC)
<b>THDf</b>	Total harmonic distorsion with respect to the fundamental
<b>THDr</b>	Total harmonic distorsion with respect to the true RMS value of the signal
<b>REC</b>	Recording in memory

	BlueTooth wireless communication
	Continuity test
	Permanent display (automatic switching off de-activated)
	Spent battery indicator

### 1.3.2 Measurement capacity exceeded (O.L)

The O.L (Over Load) symbol is displayed when the display capacity is exceeded.

## 1.4 THE TERMINALS

The terminals are used as follows:

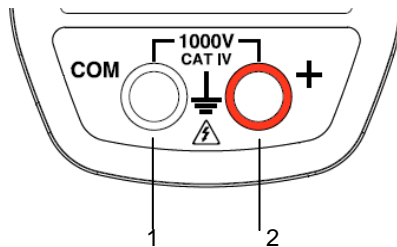

**Figure 5 : the terminals**

Item	Function
1	Cold terminal ( <b>COM</b> )
2	Hot terminal ( <b>+</b> )







## 2 THE KEYS

The keys of the keypad respond differently to short, long, and sustained presses. In this section, the  icon represents the possible positions of the switch for which the key concerned has some action.

### 2.1 KEY

This key is used to:

- store and look up the last values acquired specific to each function (V, A,  $\Omega$ , W) according to the specific modes previously activated (MAX/MIN/PEAK, Hz, THD); the present display is then maintained while the detection and acquisition of new values continues;
- perform an automatic zero correction in  $A_{DC/AC+DC}$  et  $W_{DC/AC+DC}$  (see also § [3.9.2](#))









Successive presses on 		... serve
short	   	<ol style="list-style-type: none"> <li>1. to store the results of the present measurements</li> <li>2. to hold the display of the last value displayed</li> <li>3. to return to normal display mode (the value of each new measurement is displayed)</li> </ol>
Long (> 2 sec)	ADC A AC+DC WDC W AC+DC	To perform automatic compensation of the zero  <i>Remark</i> : this mode operates if the MAX/MIN/PEAK or HOLD modes (short press) are first deactivated.

See also § [2.5.3](#) and § [2.6.3](#) for the action  key with the action of the  key and with the action of the  key.

## 2.2 KEY (SECOND FUNCTION)

This key is used to select the type of measurement (AC, DC, AC+DC) and the second functions marked in yellow next to the relevant positions of the switch. It can also be used in the configuration mode, to modify the default values (see §3.4)









**Remark:** the key is invalid in the MAX/MIN/PEAK and HOLD modes.







Successive presses on 		... serve
short	  	-to select AC, DC or AC+DC. Depending on your choice, the screen displays AC, DC or AC+DC
		-to cycle through the $\Omega$ mode or the continuity test 
Long (> 2 sec)		- to display the total three-phase power of a balanced system ( $\Sigma 3\Phi$ is displayed). - by pressing again, to return to display of the single-phase power ( $\Sigma 3\Phi$ is off)

## 2.3 KEY

This key is used to :

- Scroll orders of harmonics or successive pages up;
- Activate the back-lighting;
- Activate the Bluetooth function.















Successive presses on 		... serve
short	  	to scroll through the various pages of measurement results, depending on the function and possibly the active mode (MAX/MIN/PEAK or THD/Harmonics)
long (> 2 sec)	   	to activate/de-activate the back-lighting of the display unit.  <i>Remark: the back-lighting is switched off automatically at the end of 2 minutes.</i>

Combined with the  key	   	To activate Bluetooth wireless communication.  The  symbol is the displayed.  <i>Remark: activation of the Bluetooth mode automatically stops the recording of the data.</i>
---	--	---

## 2.4 KEY

This key is used to :

- Scroll down through the orders of harmonics or successive pages;
- Activate the recording of the data;
- Activate the Bluetooth function.

<b>Successive presses on </b>		<b>... serve</b>
short	  	to scroll through the various pages of measurement results, depending on the function and possibly the active mode (MAX/MIN/PEAK or THD/Harmonics)
long (> 2 sec)	   	activate/de-activate the recording of the data.  The <b>REC</b> symbol is then displayed.  <i>Remark: when the recording memory is full, the REC symbol flashes</i>
combiné avec la touche 	   	To activate Bluetooth wireless communication.  The  symbol is then displayed.  <i>Remark: activation of the Bluetooth mode automatically stops the recording of the data.</i>



## 2.5 KEY











### 2.5.1 In the normal mode

This key activates detection of the MAX, MIN, PEAK+, PEAK- or AVG values of the measurements made.

Max and Min are the extreme mean values in DC and the extreme RMS values in AC. Peak+ is the maximum instantaneous peak and Peak- is the minimum instantaneous peak.





AVG is the moving average of 4 measurements.

**Remark :** in this mode, the "automatic switching off" function of the device is automatically de-activated. The  symbol is displayed on the screen.







Successive presses on 		... serve
short	 	- to activate detection of the MAX/MIN/PEAK values - to display the MAX, AVG, MIN and PEAK+, AVG, PEAK- values (on a second screen)  - to return to display of the present measurement without exiting from the mode (the values already detected are not erased)  <i>Remark:</i> depending on the mode, AC or DC, the crest factor (CF), harmonics, frequency, and RIPPLE are also available.
	 	- to activate detection of the MAX/MIN/AVG values. - to display the MAX, MIN, and AVG simultaneously.  - to return to display of the present measurement without exiting from the mode (the values already detected are not erased)
long (> 2 sec)	   	to exit from the MAX/MIN/PEAK mode. The values previously recorded are then erased.  <i>Remark:</i> if the HOLD function is activated, it is not possible to exit from the MAX/MIN/PEAK mode. The HOLD function must first be de-activated.

## 2.5.2 Access to the True-INRUSH mode (MAX/MIN/PEAK set to A $\tilde{\sim}$ )

This key allows measurement of the True-Inrush current (starting current, or overcurrent in steady-state operation) for AC or DC current only (not operational in AC+DC).

Successive presses on 		...serves
long (>2 sec)		<p><b>to enter</b> the True-INRUSH mode</p> <ul style="list-style-type: none"> <li>- "Inrh" is displayed for 3s (the backlighting blinks)</li> <li>- the triggering threshold is displayed for 5s (the backlighting is steady);</li> <li>- "-----" is displayed and the "A" symbol flashes</li> <li>- after detection and acquisition, the inrush current measurement is displayed, after the calculations stage "-----" (backlighting off)</li> </ul> <p><i>Remark:</i> the A symbol flashes to indicate "surveillance" of the signal.</p> <p><b>to exit</b> from the True-INRUSH mode (return to simple current measurement).</p>
short (<2 sec)  <i>Note:</i> a short press is functional only if an True-Inrush value has been detected.		<ul style="list-style-type: none"> <li>- to display the PEAK+ value of the current</li> <li>- to display the PEAK- value of the current</li> <li>- to display the RMS True-Inrush current</li> </ul> <p><i>Remark:</i> the A symbol is displayed steadily during this sequence.</p>

## 2.5.3 The MAX/MIN/PEAK mode + activation of the HOLD mode

Successive presses on 		... serve
short	   	<p>to display successively the MAX, AVG, MIN and PEAK+, AVG, PEAK-</p> <p>The values displayed are the same before the <b>HOLD</b> key was pressed.</p>











Note: the HOLD function does not interrupt the acquisition of new MAX, MIN, PEAK values

## 2.6 KEY







This key is used to display measurements of the frequency of a signal, of power, of the levels and orders of harmonics.

**Remark** : this key is not working in DC mode.





### 2.6.1 The Hz function in the normal mode

Successive presses on 		...serves
short	 	to display: <ol style="list-style-type: none"> <li>1.the frequency of the signal, the RMS measurement, and the DC component</li> <li>2.the crest factor CF, the RMS measurement, and the DC component</li> </ol>
Long (> 2 sec)	 	<ol style="list-style-type: none"> <li>1. to enter or exit from the THD calculation and display mode</li> <li>2. to display the THDf, the THDr, and the RMS value.</li> <li>3. The  and  keys are used to display each order of harmonic (25 orders, from h01 to h25), with the associated harmonic distortion (with respect to the fundamental) and the RMS value of order hxx.  <b>Note:</b> order hdC (displayed in the DC and AC+DC modes) is the DC component; order h01 is the fundamental.</li> </ol>
		<ol style="list-style-type: none"> <li>1. to activate or stop the energy metering mode</li> <li>2.to display the various energy parameters</li> <li>3.The  and  keys are used to display the status and energy metering measurement results pages.</li> </ol>

### 2.6.2 In the display of orders of harmonics mode or +

Successive presses on 		...serve
short	 	to display the frequency of the order of harmonic previously selected using the  or  keys, instead of order hxx.  A 2nd short press restores display of order (hxx) or hdC

### 2.6.3 In Hz mode + activation of the HOLD mode

Successive presses on 		...serve
short	 	To store and display the frequency with the RMS value and the DC component, then, on a 2nd consecutive page, the crest factor CF.  Note: the values displayed are those measured before the HOLD key is pressed

## 3 USE

### 3.1 COMMISSIONING

Insert the batteries supplied with the device as follows:

1. Using a screwdriver, unscrew the screw of the battery compartment cover (item 1) on the back of the housing and open it.
2. Place the 4 batteries in the compartment (item 2), taking care to get the polarities right.
3. Close the battery compartment cover and screw it to the housing.

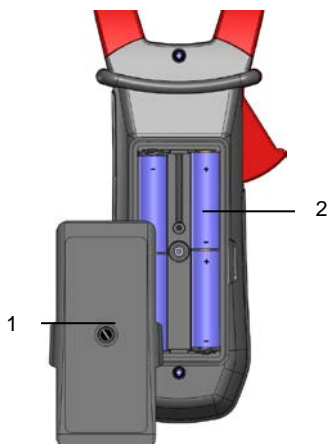

Figure 6 : the battery compartment cover

### 3.2 STARTING UP THE CLAMP MULTIMETER

The switch is set to OFF. Turn the switch to the function of your choice. The whole display lights (all symbols) for a few seconds (see §1.3), then the screen of the function chosen is displayed. The clamp multimeter is then ready to make measurements.

### 3.3 SWITCHING THE CLAMP MULTIMETER

The clamp multimeter can be switched off either manually, by setting the switch to OFF, or automatically, after ten minutes with no action on the switch and/or the keys. Thirty (30) seconds before the device is switched off, an audible signal sounds intermittently. To re-activate the device, press any key or turn the switch.

### 3.4 CONFIGURATION

As a safety measure, and to avoid repeated overloads on the inputs of the device, we recommend performing configuration operations only when the device is disconnected from all dangerous voltages.

#### 3.4.1 De-activation of automatic switching off (Auto Power OFF)

To de-activate automatic switching off:

In the OFF position, hold the **HOLD** key down while turning the switch to **V<sub>AC</sub>**, until the "full screen" display ends and a beep is emitted, to enter the configuration mode. The **P** symbol is displayed.

When the **HOLD** key is released, the device is in the voltmeter function in the normal mode.

The return to Auto Power OFF takes place when the clamp is switched back on.

#### 3.4.2 Programming of the current threshold for the True INRUSH measurement

To program the triggering current threshold of the True INRUSH measurement:

1. in the OFF position, hold the **MAX/MIN PEAK** key down while turning the switch to **A<sub>AC</sub>**, until the "full screen" display ends and a beep is emitted, to enter the configuration mode. The display unit indicates the percentage overshoot to apply to the measured current to determine the measurement triggering threshold.



**Remark :** The value stored by default is 10%, representing 110% of the established current measured. The possible values are 5%, 10%, 20%, 50%, 70%, 100%, 150%, and 200%.

2. To change the threshold, press the **▲** key. The value flashes: each press on the **▲** key displays the next value. To record the chosen threshold, apply a long press (>2s) on the **▲** key. A confirmation beep is emitted.



To exit from the programming mode, turn the switch to another setting. The chosen threshold is stored (emission of a double beep).

Note: The starting current measurement triggering threshold is fixed at 1% of the least sensitive range. This threshold is not adjustable

### 3.4.3 Programming the rate of recording in memory

1. In the OFF position, hold the  key down while turning the switch to , until the end of the "full screen" display and the emission of a beep, to enter the configuration mode. The display unit then indicates the interval of recording of the data in memory.

**Remark:** the default value is 60 seconds. Possible values range from 1 second to 600 seconds (10 minutes).

2. To change the recording interval, press the  key. The right-hand digit blinks: each press on the  key increments its value. To go to the next digit, apply a long press (>2s) to the  key.

When the desired unit is displayed, turn the switch to another setting. The unit chosen is stored (emission of a double beep).

### 3.4.4 Erasure of the records in memory



In the OFF position, hold the  key down while turning the switch to .

The device emits a beep after erasing the records in memory. The "rSt" and "rEC" symbols are displayed. The device then switches to normal continuity measurement.

We recommend not having any voltage on the input terminals while doing this.

### 3.4.5 Default configuration

To reset the clamp to its default parameters (factory configuration):

In the OFF position, hold the  key down while turning the switch to , until the "full screen" display ends and a beep is emitted, to enter the configuration mode. The "rSt" symbol is displayed.

After 2 s, the clamp emits a double beep, then all of the symbols of the screen are displayed until the  key is released. The default parameters are then restored:

Recording interval =60 seconds

True Inrush triggering threshold =10%

### 3.5 VOLTAGE MEASUREMENT (V)

To measure a voltage, proceed as follows :

1. Set the switch to **V $\overline{\sim}$**  ;
2. Connect the black lead to the COM terminal and the red lead to "+".
3. Place the test probes or the crocodile clips on the terminals of the circuit to be measured. The device selects AC or DC automatically according to which measured value is larger. The AC or DC symbol lights in blinking mode.

To select AC, DC or AC+DC manually, press the yellow key to reach the desired choice. The symbol corresponding to the choice made then lights in fixed mode.

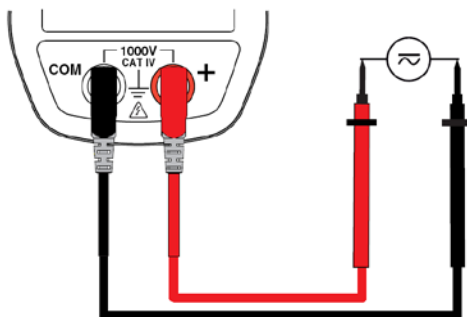

The measured values are displayed. :

- in DC

Display	Quantity
1 <sup>st</sup> row	Voltage V RMS
2 <sup>nd</sup> row	DC RIPPLE in %
3 <sup>rd</sup> row	DC voltage component, V DC

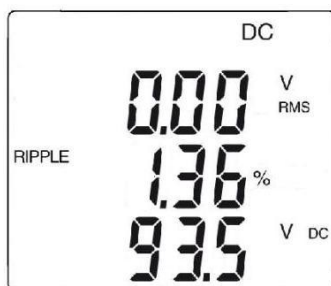





- in AC and AC+DC

Display	Quantity
1 <sup>st</sup> row	Total RMS voltage V RMS or TRMS
2 <sup>nd</sup> row	Crest factor (CF)
3 <sup>rd</sup> row	DC voltage component, V DC



### 3.6 CONTINUITY TEST

**Warning :** Before performing the test, make sure that the circuit is off and any capacitors have been discharged.

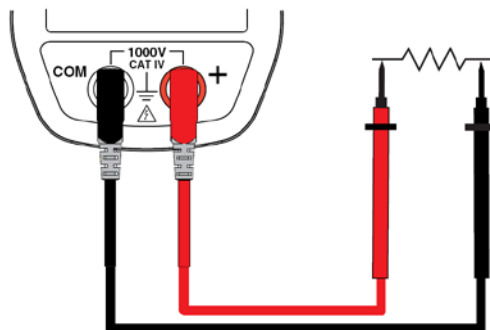

1. Set the switch to  ; the  symbol is displayed ;
2. Connect the black lead to the **COM** terminal and the red lead to «+».
3. Place the test probes or the crocodile clips on the terminals of the circuit or component to be tested.



An audible signal is emitted if there is continuity, and the measured value is displayed on the screen.

### 3.7 RESISTANCE MEASUREMENT $\Omega$

**Warning :** Before making a resistance measurement, make sure that the circuit is cold and any capacitors have been discharged.

1. Set the switch to  and press the  key. The  $\Omega$  symbol is displayed;
2. Connect the black lead to the **COM** terminal and the red lead to **« + »**;
3. Place the test probes or the crocodile clips on the terminals of the circuit or component to be measured ;

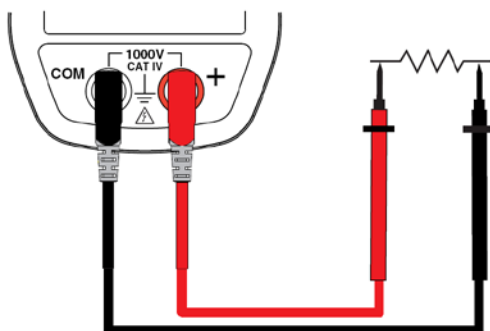

The measured value is displayed on the screen

### 3.8 CURRENT MEASUREMENT (A)



The jaws are opened by pressing the trigger on the body of the device. The arrow on the jaws of the clamp (see the diagram below) must point in the presumed direction of flow of the current, from the generator to the load. Make sure that the jaws have closed correctly.

**Remark:** the measurement results are optimal when the conductor is centred in the jaws (aligned with the centring marks).

The device automatically selects AC or DC according to which measured value is larger. The AC or DC symbol blinks.

#### 3.8.1 AC measurement

For an AC current measurement, proceed as follows:

1. Set the switch to  and select AC by pressing the  key. The AC symbol is displayed.
2. Encircle only the conductor concerned with the clamp ;

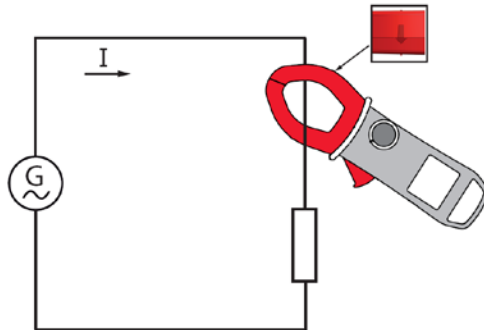

The measured values are displayed on the screen.

Display	Quantity
1 <sup>st</sup> row	RMS current A RMS
2 <sup>nd</sup> row	Crest factor (CF)
3 <sup>rd</sup> row	DC current component A DC



### 3.8.2 DC or AC+DC measurement

To measure the DC or AC+DC current, if the display unit does not indicate "0", first correct the DC zero as follows:



#### Step 1 : to correct the DC zero

**Important :** The clamp must not be closed on the conductor during the DC zero correction. Hold the clamp in the same position during the whole procedure so that the correction value will be exact.

Press the **HOLD** key until the device emits a double beep and displays a value near "0". The correction value is stored until the clamp is powered down.

**Remark** : the correction is effected only if the value displayed is  $< \pm 10$  A, otherwise the value displayed blinks and is not stored. The clamp must be recalibrated (see § 5.3)

### Step 2 : to make a measurement

1. The switch is set to **A** . Select DC or AC+DC by pressing the yellow  key until the desired choice is reached.
2. Apply the clamp to only the conductor concerned.

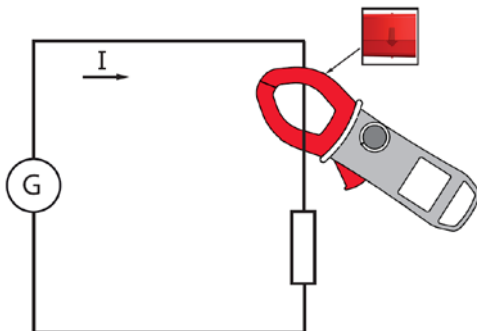

The measurement values are displayed :  
- in DC :

Display	Quantity
1 <sup>st</sup> row	Current A RMS
2 <sup>nd</sup> row	DC RIPPLE in %
3 <sup>rd</sup> row	DC current component A DC

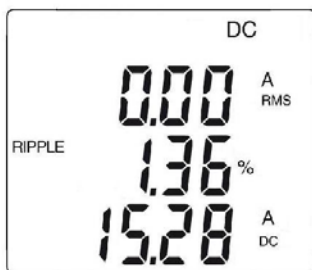

- in AC and AC+DC :

Display	Quantity
1 <sup>st</sup> row	Total RMS current in A RMS or TRMS
2 <sup>nd</sup> row	Crest factor (CF)
3 <sup>rd</sup> row	DC current component A DC

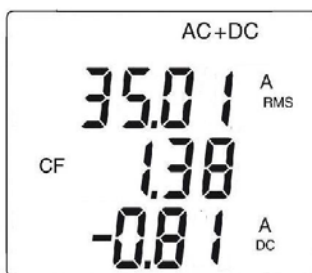

### 3.9 STARTING CURRENT OR OVERCURRENT (TRUE INRUSH) MEASUREMENT

To measure a starting current or overcurrent, proceed as follows:

1. Set the switch to **A**  then encircle only the conductor concerned with the clamp.
2. Effect a long press on the **MAX/MIN PEAK** key. The InRh symbol is displayed, then the triggering threshold. The clamp then awaits detection of the True-Inrush current. "-----" is displayed and the "A" symbol flashes (central row of the display).
3. After detection and acquisition for 100 ms, the RMS value of the True-Inrush current is displayed, along with the PEAK+/PEAK- values subsequently.
4. A long press on the **MAX/MIN PEAK** key or a change of function leads to exiting from the True-Inrush mode.

**Remark :** the triggering threshold in A is 10A if the initial current is zero (starting of installation); it is that set in the configuration (see §3.4.2) for an established current (overload in a installation)..

Display	Quantity
1 <sup>st</sup> row	"Inrh"
2 <sup>nd</sup> row	True Inrush value in A
3 <sup>rd</sup> row	Triggering threshold in A

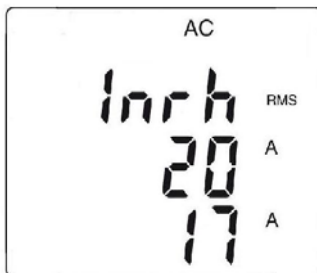

- PEAK display :

Display	Quantity
1 <sup>st</sup> row	"Inrh"
2 <sup>nd</sup> row	PEAK+ or PEAK- value in A
3 <sup>rd</sup> row	Triggering threshold in A

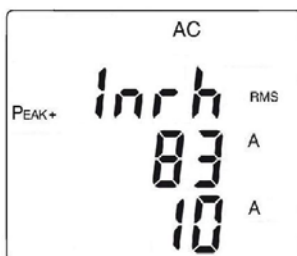

### 3.10 POWER MEASUREMENTS W, VA, VAR, PF AND DPF

This measurement is possible in single-phase or in balanced three-phase.

**Reminder :** in DC or AC+DC power measurement, first correct the DC zero in current (see § 3.8.2, step 1)

For the power factor (PF), the displacement power factor (DPF) and the powers VA and var measurement is possible only in AC or AC+DC.

### 3.10.1 Measurement of single-phase power

1. Set the switch to **W<sub>AC</sub>**;
2. The device automatically displays AC+DC. To select AC, DC, or AC+DC, press the **MODE** key until the desired choice is reached.
3. Connect the black lead to the **COM** terminal and the red lead to "+";
4. Place the test probes or the crocodile clips of the black lead on the neutral (N), then those of the red lead on the L phase.
5. Clamp only the corresponding conductor, respecting the direction;

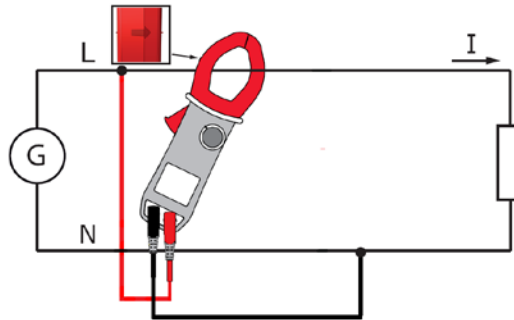

The measurement value are displayed :

Display	Quantity
1 <sup>st</sup> row	Active power W (DC, AC or AC+DC)
2 <sup>nd</sup> row	Reactive power var (AC or AC+DC)
3 <sup>rd</sup> row	Apparent power VA (AC or AC+DC)

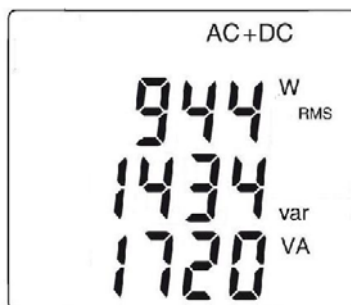

### 3.10.2 Balanced three-phase power measurement

1. Set the switch to **W<sub>RMS</sub>**;
2. Press the yellow **Σ3Φ** key until the **Σ3Φ** symbol is displayed.
3. The device automatically displays AC+DC. To select AC, DC, or AC+DC, press the yellow **+** key until the desired choice is reached.
4. Connect the black lead to the **COM** terminal and the red lead to "+";
5. Connect the leads and the clamp to the circuit as follows:

If the red lead is connected...	...and the black lead is connected	...then the clamp is on the conductor
To the L1 phase	to the L2 phase	of the L3 phase
To the L2 phase	to the L3 phase	of the L1 phase
To the L3 phase	to the L1 phase	of the L2 phase

**Reminder** : the arrow on the jaws of the clamp (see the diagram below) must point in the presumed direction of flow of the current from the source (producer) to the load (consumer)

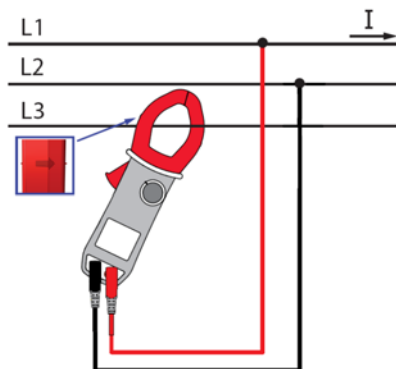

The measurement is displayed on screen.





**Remark :** You can also measure the three-phase power on a balanced 4-wire network by proceeding in the same way, or by proceeding as for the measurement on a single-phase network, then multiplying the value found by three.

### 3.10.3 Four quadrant diagram

In order to determine correctly the signs of the active and reactive powers, we refer to the diagram below, which determines :

- positive active power (W) = power consumed
- negative active power = power generated
- reactive power (var) and active power of the same sign = inductive power
- reactive power and active power of opposite signs = capacitive power

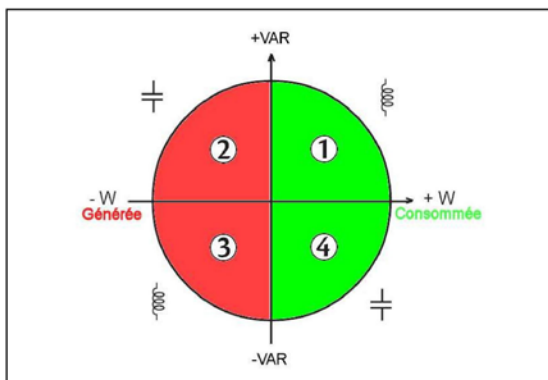

## 3.11 ENERGY METERING MEASUREMENT

The Energy Metering measurement is available in W for the AC and AC+DC quantities.

The energy meters start and totalize the various types of energy (the eight energy meters - 4 meters of energy consumed and 4 meters of energy generated - are started).

To measure the energy metering, proceed as follows:

1. Set the switch to **W** ;
2. Press the **Hz** (long press). Start-up screen 1 in the Energy Metering mode appears ;



3. Connecting the black lead to the **COM** terminal and the red lead to « + » ;
4. Place the test probes or the crocodile clips of the black lead on the neutral (N), then those of the red lead on the L phase;
5. Place the clamp around the single conductor concerned, respecting the direction (see §3.10);
6. To access the metering, press the  key :

The sequence of use is as follows :

I-On --->StoP ---> OFF--->|

|<-----|

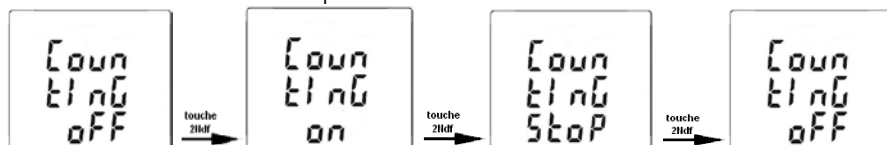

The statuses of the meters are :

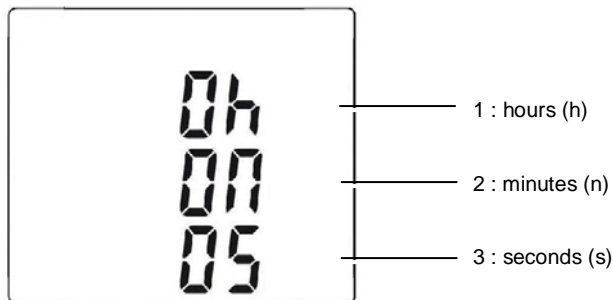

- On <=> metering in operation
- Off <=> metering stopped (values of the meters 0)
- Stop <=> metering stopped (values of the meters preserved)

Hour meter page :



The duration of the metering uses the following format: XXXh (for hours) XXm (for minutes) XXs (for seconds)

N.B. Beyond 999h 59m 59s "---h--m--s" is displayed, but the internal metering duration keeps running correctly.

View of the set of screens concerning the measurement of Energies by short presses on  or  :

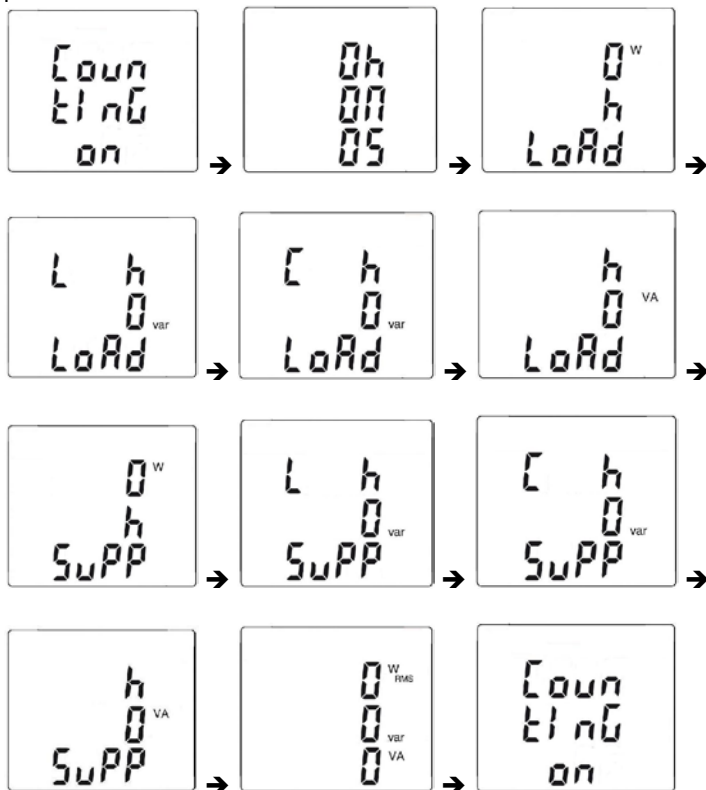

Conventions :

- Load designates the energy received by the load or consumed (W+)
- Load C designates the capacitive reactive energy (W+ and var-)
- Load L designates the inductive reactive energy (W+ and var+)
- Supp designates the energy generated by the load (W-)
- Supp designates the capacitive reactive energy (W- and var-)
- Supp L designates the inductive reactive energy (W- and var+)

7. To access the pages concerning the energies received by the load (« Load side »), press the  key ;

The sequence of use is as follows :

I- Load h W ---> Load L h VAR ---> Load C h VAR ---> Load h VA ---> I  
|-----|

Example of « LOAD side » screen



8. To access the screens concerning the energies generated by the load and therefore received by the source ("Supply side"), press the  key ;

The sequence of use is as follows :

I- Supp h W ---> Supp L h VAR ---> Supp C h VAR ---> Supp h VA ---> I  
|-----|

Example of « SUPP side » screen



The energy displays use the following formats :

- [000.1 ; 999.9]
- [1.000 k ; 9999 k]
- [10.0 M ; 999 M]
- [1.00 G ; 999 G]

### 3.12 FREQUENCY MEASUREMENT (HZ)

The frequency measurement is available in V, W and A for AC and AC+DC quantities. The measurement is based on a count of the passages of the signal through zero (positive-going edges).

#### 3.12.1 Frequency measurement in voltage

To measure the frequency in voltage, proceed as follows:

1. Set the switch to **V<sub>~</sub>** and press the **Hz** key. The Hz symbol is displayed.
2. Select AC by pressing the yellow key until the desired choice is reached.
3. Connect the black lead to the **COM** terminal and the red lead to **+**.
4. Place the test probes or the crocodile clips on the terminals of the circuit to be measured.

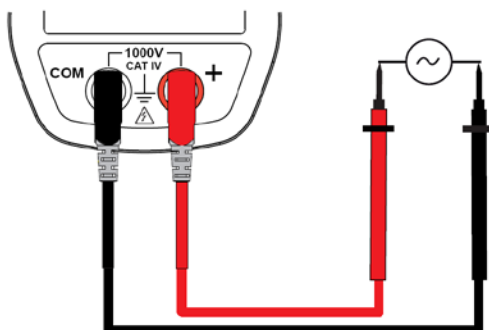

The measured value is displayed on the screen.

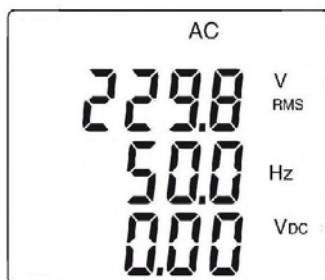

### 3.12.2 Frequency measurement in current

1. Set the switch to **A $\approx$**  and press the **Hz** key. The Hz symbol is displayed.
2. Select AC or AC+DC by pressing the yellow key until the desired choice is reached.
3. Encircle only the conductor concerned with the clamp.

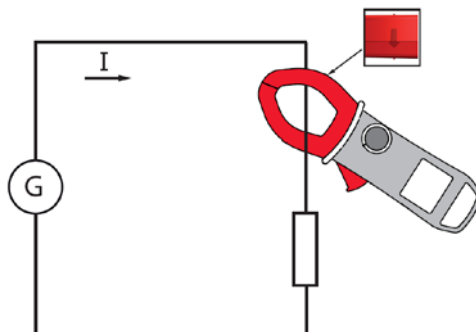

The measured value is displayed on the screen.

### 3.13 MEASUREMENT OF THE TOTAL HARMONIC DISTORTION (THD) AND DISPLAY OF THE ORDERS OF HARMONICS

The device measures the total harmonic distortion with respect to the fundamental (THD<sub>f</sub>), the total harmonic distortion with respect to the true RMS value of the signal (THD<sub>r</sub>) in voltage and in current, then the level (with respect to the fundamental), frequency, and RMS value of each order of harmonic.

The frequency of the fundamental is determined by digital filtering and FFT for the network frequencies of 50, 60, 400, and 800Hz.

#### 3.13.1 Measurement of the THD in voltage

1. Set the switch to **V $\approx$**  and press and hold (>2s) the **Hz** key. The **THD<sub>f</sub>**, **THD<sub>r</sub>** and **V RMS** symbols are displayed.
2. Connect the black lead to the **COM** terminal and the red lead to «+»;
3. Place the test probes or the crocodile clips on the terminals of the circuit to be measured;

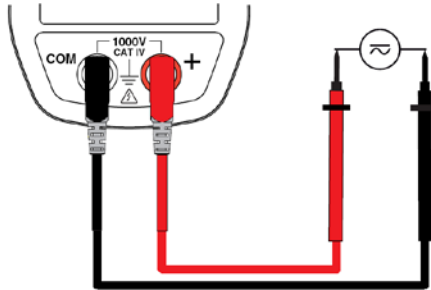

The measurement is displayed on screen.

### 3.13.2 Measurement of the THD in current

1. Set the switch to **A** and press and hold (>2s) the **Hz** key. The **THD<sub>f</sub>**, **THD<sub>r</sub>** and **A RMS** symbols are displayed.
2. Apply the clamp to only the conductor concerned.

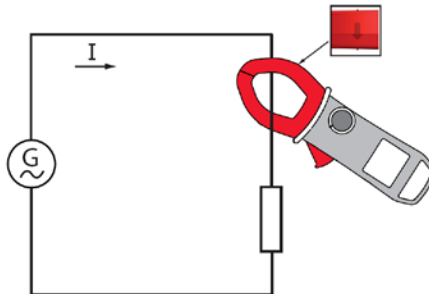

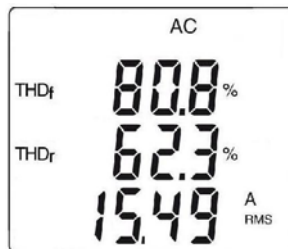

The measurement is displayed on screen.



### 3.13.3 Display of the 25 orders of harmonics and of the frequency of the fundamental

In the context of measurement of the THDs in voltage ( § 3.13.1) and in current ( § 3.13.2) :

1. Press the  key. Order « hDC » is displayed (DC component), only in DC or AC+DC. The harmonics of higher orders are displayed one by one as the  key is pressed repeatedly. The  key can be pressed to return to the previous order

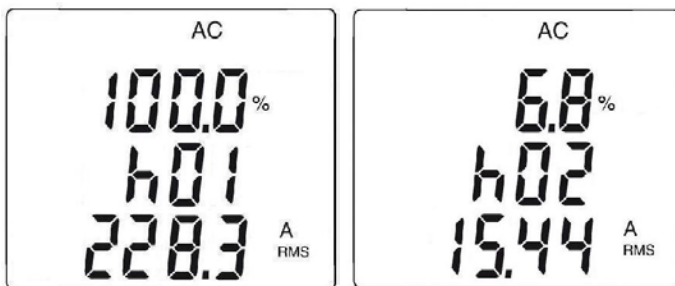

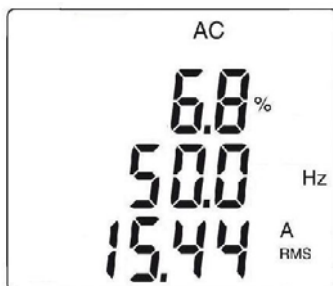

2. The  key can be pressed to display the frequency of the order of harmonic concerned ;





### 3.14 RECORDING OF MEASUREMENT DATA/CAMPAIGNS

The device allows recording of the data/measurements acquired, using the REC function. The default recording interval is 60 seconds. It can be set to from 1 second to 600 seconds (10 minutes) in set-up (see §3.4.3).

1. In the function being measured, apply a long press (> 2s) to the  key. The **REC** symbol is displayed. Recording of the measurements starts. The data recorded are in the format: "MAX value – AVG Value – MIN Value – Unit – Mode" (AC, DC, or AC+DC)
2. To stop recording, apply a long press (>2s) to the  key. The **REC** symbol disappears.

**Caution** : THD recording minimum time interval is 2 s.



**Remarks** : recording is interrupted automatically when the memory of the device is full (REC symbol is flashing) or Bluetooth wireless communication is activated (§3.15)

Type of data	Max. number of records	Max. recording time at 1s intervals	Max. recording time at 600s intervals (10 mn)
<b>V, A, <math>\Omega</math></b>	3000	16 minutes	160 hours
<b>W</b>	3000	3.5 minutes	35 hours
<b>THD</b>	3000	11 minutes (interval 2 s)	55 hours
<b>Harmonics</b>	3000	8 minutes	80 hours

### 3.15 PROCESSING OF THE DATA ON A PC WITH THE PAT SOFTWARE

The device allows wireless transfer of recorded data/measurements (§3.14) to a PC, by means of the Bluetooth function.

The Bluetooth connection must first have been prepared on the PC, which must be on standby.

In the active measurement function, press the  and  keys simultaneously.

The  symbol is displayed. The PC must recognize the device and connect to it :

1. Example of process with Windows XP : Activate the connection Blue-Tooth

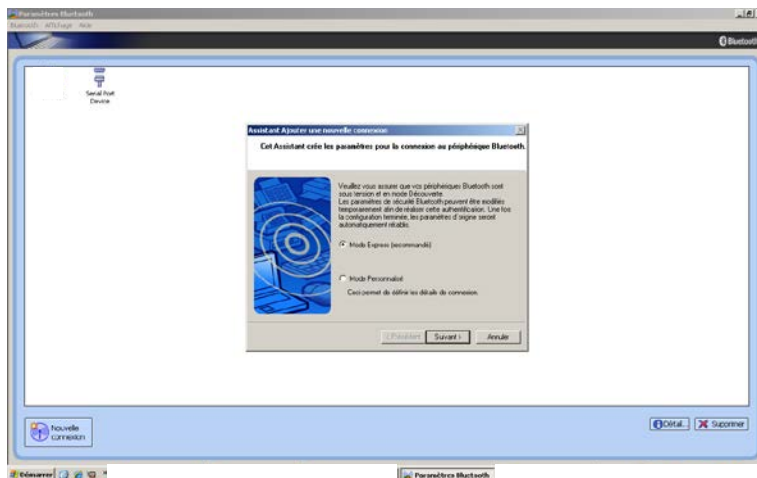

- 1.1 The device was recognized by the PC (METRACLIP 87 on port COM41 in this example) :

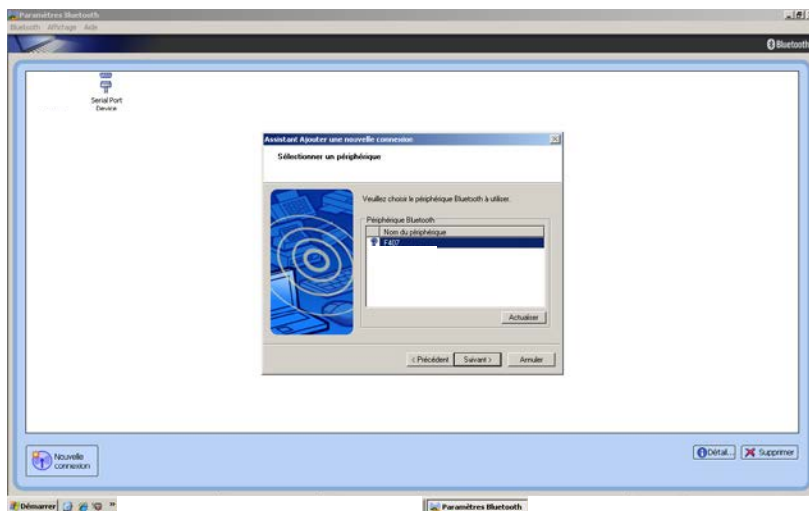

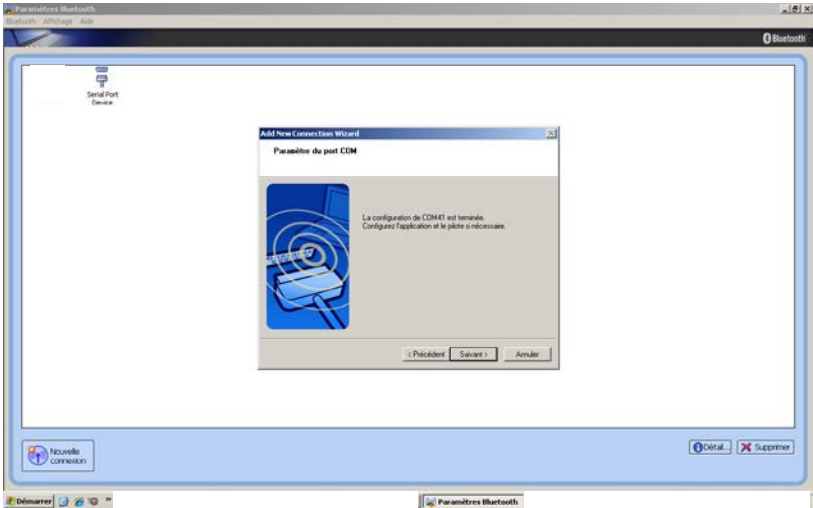

1.2 The device is going to connect with the PC : choose « Connect »

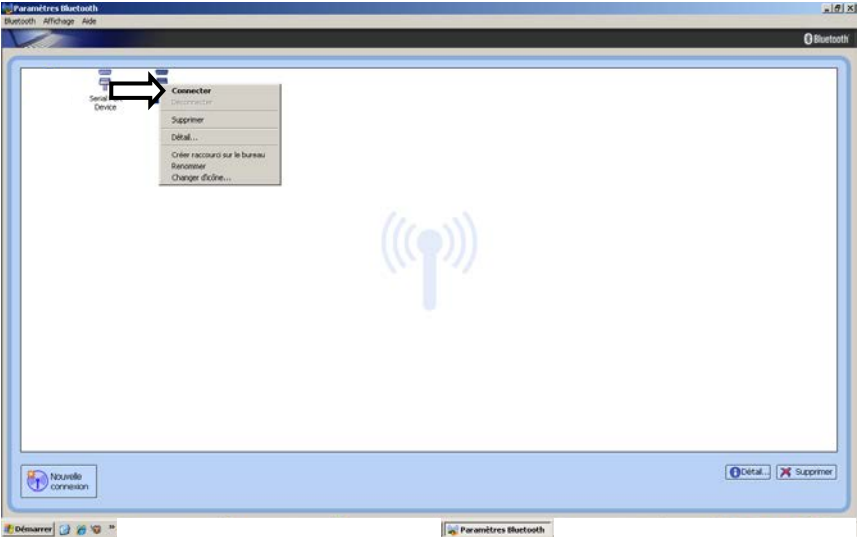

1.3 The device is connected with the PC, after entering password « 0000 » :

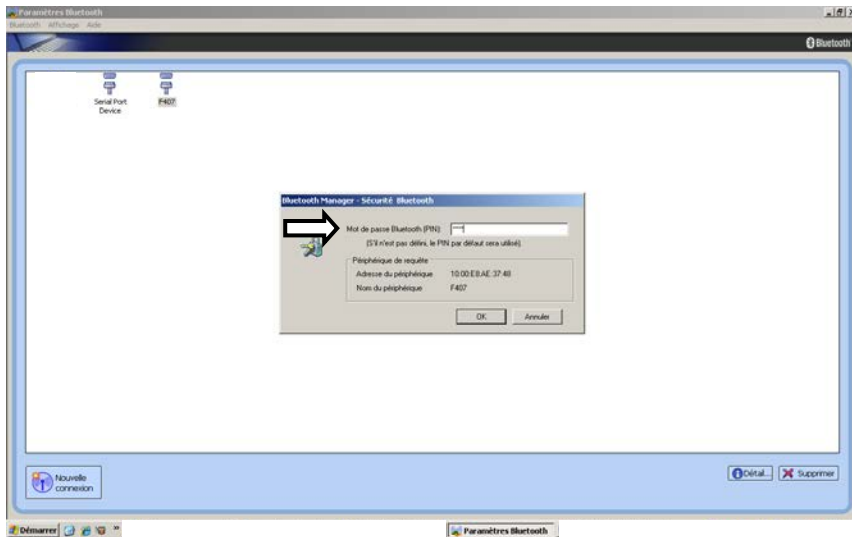

1.4 Device connection in progress with PAT software, with Bluetooth

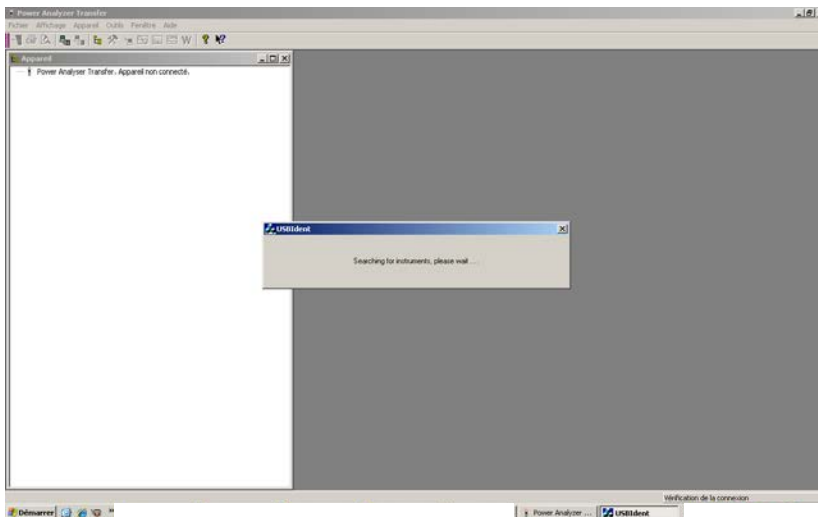

2. Example of process with Windows 7 : choose « Blue-Tooth » symbol and after « Add a device »

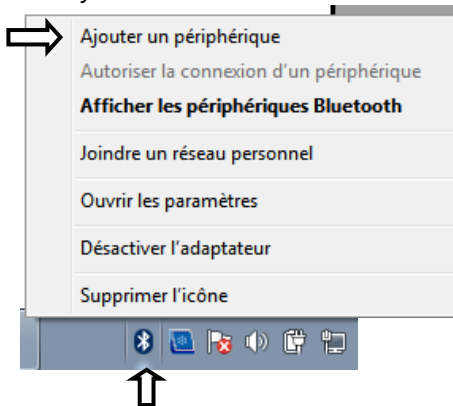

Remark : if the « Blue-Tooth » symbol is not displayed, go to Windows menu and choose « Devices and Printers ». Choose after « Add a device ».

- 2.1 The device was recognized by the PC (F607 in this example) : when the device is detected, choose it and choose after « Next ».

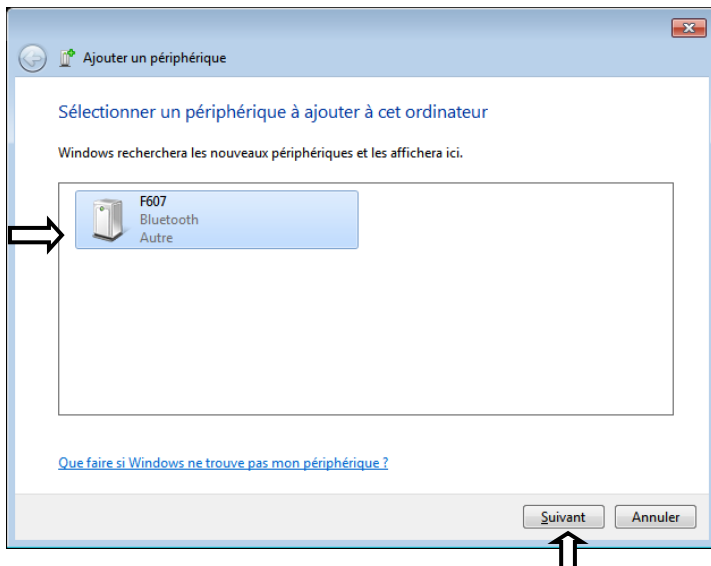

Choose « Associate without using this code ».

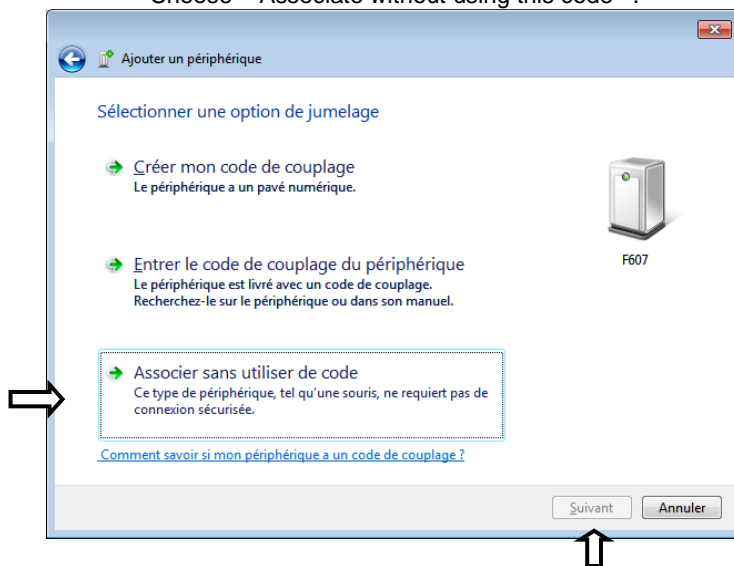

Choose « Next » for connection acceptance.

2.2 The device is going to connect with the PC : choose « Close »

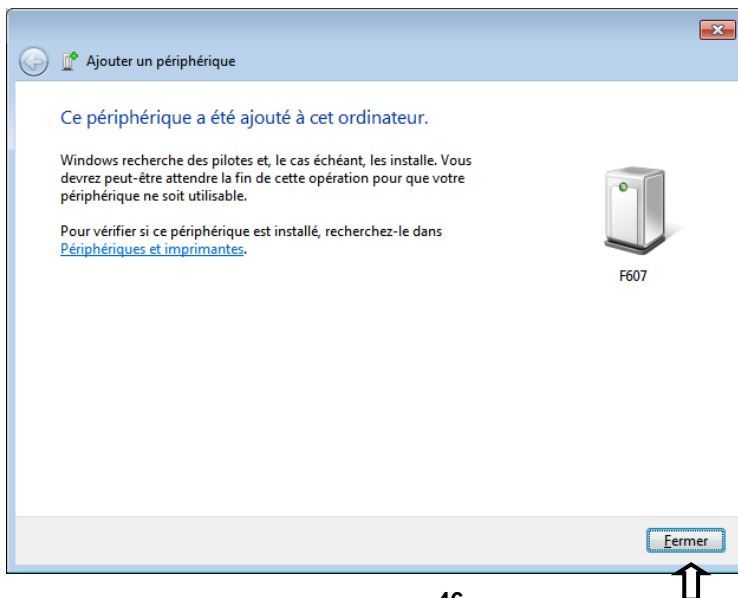

To check the detection, it is necessary to display the « Blue-Tooth » devices. Choose « right clic » in the « Blue-Tooth » symbol and choose « Display Blue-Tooth devices».

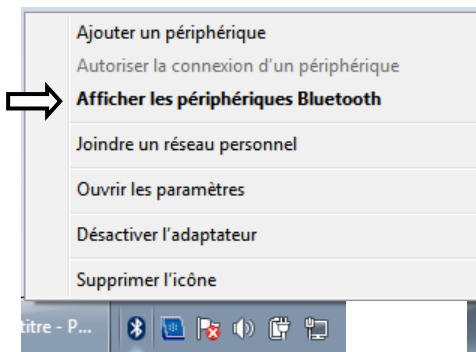

Then choose « Properties » of the device detected by Blue-Tooth (right clic).

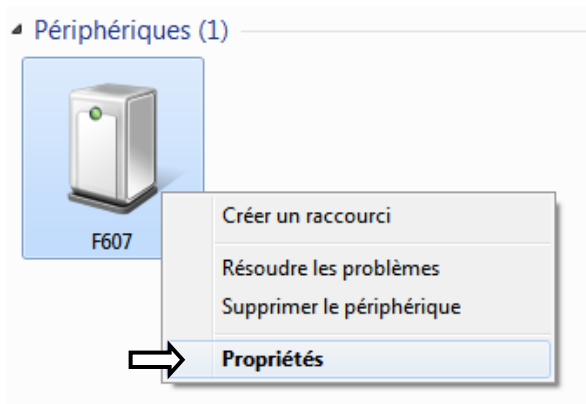

- 1) In the « Matériel » folder, the port COM number dedicated to the device is displayed (COM18 in the example).

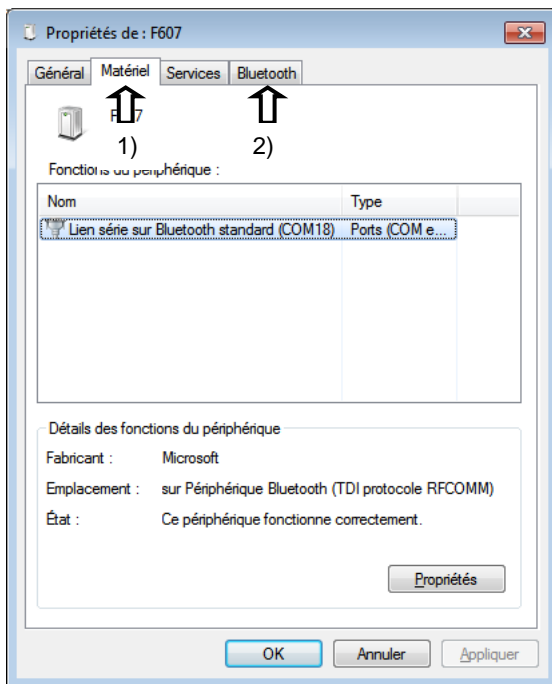

- 2) Under the Bluetooth tab you can assign your own designation (e. g. METRACLIP 87) instead of the default product ID (here : F607).



2.3 Device connection in progress with PAT software, with Bluetooth.  
Choose only « Port COM » to communicate, and choose the good port COM (COM18 here)

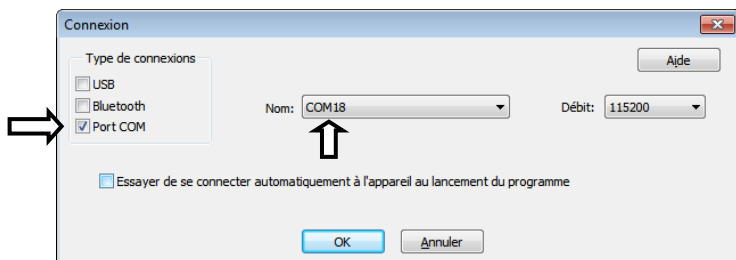

When launching connection, a Windows message prevent a Blue-Tooth connection want to establish :



When choose this message, a windows is displayed to ask device PIN code. You must enter « 0000 ». Then choose « Next » to validate the connection.

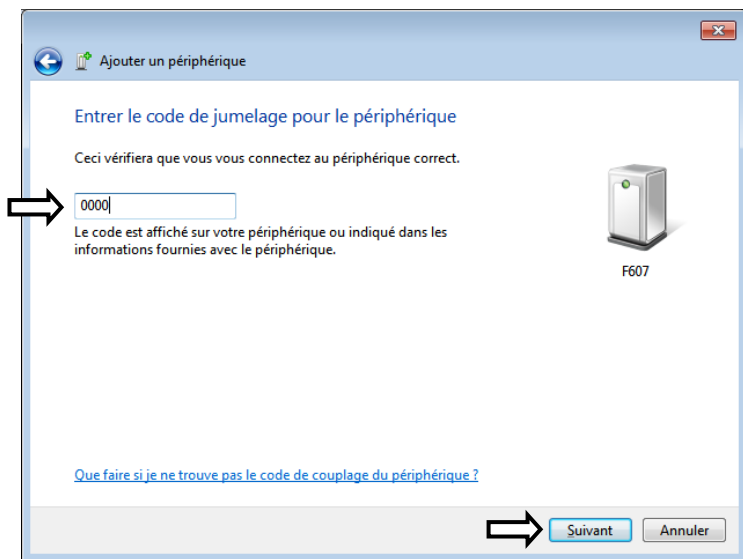

Validate by choosing « Close »

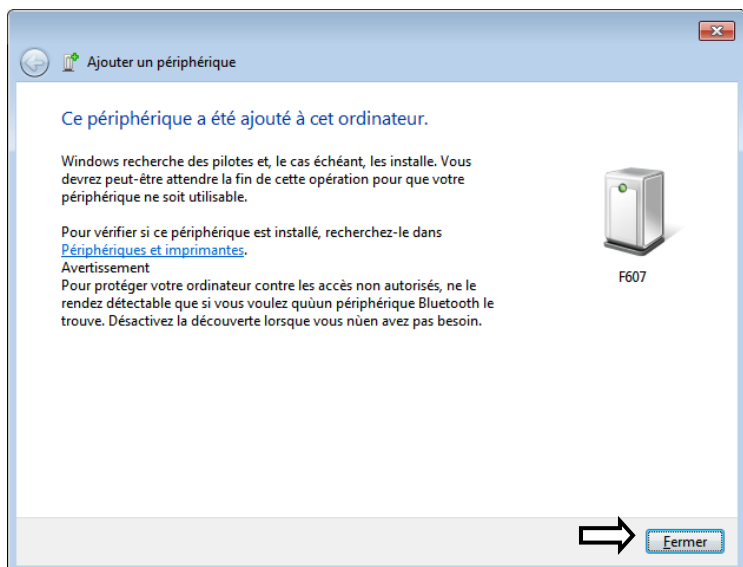

In PAT software, the connection is established. All the informations of the device are displayed in the following windows.

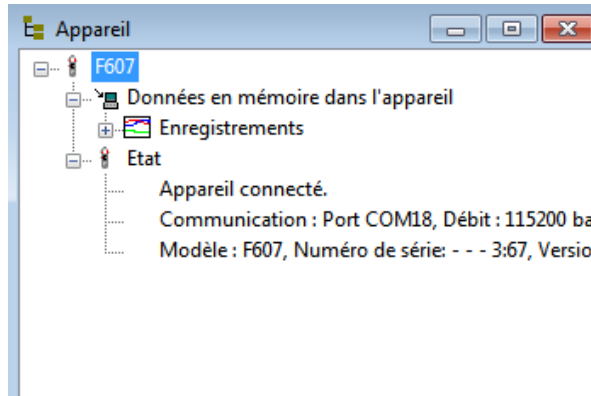

Remark : this process must be made only at the first connection. Parameter are stored in the PC for next connections.

3. Data recorded must be used with the PAT software.

3.1 The device is connected. Display the records stored in the device.  
Select the record to be transferred.

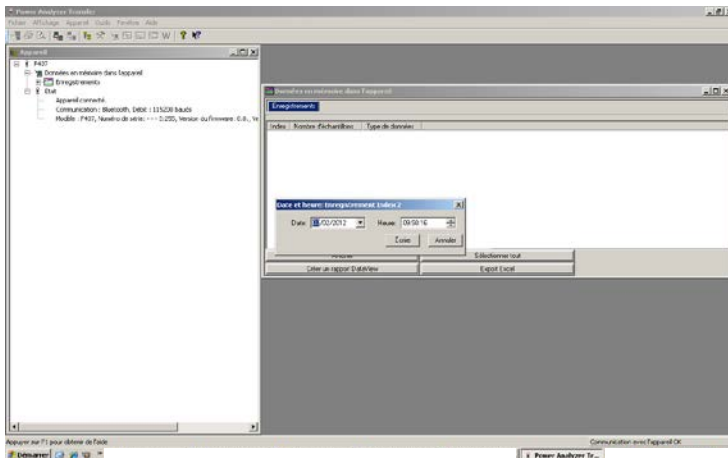

3.2 Transfert of the selected record from the device to PAT software.

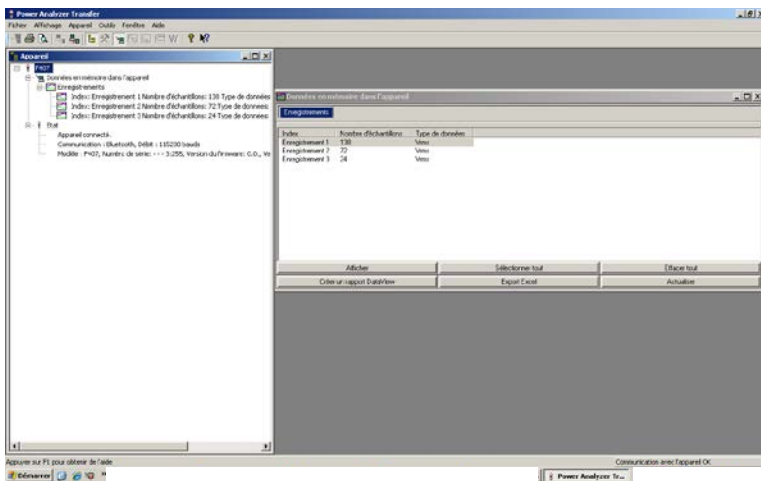

3.3 The data are recovered in PAT software. Display of the data in Text mode, in the format « date – time – MIN – AVG – MAX ».  
*Note : MAX,AVG and MIN values are calculated with values measured between 2 records spaced with record interval value.*

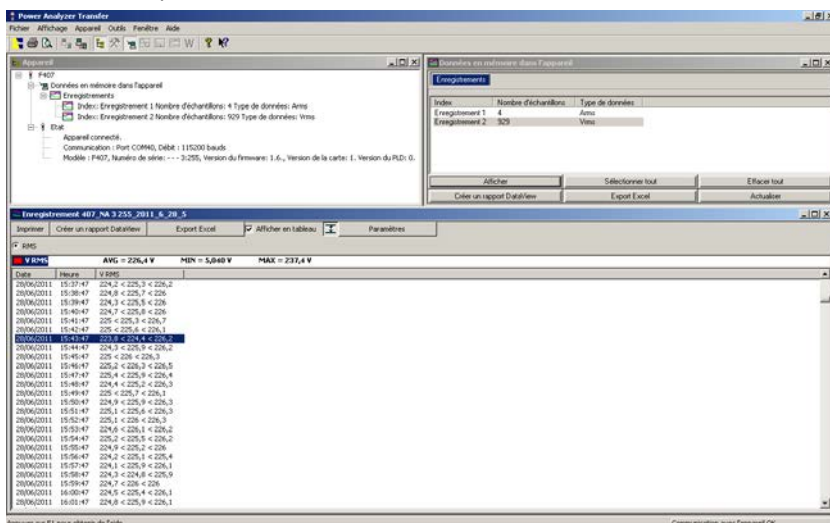

## 3.4 Display of the same data in Graph mode.

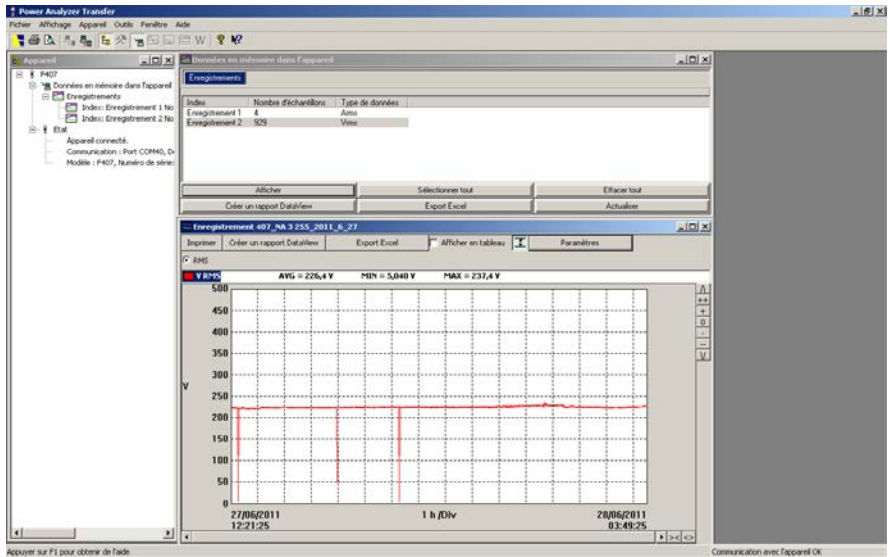

## 3.5 Graph mode enlarged/zoomed.

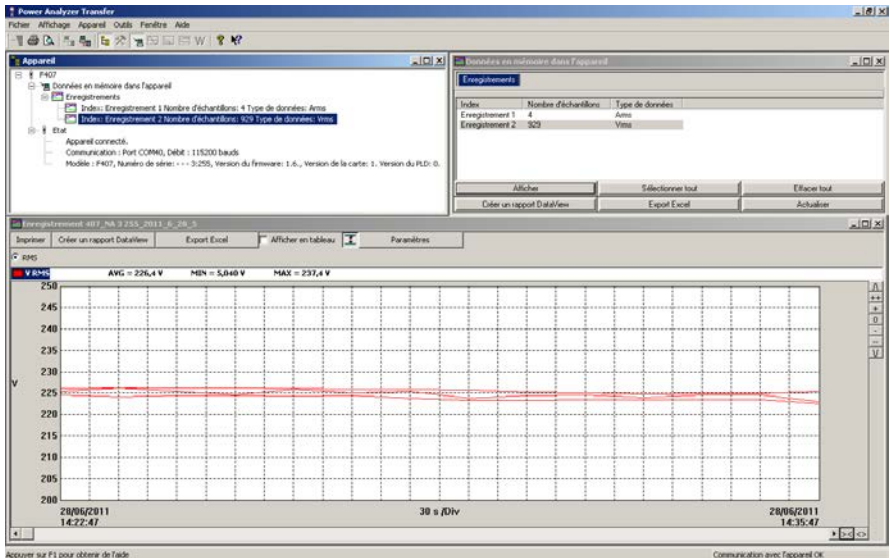

## 3.6 Data are exported to Excel software.

1	A	B	C	D	E	F	G	H	I	J	K	L
1	F407	Numéro de série: ... 3.265		Version de la carte: 1. Version du PLD: 0.								
2	Enregistrement											
3	Date de départ		Date de fin		Heure de fin							
4	28/06/2011	14:33:37	29/06/2011	06:02:37								
5	Type de branchement: Monophasé											
6												
7	Date	Heure	Vrms	Vrms MIN	Vrms MAX							
8			V	V	V							
9	28/06/2011	14:33:37	225,5	224,7	226,2							
10	28/06/2011	14:34:37	226,3	224,2	226,3							
11	28/06/2011	14:35:37	225,6	224,6	226,3							
12	28/06/2011	14:36:37	224,6	224,6	226,3							
13	28/06/2011	14:37:37	226,1	224,5	226,2							
14	28/06/2011	14:38:37	225,3	224,6	226							
15	28/06/2011	14:39:37	225,6	223,9	226,1							
16	28/06/2011	14:40:37	223,9	223,5	226,6							
17	28/06/2011	14:41:37	224,6	223,4	225,4							
18	28/06/2011	14:42:37	224,6	223,6	225,3							
19	28/06/2011	14:43:37	224,1	223,6	224,9							
20	28/06/2011	14:44:37	224,6	223,7	225,1							
21	28/06/2011	14:45:37	224,6	223,7	225,1							
22	28/06/2011	14:45:37	223,2	222,6	225,5							
23	28/06/2011	14:47:37	223,3	222,6	224,3							
24	28/06/2011	14:48:37	223,6	6,26	224,3							
25	28/06/2011	14:49:37	223,6	222,6	224,4							
26	28/06/2011	14:50:37	223,4	222,6	224,1							
27	28/06/2011	14:51:37	223,8	223,1	224,8							
28	28/06/2011	14:52:37	224,8	223,4	225							
29	28/06/2011	14:53:37	224,4	223,9	225							
30	28/06/2011	14:54:37	224,1	223,6	225							
31	28/06/2011	14:55:37	223,2	222,8	224,7							
32	28/06/2011	14:56:37	223,9	223,2	225,1							
33	28/06/2011	14:57:37	224,8	222,7	225,3							
34	28/06/2011	14:58:37	225,1	224,1	225,4							
35	28/06/2011	14:59:37	224,4	223,5	225,2							
36	28/06/2011	15:00:37	225,3	223,6	225,5							
37	28/06/2011	15:01:37	224,2	222,6	225,3							

3.7 To use the files recorded by PAT software on the PC : PAT generate a folder « Dataview\Datafiles\METRACLIP 87 F607 » were Excel files are stored.

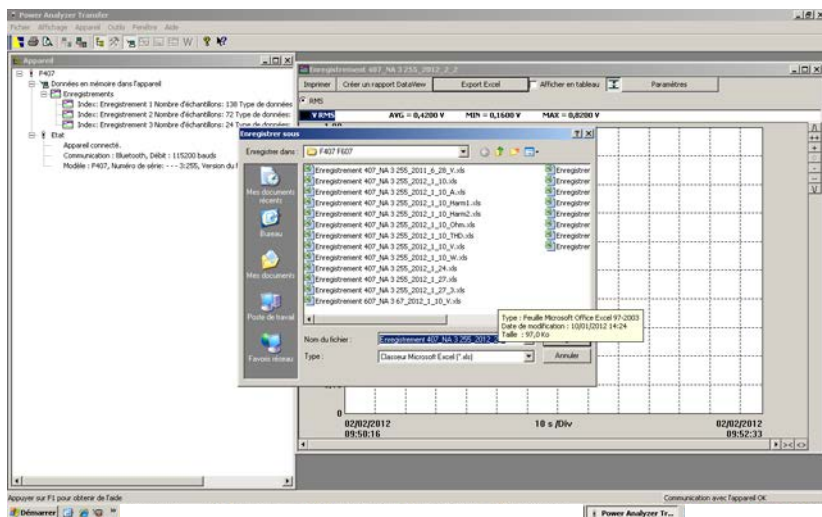

### 3.16 REFERENCE CONDITIONS

Quantities of influence	Reference conditions
Temperature:	23°C ±2°C
Relative humidity:	45% to 75%
Supply voltage:	6.0V ±0.5V
Frequency range of the applied signal:	45–65Hz
Sine wave:	pure
Peak factor of the applied alternating signal:	$\sqrt{2}$
Position of the conductor in the clamp:	centred
Adjacent conductors:	none
Alternating magnetic field:	none
Electric field:	none

### 3.17 CHARACTERISTICS UNDER THE REFERENCE CONDITIONS

The uncertainties are expressed in ± (x% of the reading (R) + y points (pt)).

**3.17.1 DC voltage measurement**

Measurement range	0.00 V to 99.99 V	100.0 V to 999.9 V	1000 V (1)
Specified measurement range	0 to 100% of the measurement range		
Uncertainties	from 0.00V to 9.99V $\pm(1\% R + 10 \text{ pt})$ from 10.00V to 99.99V $\pm(1\% R + 3 \text{ pt})$	$\pm(1\% R + 3 \text{ pt})$	
Resolution	0.01V	0.1V	1V
Input impedance	10M $\Omega$		

**Note (1)** Above 1000V, a repetitive beep indicates that the voltage being measured is greater than the safety voltage for which the device is guaranteed. The display indicates "OL"

**3.17.2 AC voltage measurement**

Measurement range	0.15 V to 99.99 V	100.0 V to 999.9 V	1000 V RMS 1400 V peak (1)
Specified measurement range (2)	0 to 100% of the measurement range		
Uncertainties	from 0.15V to 9.99V $\pm(1\% R + 10 \text{ pt})$ from 10.00V to 99.99V $\pm(1\% R + 3 \text{ pt})$	$\pm(1\% R + 3 \text{ pt})$	
Resolution	0.01V	0.1V	1V
Input impedance	10M $\Omega$		

**Note (1)** -Above 1000V, a repetitive beep indicates that the voltage being measured is greater than the safety voltage for which the device is guaranteed. The display indicates "OL".

- Bandwidth in AC = 3 kHz

**Note (2)** Any value between zero and the min. threshold of the measurement range (0.15V) is forced to "----" on the display



### 3.17.3 AC+DC voltage measurement

Measurement range (2)	0.15V to 99.99V	100.0V to 999.9V	1000V RMS MAX (1) 1400V peak
Specified measurement range	0 to 100% of the measurement range		
Uncertainties	from 0.15V to 9.99V $\pm (1\% R+10 \text{ pt})$ from 10V to 99.99V $\pm (1\% R +3 \text{ pt})$	$\pm (1\% R +3 \text{ pt})$	
Resolution	0.01V	0.1V	1V
Input impedance	10M $\Omega$		

**Note (1)** - The display indicates "OL" above 1400V (in PEAK mode).

- Above 1000V (DC or RMS), a repetitive beep indicates that the voltage being measured is greater than the safety voltage for which the device is guaranteed.
- Bandwidth in AC = 3 kHz

**Note (2)** - Any value between zero and the min. threshold of the measurement range (0.15V) is forced to "----" on the display.

- **Specific characteristics in MAX/MIN mode in tension** (from 10 Hz to 1 kHz in AC and AC+DC):

- Uncertainties: add 1% L to the values in the tables above.
- Capture time of the extrema: approximately 100ms.

- **Specific characteristics in PEAK mode in tension** (from 10 Hz to 400 Hz in AC and AC+DC):

- Uncertainties: add 1.5% L to the values in the tables above.
- PEAK capture time: 1ms min. to 1.5ms max.

### 3.17.4 DC current measurement

Measurement range	0.00A to 99.99A	100.0A to 999.9A	1000A to 1500A (1)
Specified measurement range	0 to 100% of the measurement range		
Uncertainties (2) (zero corrected)	$\pm (1\% R+10 \text{ pt})$	$\pm (1\% R +3 \text{ pt})$	

Resolution	0.01A	0.1A	1A
------------	-------	------	----

**Note (1)** - The display indicates "+OL" above 1500A .

**Note (2)** - The residual current at zero depends on the remanence; It can be corrected by the "DC zero" function of the HOLD key.

### 3.17.5 AC current measurement

Measurement range (2)	0.15 A to 99.99 A	100.0 A to 999.9 A	1000 A (1)
Specified measurement range	0 to 100% of the measurement range		
Uncertainties	$\pm (1\% R + 10 \text{ pt})$	$\pm (1\% R + 3 \text{ pt})$	
Resolution	0.01A	0.1A	1A

**Note (1)** - The display indicates "OL" above 1500A (in PEAK mode). The "-" and "+" signs are not managed.

- Bandwidth in AC = 2 kHz

**Note (2)** - Any value between zero and the min. threshold of the measurement range (0.15V) is forced to "----" on the display.

- Residual current at zero <150mA..

### 3.17.6 AC+DC intensity measurement

Measurement range (2)	0.15A to 99.99A	100.0A to 999.9A	AC: 1000A DC or PEAK: 1000A to 1500A (1)
Specified measurement range	0 to 100% of the measurement range		

Uncertainties (2) (zero corrected)	$\pm (1\% R + 10 \text{ pt})$	$\pm (1\% R + 3\text{pt})$	
Resolution	0.01A	0.1A	1A

**Note (1)** - The display indicates "+OL" above 1500A (in PEAK mode). The "-" and "+" signs are not managed.

- Bandwidth in AC = 2 kHz

**Note (2)** - In AC, any value between zero and the min. threshold of the measurement range (0.15A) is forced to "----" on the display.

- Residual current at zero:

- In DC: depends on the remanence. Can be corrected by the "DC zero" function of the HOLD key
- In AC: <150mA

- **Specific characteristics in MAX/MIN mode in current** (from 10 Hz to 1 kHz in AC and AC+DC):

- Uncertainties: add 1% R to the values in the tables above.
- Capture time of the extrema: approximately 100ms.

- **Specific characteristics in PEAK mode in current** (from 10 Hz to 400 Hz in AC and AC+DC):

- Uncertainties: add 1.5% L to the values in the tables above.
- PEAK capture time: 1ms min. to 1.5ms max.

### 3.17.7 True-Inrush measurement

Measurement range	10 A to 1000 A AC	10 A to 1500 A DC
Specified measurement range	0 to 100% of the measurement range	
Uncertainties	$\pm (5\% R + 5 \text{ pt})$	
Resolution	1 A	

**Specific characteristics in PEAK mode in True-Inrush** (from 10 Hz to 400 Hz in AC):

- Uncertainties: add  $\pm (1.5\% L + 0.5A)$  to the values in the tables above.
- PEAK capture time: 1ms min. to 1.5ms max.

### 3.17.8 Calculation of the crest factor (CF)

Measurement range	1.00 – 3.50	3.51 – 5.99	6.00 – 10.00
-------------------	-------------	-------------	--------------

Specified measurement range (from 5V or 5A)	0 to 100% of the measurement range		
Uncertainties (zero corrected in A DC)	$\pm (2\% R + 2 \text{ pt})$	$\pm (5\% R + 2 \text{ pt})$	$\pm (10\% R + 2 \text{ pt})$
Resolution	1 pt		

**Remark :** Peak values limited to 1500V or 1500A  
Uncertainties guaranteed until 400 Hz

### 3.17.9 Calculation of the RIPPLE in DC

Measurement range	0,1% - 99,9%	100,0% - 1000%
Specified measurement range (from 3 A DC and 2 V DC)	2 to 100% of the measurement range	0 to 100% of the measurement range
Uncertainties	$\pm (5\% R + 10 \text{ pt})$	
Resolution	0,1	

**Remark :** If one of the terms for the calculation of the RIPPLE is displayed as "OL", or forced to zero, the RIPPLE displayed is an indeterminate value, "----".

### 3.17.10 Continuity measurement

Measurement range	0.0 $\Omega$ to 999.9 $\Omega$
Open-circuit voltage	$\leq 3.6\text{V}$
Measurement current	550 $\mu\text{A}$
Uncertainties	$\pm (1\% R + 5 \text{ pt})$
Buzzer triggering threshold	40 $\Omega$

### 3.17.11 Resistance measurement

Measurement range (1)	0.0 $\Omega$ to 999.9 $\Omega$	1000 $\Omega$ to 9999 $\Omega$	10.00 k $\Omega$ to 99.99 k $\Omega$
Specified measurement range	1 to 100% of the measurement range	0 to 100% of the measurement range	
Uncertainties	$\pm (1\% R + 5 \text{ pt})$		
Resolution	0.1 $\Omega$	1 $\Omega$	10 $\Omega$
Open-circuit voltage	$\leq 3.6\text{V}$		
Measurement current	550 $\mu\text{A}$	100 $\mu\text{A}$	10 $\mu\text{A}$

**Note (1)** - Above the maximum display value, the display unit indicates "OL".

The "-" and "+" signs are not managed.

#### Specific characteristics in MAX/MIN mode:

- Uncertainties: add 1% R to the values of the table above.
- Capture time of the extrema: approximately 100ms.

### 3.17.12 Active DC power measurements

Measurement range (2)	0 W to 9999W	10,00 kW to 99,99kW	100,0 kW to 999,9 kW	1000 kW to 1500 kW (1)
Specified measurement range	1 to 100% of the measurement range	0 to 100% of the measurement range		
Uncertainties (3)	until 1000A ± (2% R +10 pt) from 1000A to 1500A ± (2.5% R +10 pt)	until 1000A ± (2% R +3 pt) from 1000A to 1500A ± (2.5% R +3 pt)		
Resolution	1W	10W	100W	1000W

**Note 1** - Display of O.L above 1500kW in single-phase (1000V x 1500A).

**Note 2** - Any applied voltage greater than 1000V causes the emission of an intermittent alarm beep to report a dangerous overload.

**Note 3** - The measurement result may be perturbed by an instability linked to the current measurement (approximately 0.1A).

Example: for a power measurement made at 10A, the instability of the measurement will be 0.1A/10A or 1%.

### 3.17.13 Active AC power measurements

Measurement range (2) (4)	5 W to 9999 W	10,00 kW to 99,99 kW	100,0 kW to 999,9 kW	1000 kW (1)
Specified measurement range	1 to 100% of the measurement range	0 to 100% of the measurement range		
Uncertainties (3) (7)	± (2% R +10 pt)	± (2% R +3 pt)		
Resolution	1W	10W	100W	1000W

**Note (1)** - Display of O.L or ± O.L above 1000 kW in single-phase (1000V x 1000A).  
- Bandwidth in AC in voltage = 3 kHz, in current = 2 kHz

**Notes (2) and (3)** of the previous § apply.

**Note (4)** - Any power measured less than  $\pm 5W$  is regarded as zero and causes the display of dashes "----"

- If the voltage is less than 0.15V or if the current is less than 0.15A, the power measured is regarded as zero and causes the display of dashes "----"

**Note 5** - The active powers are positive for power consumed and negative for power generated.

**Note 6** - The signs of the active and reactive powers and power factor are defined by the four-quadrant rule below:

- The diagram below sums up the signs of the power as a function of the phase angle between  $U$  and  $I$ :

Quadrant 1 : Active power $P$	sign + (power consumed)
Quadrant 2 : Active power $P$	sign - (power generated)
Quadrant 3 : Active power $P$	sign - (power generated)
Quadrant 4 : Active power $P$	sign + (power consumed)

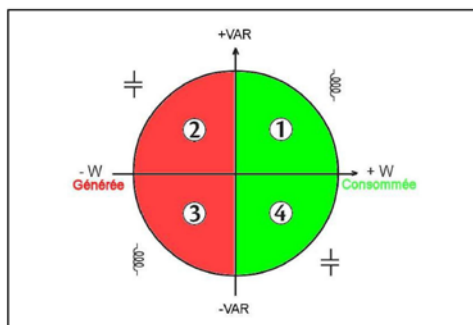

**Note (7)** - In balanced three-phases, with deformed signals (THD and harmonics), uncertainties are guaranteed since  $\Phi > 30^\circ$ . Additional errors are following, depending of THD :

Add +1% for  $10\% < THD < 20\%$

Add +3% for  $20\% < THD < 30\%$

Add +5% for  $30\% < THD < 40\%$

### 3.17.14 Active AC+DC power measurements

Measurement range (2) (4)	5 W to 9999 W	10,00 kW to 99,99 kW	100,0 kW to 999,9 kW	1000 kW to 1500 kW (1)
---------------------------	---------------	----------------------	----------------------	------------------------

Specified measurement range	1 to 100% of the measurement range	0 to 100% of the measurement range		
Uncertainties (3) (7)	until 1000A $\pm (2\% R + 10 \text{ pt})$ from 1000A to 1500A $\pm (2.5\% R + 10 \text{ pt})$	until 1000A $\pm (2\% R + 3 \text{ pt})$ from 1000A to 1500A $\pm (2.5\% R + 3 \text{ pt})$		
Resolution	1W	10W	100W	1000W

**Note (1)** - Display of O.L above 1500kW in single-phase (1000V x 1500A).  
- Bandwidth in AC in voltage = 3 kHz, in current = 2 kHz

**Notes (2), (3), (4), 5, 6 and (7)** of the previous § apply.

### 3.17.15 Measurement of apparent AC power

Measurement range (2) (4)	5 VA to 9 999 VA	10,00 kVA to 99,99 kVA	100,0 kVA to 999,9 kVA	1000 kVA (1)
Specified measurement range	1 to 100% of the measurement range	0 to 100% of the measurement range		
Uncertainties (3)	$\pm (2\% R + 10 \text{ pt})$	$\pm (2\% R + 3 \text{ pt})$		
Resolution	1VA	10VA	100VA	1000VA

**Note (1)** - Display of O.L above 1000 kVA in single-phase (1000 V x 1000 A).  
- Bandwidth in AC in voltage = 3 kHz, in current = 2 kHz

**Notes (2), (3) and (4)** of the previous § apply.

### 3.17.16 Measurement of apparent AC+DC power

Measurement range(2) (4)	5 VA to 9999 VA	10,00 kVA to 99,99 kVA	100,0 kVA to 999,9 kVA	1000 kVA to 1500 kVA (1)
Specified measurement range	1 à 100% of the measurement range	0 to 100% of the measurement range		

Uncertainties (3)	until 1 000 A $\pm (2\% R + 10 \text{ pt})$ from 1000 A to 1500 A $\pm (2,5\% R + 10 \text{ pt})$	until 1 000 A $\pm (2\% R + 3 \text{ pt})$ from 1000 A to 1500 A $\pm (2,5\% R + 3 \text{ pt})$		
Resolution	1 VA	10 VA	100 VA	1 000 VA

**Note (1)** - Display of O.L above 1500 kVA in single-phase (1000 V x 1500 A).  
- Bandwidth in AC in voltage = 3 kHz, in current = 2 kHz

**Notes (2), (3) and (4)** of the previous § apply.

### 3.17.17 Measurement of reactive AC power

Measurement range (2) (4)	5 var to 9999 var	10,00 kvar to 99,99 kvar	100,0 kvar to 999,9 kvar	1000 kvar (1)
Specified measurement range	1 to 100% of the measurement range	0 to 100% of the measurement range		
Uncertainties (3) (8)	$\pm (2\% R + 10 \text{ pt})$	$\pm (2\% R + 3 \text{ pt})$		
Resolution	1 var	10 var	100 var	1 kvar

**Note (1)** - Display of O.L above 1000 kvar in single-phase (1000 V x 1000 A).  
- Bandwidth in AC in voltage = 3 kHz, in current = 2 kHz

**Notes (2), (3) and (4)** of the previous § apply.

**Note 5** - In single-phase, the sign of the reactive power is determined by the phase lead or lag between the U and I signs, while in balanced three-phase, it is determined by the calculation on the samples.

**Note 6** - Signs of reactive powers according to the four-quadrant rule (§4.2.12):  
 Quadrant 1 : Reactive power Q sign +  
 Quadrant 2 : Reactive power Q sign +  
 Quadrant 3 : Reactive power Q sign -  
 Quadrant 4 : Reactive power Q sign -

**Note (8)** - Measurement stabilization ~8 sec



### 3.17.18 Measurement of reactive AC+DC power

Measurement range (2) (4)	5 var to 9999 var	10,00kvar to 99,99kvar	100,0kvar to 999,9kvar	1000kvar to 1500kvar (1)
Specified measurement range	1 to 100% of the measurement range	0 to 100% of the measurement range		
Uncertainties (3) (8)	until 1000A $\pm (2\% R + 10 \text{ pt})$ from 1000A to 1500A $\pm (2.5\% R + 10 \text{ pt})$	until 1000A $\pm (2\% R + 3 \text{ pt})$ from 1000A to 1500A $\pm (2.5\% R + 3 \text{ pt})$		
Resolution	1 var	10 var	100 var	1 kvar

**Note (1)** - Display of O.L above 1500 kvar in single-phase (1000 V x 1500 A).  
- Bandwidth in AC in voltage = 3 kHz, in current = 2 kHz

**Notes (2), (3), (4), 5, 6 and (8)** of the previous § apply.

- **Specific characteristics in MAX/MIN mode in power** (from 10Hz to 1kHz in AC and AC+DC):

- Uncertainties: add 1 %R to the values in the tables above.
- Capture time: approximately 100ms

### 3.17.19 Calculation of the power factor (PF)

Measurement range (1)	0.00 to +1.00	
Specified measurement range	0 to 50% of the measurement range	50 to 100% of the measurement range
Uncertainties (7)	$\pm (3\% R + 3 \text{ pt})$	$\pm (2\% R + 3 \text{ pt})$
Resolution	0.01	

**Note (1)** - If one of the terms in the calculation of the power factor is displayed as "OL", or forced to zero, the display of the power factor is an indeterminate value "----".

**Note (7)** of the previous § apply.

**Remark :** The PF is always positive

- **Specific characteristics in MAX/MIN mode** (from 10Hz to 1kHz):

- Uncertainties: add 1 %R to the values in the tables above.
- Capture time: approximately 100ms.

### 3.17.20 Calculation of the displacement power factor (DPF)

Measurement range (1)	0.00 to +1.00
Specified measurement range (from 1 A AC)	0 to 100% of the measurement range
Uncertainties (2) (7)	$\pm (5\% R + 2 \text{ pt})$
Resolution	0.01

**Note (1)** - If one of the terms in the calculation of the DPF is displayed as "OL", or forced to zero, the display of the DPF is an indeterminate value "----".

**Note (2)** - Measurement stabilization ~8 sec

**Note (7)** of the previous § apply.

**Remark :** The DPF is always positive

- **Specific characteristics in MAX/MIN mode** (from 10Hz to 1kHz):

- Uncertainties: add 1 %R to the values in the tables above.
- Capture time: approximately 100ms.

### 3.17.21 Frequency measurements

#### 3.17.21.1 Characteristics in voltage

Measurement range (1)	5.0 Hz to 999.9 Hz	1000 Hz to 9999 Hz	10.00 kHz to 19.99 kHz
Specified measurement range	1 to 100% of the measurement range	0 to 100% of the measurement range	
Uncertainties	$\pm (0.4\% R + 1 \text{ pt})$		
Resolution	0.1 Hz	1 Hz	10 Hz

#### 3.17.21.2 Characteristics in current

Measurement range (1)	5.0 Hz to 1999 Hz
Specified measurement range	1 to 100% of the measurement range
Uncertainties	$\pm (0.4\% R + 1 \text{ pt})$
Resolution	0.1Hz

**Note (1)** in MAX/MIN mode, the operating range is limited to 1kHz.

- If the level of the signal is too low (<10% of the range, or  $U < 8V$  or  $I < 9A$ ) or if the frequency is less than 5Hz, the device cannot determine the frequency and displays dashes "----"

**Specific characteristics in MAX/MIN mode MAX-MIN** (from 10Hz to 1kHz):

- Uncertainties: add 1% R to the values of the table above.
- Capture time of the extrema: approximately 100ms.

### 3.17.22 Characteristics in THDr

Measurement range	0.0–100%
Specified measurement range	0 to 100% of the measurement range
Uncertainties	$\pm$ (5% R $\pm$ 2 pts) in voltage $\pm$ (5% R $\pm$ 5 pts) in current
Resolution	1%

### 3.17.23 Characteristics in THDf

Measurement range	0.0–1.000%
Specified measurement range	0 to 100% of the measurement range
Uncertainties	$\pm$ (5% R $\pm$ 2 pts) in voltage $\pm$ (5% R $\pm$ 5 pts) in current
Resolution	1%

 **Note** : - The display is "----" if the input signal is too low ( $U < 8V$  or  $I < 9A$ ) or if the frequency is less than 5Hz.

- Specific characteristics in MAX/MIN mode in THD (from 10Hz to 1kHz):
  - Uncertainties: add 1% R to the values in the tables above.
  - Capture time of the extrema: approximately 100ms

### 3.17.24 Harmonic measurement characteristics

Measurement range in voltage	Per §4.2.2 and §4.2.3
Measurement range in current	Per §4.2.5 and §4.2.6
Range of use in harmonic	AC: harmonics of orders 1 to 25 AC+DC: all orders from 1 to 25, plus the DC component

Frequency analysis band	- 0 to 25 times the fundamental frequency, from among the network frequencies 50, 60, and 400Hz - 0 to 12 times the fundamental frequency of an 800Hz network
Stability of the current and voltage display	$\pm (1\% R \pm 2 \text{ pts})$
Uncertainties on the RMS value of the harmonic (zero corrected in A DC)	Level >10% and order <13: $\pm(5\% R \pm 2 \text{ pts})$ Level >10% and order >13: $\pm(10\% R \pm 2 \text{ pts})$ Level <10% and order <13: $\pm(10\% R \pm 2 \text{ pts})$ Level <10% and order >13: $\pm(15\% R \pm 2 \text{ pts})$

 **Note** : - The display is "----" if the input signal is too low ( $U < 8V$  or  $I < 9A$ ) or if the frequency is less than 5Hz.

- **Specific characteristics in MAX/MIN mode in THD** (from 10Hz to 1kHz):

- Uncertainties: add 1% R to the values in the tables above.
- Capture time of the extrema: approximately 100ms

### 3.18 ENVIRONMENTAL CONDITIONS

Environmental conditions	in use	in storage
Temperature	-20 C to + 55 C	-40 °C to + 70°C
Relative humidity (RH):	$\leq 90\%$ at 55°C	$\leq 90\%$ up to 70° C

### 3.19 CHARACTERISTICS OF CONSTRUCTION

Housing:	Rigid polycarbonate shell with moulded elastomer covering
	Polycarbonate
Jaws:	Opening: 48 mm Clamping diameter: 48 mm
	LCD display unit
Screen:	Blue backlighting Dimension: 41 x 48 mm
Dimension:	H-272 x W-92 x D-41mm
Weight:	600g (with the batteries)

### 3.20 POWER SUPPLY

Batteries:	4x1,5V LR6
Mean life:	>350 hours (without backlighting and without Blue-tooth wireless)
Duration of operation before automatic switching off:	After 10 minutes without action on the switch and/or keys

### 3.21 COMPLIANCE WITH INTERNATIONAL STANDARDS

Electric safety:	Compliant with standards IEC-61010-1, IEC-61010-2-30, and IEC-61010-2-32: 1000V CAT-IV.
Electromagnetic compatibility:	Compliant with standard EN-61326-1 Classification: residential environment
Mechanical strength:	Free fall: 2m (in accordance with standard IEC-68-2-32)
Level of protection of the housing:	Housing: IP54 (per standard IEC-60529) Jaws: IP40

### 3.22 VARIATIONS IN THE DOMAIN OF USE

Quantity of influence	Range of influence	Quantity influenced	Influence	
			Typical	MAX
Temperature	-20...+55°C	V AC	-	0.1%R/10°C
		V DC	0.1%R/10°C	0.5%R/10°C + 2pts
		A*	1%R/10°C*	1.5%R/10°C + 2pts*
		$\Omega$ 	-	0.1%R/10°C + 2 pts
		W AC	-	0.2%R/10°C + 2 pts
		W DC	0.15%R/10°C	0.3%R/10°C + 2 pts
Humidity	10%...90%HR	V	≤ 1 pt	0.1%R + 1 pt

		A $\Omega$  W	- 0.2%R 0.25%R	0.1%R + 2 pts 0.3%R + 2 pts 0.5%R + 2 pts
Frequency	10 Hz...1 kHz 1 kHz...3 kHz 10 Hz...400 Hz 400 Hz...2 kHz	V  A	1%R + 1 pt 8%R + 1 pt 1%R + 1 pt 4%R + 1 pt	1%R + 1 pt 9%R + 1 pt 1%R + 1 pt 5%R + 1 pt
Position of the conductor in the jaws ( $f \leq 400$ Hz)	Any position on the internal perimeter of the jaws	A-W	2%R	4%R + 1 pt Full-scale
Adjacent conductor carrying a current of 150 A DC or RMS	Conductor touching the external perimeter of the jaws	A-W	40 dB	30 dB
Conductor enclosed by the clamp	0-500 A DC or RMS	V	< 1 pt	1 pt
Application of a voltage of the clamp	0-1000 V DC or RMS	A-W	< 1 pt	1 pt
Peak factor (1)	1.4 to 3.5 limited to 1500 A peak 1400 V peak	A (AC-AC+DC) V (AC-AC+DC)	1%R 1%R	3%R + 1 pt 3%R + 1 pt
PF (inductive and capacitive)	0.7 and $I \geq 5A$ 0.5 and $I \geq 10A$ 0.2 and $I \geq 20A$	W	0.5%R	1%R + 1 pt 3%R + 1 pt 8%R + 1 pt

Nota\* in Temperature : Influence specified until 1000 A DC

## 4 MAINTENANCE

The instrument has no parts that can be replaced by personnel who are not trained and approved. Any non-approved repair or other work, or replacement of a part by an "equivalent", may severely compromise safety.

### 4.1 CLEANING

- Disconnect everything connected to the device and set the switch to OFF.
- Use a soft cloth moistened with soapy water. Rinse with a damp cloth and dry quickly using a dry cloth or forced air.
- Dry perfectly before putting back into use.

### 4.2 REPLACEMENT OF THE BATTERIES

The  symbol indicates that the batteries are spent. When this symbol appears on the display unit, the batteries must be replaced. The measurements and specifications are no longer guaranteed.

To replace the batteries, proceed as follows:

1. Disconnect the measurement leads from the input terminals.
2. Set the switch to OFF.
3. Use a screwdriver to unscrew the screw securing the battery compartment cover to the back of the housing and open the cover (see [§3.1](#)).
4. Replace all of the batteries (see [§3.1](#)).
5. Close the cover and screw it to the housing.

### 4.3 METROLOGICAL CHECK

Like all measuring or testing devices, the instrument must be checked regularly. This instrument should be checked at least once a year. For checks and calibrations, contact one of our accredited metrology laboratories (information and contact details available on request), at our GOSSEN METRAWATT subsidiary or the branch in your country.

### 4.4 REPAIR

For all repairs before or after expiry of warranty, please return the device to your distributor.

## 5 WARRANTY

---

Except as otherwise stipulated, our warranty is valid for three years starting from the date on which the equipment was sold. Extract from our General Conditions of Sale provided on request.

The warranty does not apply in the following cases:

- Inappropriate use of the equipment or use with incompatible equipment;
- Modifications made to the equipment without the explicit permission of the manufacturer's technical staff;
- Work done on the device by a person not approved by the manufacturer;
- Adaptation to a particular application not anticipated in the definition of the equipment or not indicated in the user's manual;
- Damage caused by shocks, falls, or floods.

## 6 DELIVERY CONDITION

---

The **METRACLIP 87** clamp multimeter is delivered in its packaging box with :

- 2 banana-banana leads, one red and one black
- 2 test probes, one red and one black
- 1 red crocodile clip
- 1 black crocodile clip
- 4 1.5V batteries
- 1 carrying bag
- the user guide in multilingual, on a mini-CD
- multilingual PAT software for PC on mini-CD
- the getting started guide in multilingual



## 7 ADDRESSES

---

### **Repair and Replacement Parts Service Calibration Center and Rental Instrument Service**

If required, please contact:

GMC-I Service GmbH

#### **Service-Center**

Thomas-Mann-Strasse 20  
90471 Nürnberg • Germany

Phone +49 911 817718-0

Fax +49 911 817718-253

E-Mail [service@gossenmetrawatt.com](mailto:service@gossenmetrawatt.com)

[www.gmci-service.com](http://www.gmci-service.com)

This address is only valid in Germany.

Please contact our representatives or subsidiaries for service in other countries.

### **Product Support**

If required, please contact:

GMC-I Messtechnik GmbH

#### **Product Support Hotline**

Phone +49 911 8602-0

Fax +49 911 8602-709

E-Mail [support@gossenmetrawatt.com](mailto:support@gossenmetrawatt.com)

07 - 2013  
Code : 693111A02 - Ed. 3

---

Subject to change without notice • A pdf version is available on the Internet

 **GOSSEN METRAWATT**  
GMC-I Messtechnik GmbH  
Südwestpark 15  
90449 Nürnberg • Germany

Phone +49 911 8602-111  
Fax +49 911 8602-777  
E-Mail [info@gossenmetrawatt.com](mailto:info@gossenmetrawatt.com)  
[www.gossenmetrawatt.com](http://www.gossenmetrawatt.com)