

# **METRAHIT | ULTRA and METRAHIT | ULTRA BT**

High Resolution TRMS Digital Multimeter

3-349-684-03  
9/5.17



## Scope of Delivery

- 1 Multimeter
- 1 KS17-2 measurement cable set
- 2 Batteries
- 1 DAkkS calibration certificate
- 1 Rubber holster
- 1 Condensed operating instructions \*

\* Detailed operating instructions are available for download on the Internet at [www.gossenmetrawatt.com](http://www.gossenmetrawatt.com)

## Included Functions

Function	METRAHIT ULTRA / METRAHIT ULTRA BT
	M248A / M248B
Voltage, $V_{DC}$ ( $R_i = 10\text{ M}\Omega$ )	✓
Voltage, $V_{AC}$ TRMS ( $R_i = 5\text{ M}\Omega$ )	✓
Voltage, $V_{AC+DC}$ TRMS ( $R_i \geq 5\text{ M}\Omega$ )	✓
Frequency, Hz @ $V_{AC}$ @ $V_{AC+DC}$	Up to 300 kHz
1 kHz low-pass filter	@ $V_{AC}$ @ $V_{AC+DC}$
Bandwidth @ $V_{AC+DC}$ or $V_{AC}$	100 kHz
Pulse frequency, MHz @ 5 V TTL	1 Hz to 1 MHz
Duty cycle as %	2.0% to 98%
Voltage level measurement, dB	@ $V_{AC}$ @ $V_{AC+DC}$
Resistance, $\Omega$	✓
Continuity test, I <sub>CONST</sub> = 1 mA	✓
Diode test, I <sub>CONST</sub> = 1 mA	✓
Temp. measurement °C/°F @ $T_C$	Type K
Temp. measurement °C/°F $R_{TD}$	Pt100/Pt1000
Capacitance measurement, F	✓

Function	METRAHIT ULTRA / METRAHIT ULTRA BT
	M248A / M248B
Current, $A_{DC}$	300 $\mu$ A / 3 mA
Current, $A_{AC+DC}$ TRMS	30 mA / 300 mA
Current, $A_{AC}$ TRMS	3 A / 10 A (16 A)
Bandwidth @ $A_{AC+DC}$ or $A_{AC}$	10 kHz
Frequency, Hz @ $A_{AC}$ @ $V_{AC+DC}$	Up to 30 kHz
Current clamp measurement with adjustable transformation ratio	$\infty$ mV / A $\infty$ mA / A
Data logger function <sup>1</sup> (memory)	16 MBit (2 MB)
Relative value measurement $\Delta$ REL	✓
Zero point	✓
Min / Max / Data Hold	✓
IR interface (38.4 kBd)	✓
Bluetooth interface (38.4 kBd)	M248B only
Power pack socket	✓
Rubber holster	✓
Fuse	10 A / 1000 V
Protection	IP 52
Measuring category	600 V CAT III 300 V CAT IV
DAkkS Calibration Certificate	✓

<sup>1</sup> 16 Mbit = 2048 kByte = 300,000 measured values, sampling rate adjustable from 0.1 seconds to 9 hours

### **Accessories (sensors, plug inserts, adapters, consumable materials)**

The accessories available for your instrument are checked for compliance with currently valid safety regulations at regular intervals, and are amended as required for new applications. Currently up-to-date accessories which are suitable for your measuring instrument are listed at the following web address along with photo, order number, description and, depending upon the scope of the respective accessory, data sheet and operating instructions: [www.gossenmetrawatt.com](http://www.gossenmetrawatt.com)

See also section 10 on page 70.

### **Product Support**

Technical Queries  
(use, operation, software registration)

If required please contact:

GMC-I Messtechnik GmbH

#### **Product Support Hotline**

Phone: +49 911 8602-0

Fax: +49 911 8602-709

e-mail: [support@gossenmetrawatt.com](mailto:support@gossenmetrawatt.com)

### **Software Enabling for METRAWin10** (as of version 6.xx)

GMC-I Messtechnik GmbH

#### **Front Office**

Phone: +49 911 8602-111

Fax: +49 911 8602-777

e-mail: [info@gossenmetrawatt.com](mailto:info@gossenmetrawatt.com)

**Recalibration Service**

Our service center **calibrates** and **recalibrates** all instruments supplied by GMC-I Messtechnik GmbH, as well as other manufacturers, (for example after one year as part of your test equipment monitoring system, and prior to use etc.) and offers free test equipment management.

**Repair and Replacement Parts Service  
Calibration Center\* and Rental Instrument Service**

If required please contact:

GMC-I Service GmbH  
**Service Center**  
Thomas-Mann-Str. 20  
90471 Nürnberg, Germany  
Phone: +49 911 817718-0  
Fax: +49 911 817718-253  
e-mail: [service@gossenmetrawatt.com](mailto:service@gossenmetrawatt.com)  
[www.gmci-service.com](http://www.gmci-service.com)

This address is only valid in Germany. Please contact our representatives or subsidiaries for service in other countries.

\* **DAkkS calibration laboratory for measured electrical quantities,  
D-K-15080-01-01, accredited in accordance with DIN EN ISO/IEC 17025**

Accredited quantities: direct voltage, direct current value, direct current resistance, alternating voltage, alternating current value, AC active power, AC apparent power, DC power, capacitance, frequency, temperature

**Competent Partner**

GMC-I Messtechnik GmbH is certified in accordance with DIN EN ISO 9001.

Our DAkkS calibration laboratory is accredited by the Deutsche Akkreditierungsstelle GmbH (national accreditation body for the Federal Republic of Germany) under registration number D-K-15080-01-01 in accordance with DIN EN ISO/IEC 17025.

We offer a complete range of expertise in the field of metrology: from **test reports** and **factory calibration certificates** right on up to **DAkkS calibration certificates**.

Our spectrum of offerings is rounded out with free **test equipment management**.

As a full service calibration laboratory, we can calibrate instruments from other manufacturers as well.



## Table of Contents

Content	Page	Content	Page
<b>1 Safety Features and Precautions</b> .....	<b>8</b>	<b>5 Measurements</b> .....	<b>28</b>
1.1 Use for Intended Purpose .....	10	5.1 Voltage Measurement .....	28
1.2 Meanings of Danger Symbols .....	11	5.1.1 Direct and Pulsating Voltage Measurement, V DC and V (DC+AC) .....	29
1.3 Meanings of Acoustic Warning Signals .....	11	5.1.2 Alternating Voltage and Frequency Measurement V AC and Hz V AC with Selectable Low-Pass Filter, V AC + FiL and dB V AC .....	31
<b>2 Operating Overview – Connections, Keys, Rotary Switch, Symbols</b> .....	<b>12</b>	5.1.3 Frequency and Duty Cycle Measurement .....	34
<b>3 Initial Start-Up</b> .....	<b>16</b>	5.2 Resistance Measurement $\Omega$ .....	35
3.1 Inserting Batteries or Rechargeable Batteries .....	16	5.3 Continuity Test with Constant Current of 1 mA .....	36
3.2 Switching the Instrument On .....	16	5.4 Diode Testing with Constant Current of 1 mA .....	37
3.3 Setting the Operating Parameters .....	16	5.5 Temperature Measurement .....	38
3.4 Switching the Instrument Off .....	17	5.5.1 Measurement with Thermocouples, Temp TC .....	38
<b>4 Control Functions</b> .....	<b>18</b>	5.5.2 Measurement with Resistance Sensors .....	39
4.1 Selecting Measuring Functions and Measuring Ranges .....	18	5.6 Capacitance Measurement .....	40
4.1.1 Automatic Range Selection .....	18	5.7 Current Measurement .....	41
4.1.2 Manual Measuring Range Selection .....	19	5.7.1 Direct and Pulsating Current Measurement, Direct Connection, A DC and A (DC+AC) .....	42
4.1.3 Quick Measurements .....	20	5.7.2 Alternating Current and Frequency Measurement, Direct Connection, A AC and Hz .....	43
4.2 Zero Offset / Relative Measurements .....	20	5.7.3 Direct and Pulsating Current Measurement with Current Clamp Sensor, A DC and A (DC+AC) .....	44
4.3 Display (LCD) .....	21	5.7.4 Alternating Current Measurement with Current Clamp Sensor, A AC and Hz .....	45
4.4 Measured Value Storage: DATA (auto-hold / compare) .....	22	5.7.5 Alternating Current Measurement with Current Clamp Transformer, A AC and Hz .....	46
4.4.1 Saving Minimum and Maximum Values – Min/Max Function .....	23		
4.5 Measurement Data Recording .....	24		
4.5.1 Long-Term Recording .....	24		
4.5.2 Storage of Individual Values using the SAMPLE or dAtA Sampling Rate .....	26		

Content	Page	Content	Page
<b>6 Device and Measuring Parameters .....</b>	<b>48</b>	<b>10 Accessories .....</b>	<b>70</b>
6.1 Paths to the Various Parameters .....	49	10.1 General .....	70
6.2 List of All Parameters .....	49	10.2 Technical Data for Measurement Cables (scope of delivery: KS17-2 safety cable set) .....	70
6.3 Querying Parameters – InFo Menu .....	50	10.3 NA X-TRA Power Pack (not included) .....	70
6.4 Entering Parameters – SETUP Menu .....	51	10.4 Interface Accessories (not included) .....	71
6.5 StorE Menu – Parameter for Memory Mode Operation .....	53	10.4.1 Infrared Interface .....	71
6.6 Default Settings .....	55	10.4.2 Bluetooth Interface .....	71
<b>7 Interface Operation .....</b>	<b>56</b>	<b>11 Index .....</b>	<b>72</b>
7.1 Activating the Interface .....	56		
7.2 Configuring Interface Parameters .....	57		
<b>8 Technical Data .....</b>	<b>58</b>		
<b>9 Maintenance and Calibration .....</b>	<b>66</b>		
9.1 Displays – Error Messages .....	66		
9.2 Batteries .....	66		
9.3 Fuse .....	67		
9.4 Housing Maintenance .....	68		
9.5 Return and Environmentally Sound Disposal .....	68		
9.6 Recalibration .....	69		
9.7 Manufacturer’s Guarantee .....	69		

### 1 Safety Features and Precautions

You have selected an instrument which provides you with high levels of safety.

This instrument fulfills the requirements of the applicable EU guidelines and national regulations. We confirm this with the CE mark. The relevant declaration of conformity can be obtained from GMC-I Messtechnik GmbH.

The TRMS digital multimeter has been manufactured and tested in accordance with the following safety regulations: IEC 61010-1:2010/DIN EN 61010-1:2011/VDE 0411-1:2011. When used for its intended purpose (see page 10), safety of the operator, as well as that of the instrument, is assured. Their safety is however not guaranteed, if the instrument is used improperly or handled carelessly.

**In order to maintain flawless technical safety conditions, and to assure safe use, it is imperative that you read the operating instructions thoroughly and carefully before placing your instrument into service, and that you follow all instructions contained therein.**

The multimeter is equipped with an **automatic socket blocking** mechanism for your safety, and in order to safeguard your instrument. This mechanism is linked to the rotary switch and only allows access to those jacks which are actually required for the selected function. It also prevents the user from turning the rotary switch to impermissible functions after the measurement cables have already been plugged in.

If dangerous voltages are applied in the high-impedance voltage measuring functions (switch position V), switching to low-impedance measuring functions (switch position  $\Omega$ , continuity, temperature or capacitance) causes "HiVoLt" to appear at the display and the respective measurement is disabled.

Hazardous touch voltages are not detected when the ohm or capacitance measurement is selected.

If the instrument switches itself off in the event that hazardous touch voltage is applied (only possible during memory mode operation), the high-voltage warning symbol remains visible at the display.

#### Measuring Categories and their Significance per IEC 61010-1

CAT	Definition
I	Measurements in electrical circuits which are not directly connected to the mains: <i>e.g. electrical systems in motor vehicles and aircraft, batteries etc.</i>
II	Measurements in electrical circuits which are electrically connected to the low-voltage mains: <i>via plug, e.g. in household, office and laboratory applications</i>
III	Measurements in building installations: Stationary consumers, distributor terminals, devices connected permanently to the distributor
IV	Measurements at power sources for low-voltage installations: meters, mains terminals, primary overvoltage protection devices

The measuring category and the maximum rated voltage which are printed on the device apply to your measuring instrument, for example 600 V CAT III.

Refer to section 10 regarding use of the measurement cables.

#### Observe the following safety precautions:

- The multimeter may not be used in **potentially explosive atmospheres** or in the vicinity of unprotected detonators or other explosive material.
- The **Bluetooth function** may not be activated on board of aircrafts according to the FCC or FAA guidelines as critical aircraft instruments might be disturbed.



- The multimeter may only be operated by persons who are capable of recognizing **touch hazards** and taking the appropriate safety precautions. Touch hazards according to the standard exist anywhere, where voltages of greater than 33 V TRMS or 70 V DC may occur. Avoid working alone when taking measurements which involve touch hazards. Be certain that a second person is present.
- **Maximum allowable voltage** between the voltage measuring sockets or all connector sockets and ground is 600 V for measuring category III and 300 V for measuring category IV.
- Be aware of the fact that dangerous voltage peaks with significant frequency components of greater than 1 kHz are not displayed when the **low-pass filter** is activated. We recommend measuring voltage without the low-pass filter first, in order to be able to detect any dangerous voltages.
- Be prepared for the occurrence of **unexpected voltages** at devices under test (e.g. defective devices). For example, capacitors may be dangerously charged.
- Make certain that the measurement cables are in flawless condition, e.g. no damage to insulation, no interruptions in cables or plugs etc.
- No measurements may be made with this instrument in electrical circuits with corona discharge (high-voltage).
- Special care is required when measurements are made in **HF electrical circuits**. Dangerous pulsating voltages may be present.
- Measurements under **moist ambient conditions** are not permitted.
- Be absolutely certain that the measuring ranges are not overloaded beyond their allowable capacities. Limit values are included in section 8, "Technical Data", in the table entitled "Measuring Functions and Measuring Ranges" in the "Overload Capacity" column.
- **The multimeter may only be operated with installed batteries or rechargeable batteries.** Dangerous currents and voltages are otherwise not indicated, and the instrument may be damaged.
- Observe visual and acoustic warning signals!
- The instrument may not be operated if the fuse cover or the battery compartment lid has been removed, or if its housing is open.
- The input for the current measuring range is equipped with a **fuse link**.  
Use specified fuses only (see page 63)! The fuse must have a **breaking capacity of at least 30 kA**.

## Safety Precautions

---

### Opening of Equipment / Repair

The equipment may be opened only by authorized service personnel to ensure the safe and correct operation of the equipment and to keep the warranty valid.

Even original spare parts may be installed only by authorized service personnel.

In case the equipment was opened by unauthorized personnel, no warranty regarding personal safety, measurement accuracy, conformity with applicable safety measures or any consequential damage is granted by the manufacturer.

### Repair and Parts Replacement by authorized service personnel

When the instrument is opened, voltage conducting parts may be exposed. The instrument must be disconnected from the measuring circuit before performing repairs or replacing parts. If repair of a live open instrument is required, it may only be carried out by trained personnel who are familiar with the dangers involved.

### Defects and Extraordinary Strains

If it may be assumed that the instrument can no longer be operated safely, it must be removed from service and secured against unintentional use.

Safe operation can no longer be relied upon:

- If the device demonstrates visible damage
- If the instrument no longer functions, or if malfunctioning occurs
- After long periods of storage under unfavorable conditions (e.g. humidity, dust or extreme temperature (see "Ambient Conditions" on page 64))

### 1.1 Use for Intended Purpose

- The multimeter is a portable device which can be held in the hand during the performance of measurements.
- Only those types of measurements described in section 5 may be performed with the measuring instrument.
- The measuring instrument, including measurement cables and plug-on test probes, may only be utilized up to the maximum specified measuring category (see page 63 and the table on page 8 regarding significance).  
If the measuring categories specified for the measuring instrument and the measurement cables differ from each other, the lower category applies to the application.
- Overload limits may not be exceeded. See technical data on page 58 for overload values and overload limits.
- Measurements may only be performed under the specified ambient conditions. See page 64 regarding operating temperature range and relative humidity.
- The measuring instrument may only be used in accordance with the specified degree of protection (IP code) (see page 64).

## 1.2 Meanings of Danger Symbols



Warning concerning a point of danger  
(attention, observe documentation!)



**Symbol on the LCD:**  
Warning concerning dangerous voltage at the measurement  
input:  $U > 45 \text{ V}$



### Note

The auto power off function (**APoFF** parameter) is deactivated when dangerous touch voltage is applied.

## 1.3 Meanings of Acoustic Warning Signals

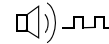

**Voltage warning:  $> 600 \text{ V}$  (intermittent acoustic signal)**

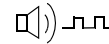

**Current warning:  $> 10 \text{ A}$  (intermittent acoustic signal)**

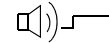

**Current warning:  $> 16 \text{ A}$  (continuous acoustic signal)**

## 2 Operating Overview – Connections, Keys, Rotary Switch, Symbols





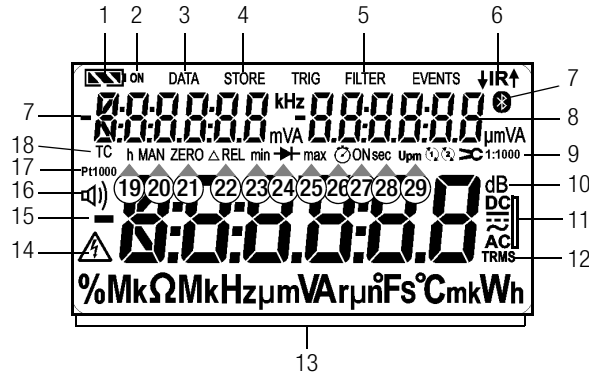

- 1 Display (LCD) (see page 14 for significance of symbols)
- 2 **MAN / AUTO** shift key for manual/automatic range selection  
 △ Increase parameter values  
*Operating mode menu:* select menu entries against flow direction
- 3 **ON / OFF | LIGHT**, on/off key for switching device and display light
- 4 **FUNC | ENTER** multifunction key  
*Operating mode menu:* acknowledge entry (ENTER)
- 5 ▷ Increase measuring range or move decimal point to right (MAN function)
- 6 **Rotary switch** for measuring functions, (see page 15 for significance of symbols)
- 7 DAKKS calibration seal
- 8 Connector socket for ground / connected to ground
- 9 Connector socket for current measurement with auto-blocking
- 10 Connector socket for voltage, resistance, temperature, diode and capacitance measurement with automatic blocking
- 11 **DATA / MIN / MAX**  
 Key for freezing, comparing and deleting the measured value, and for the Min-Max function  
 ▽ Decrease values  
*Operating mode menu:* select of menu entries in flow direction
- 12 **MEASURE | SETUP**  
 Key for switching between measuring and menu functions
- 13 **ZERO | ESC**  
 Key for zero balancing  
*Operating mode menu:* Exit current menu level and return to a higher level, exit parameters configuration without saving data
- 14 ◁ Decrease measuring range or move decimal to left (MAN function)
- 15 Power pack connector jack
- 16 Infrared interface



Symbols Used in the Digital Display





Battery Level Indicator

-  Battery full
-  Battery OK
-  Battery weak
-  Battery (almost) dead,  $U < 1.8\text{ V}$

Interface Indicator

-  Data transmission ↓ to / ↑ from multimeter active
-  IR interface in standby mode (ready to receive starting commands)

- 1 Battery level indicator
- 2 ON: continuous operation (automatic shutdown deactivated)
- 3 DATA: display memory, “freeze measured value”
- 4 STORE: memory mode active
- 5 FILTER: low-pass filter active
- 6 IR: infrared interface indicator
- 7 Bluetooth interface control display
- 8 **Auxiliary display:** digital display with decimal point and polarity display
- 9 Transformation ratio (factor for current sensor and transformer clamps)
- 10 dB: alternating voltage level measurement
- 11 Selected type of current
- 12 TRMS measurement
- 13 Unit of Measure
- 14 **Warning regarding dangerous voltage:  $U > 45\text{ V AC/DC}$**
- 15 **Main display:** digital display with decimal point and polarity display
- 16  Continuity test with acoustic signal active
- 17 Pt100/Pt1000: selected platinum resistance sensor with automatic recognition of Pt100/Pt1000
- 18 TC: temperature measurement with type K thermocouple (NiCr-Ni)
- 19 h (hours): unit of time
- 20 MAN: manual measuring range selection active
- 21 ZERO: zero balancing active
- 22 ΔREL: relative measurement with reference to offset
- 23 min: minimum value storage
- 24 Diode measurement selected
- 25 max: maximum value storage
- 26  Stopwatch active or time since beginning of measurement
- 27 ON: no function here
- 28 sec (seconds): unit of time
- 29 Upm : no function here

## Symbols Used for Rotary Switch Positions

Switch	FUNC	Main Display	Auxiliary Display	Measuring Function
V~	0/4	V~ AC TRMS	Hz	Alternating voltage, AC TRMS, full bandwidth / voltage frequency
Hz (V)	1	Hz	V~ AC	Voltage frequency, up to 300 kHz / alternating voltage, AC TRMS
V~ 1kHz	2	V FILTER ~ AC TRMS	Hz	Alternating voltage, AC TRMS, with low pass filter (1 kHz) / voltage frequency
dB	3	dB	V~ AC TRMS	Alternating voltage level measurement
V $\overline{\approx}$	0/4	V $\overline{\approx}$ DC + AC TRMS	Hz	Pulsating voltage, TRMS ( $V_{AC+DC} = \sqrt{V_{AC}^2 + V_{DC}^2}$ ) / voltage frequency
V $\overline{\approx}$	1	Hz	V $\overline{\approx}$ DC + AC TRMS	Voltage frequency / pulsating voltage, TRMS
V $\overline{\approx}$	2	V $\overline{\approx}$ FILTER DC + AC TRMS	Hz	Pulsating voltage, TRMS with low pass filter (1 kHz) / voltage frequency
dB	3	dB	V $\overline{\approx}$ DC + AC TRMS	Alternating voltage level measurement
V==	0/2	V== DC	—	Direct voltage
MHz	0/2	MHz	—	(High) frequency at 5 V~ up to 1 MHz
%	1	%	Hz	Duty cycle / frequency
$\Omega$	—	$\Omega$	—	(DC) resistance
$\square \downarrow$	0/2	$\square \downarrow$ $\Omega$	—	Continuity test ( $\Omega$ ) with acoustic signal
$\rightarrow \dashv$	1	$\rightarrow \dashv$ V== DC	—	Diode voltage up to max. 4.5 V
Temp. TC	0/2	°C, type K	°C internal temp. at jacks	Temperature, type K thermocouple
Temp. RTD	1	°X, Pt100		Temperature with Pt100 / Pt1000 resistance sensor
$\text{—} \parallel$	—	nF	—	Capacitance
A==	0/3	A== DC	—	Direct current value
A $\overline{\approx}$	1	A $\overline{\approx}$ DC + AC TRMS	Hz	Pulsating current amperage, TRMS AC+DC / current frequency
A $\overline{\approx}$	2	Hz	A $\overline{\approx}$ DC + AC TRMS	Frequency / pulsating current amperage, TRMS AC DC
A~	0/2	A~ AC TRMS	Hz	Alternating current amperage, TRMS AC / current frequency
Hz (A)	1	Hz ~ AC	Hz ~ AC	Current frequency / alternating current amperage, TRMS AC
$\times$ A ==	0/3	A== DC $\times$	—	DC amperage with AC DC Current clamp sensor, 1 V:1/10/100/1000 A
$\times$ A $\overline{\approx}$	1	A $\overline{\approx}$ DC + AC TRMS $\times$	Hz	Pulsating current amperage, TRMS / current frequency with AC DC current clamp sensor, see above
$\times$ A $\overline{\approx}$	2	Hz	A $\overline{\approx}$ DC + AC TRMS $\times$	Current frequency / pulsating current amperage, TRMS, with AC DC current clamp sensor, see above
$\times$ A ~	0/2	A~ AC TRMS $\times$	Hz	Alternating current amperage, TRMS, with Current clamp sensor, see above
Hz ( $\times$ A)	1	Hz ~ AC $\times$	~ AC	Current frequency

### User Interface Symbols in the Following Sections

- ▷ ... ▷ Scroll through main menu
- ▽ ... ▽ Scroll through submenu
- ◁ ▷ Select decimal point
- △ ▽ Increase/decrease value
- b FE* Submenu/parameter (7-segment font)
- Info** Main menu (7-segment font, boldface)

### Symbols on the Device



Warning concerning a point of danger (attention, observe documentation!)



Ground

**CAT III / IV** Measuring category III or IV device, see also “Measuring Categories and their Significance per IEC 61010-1” on page 8



Continuous, doubled or reinforced insulation



EC mark of conformity



Position of the infrared interface, window on the top of the instrument



Position of the power pack adapter socket, see also section 3.1



Fuse for current measuring ranges, see section 9.3



This device may not be disposed of with the trash. Further information regarding the WEEE mark can be accessed on the Internet at [www.gossenmetrawatt.com](http://www.gossenmetrawatt.com) under the search term WEEE (see also section 9.5).

Calibration Seal (blue seal):

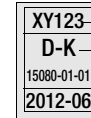

- Consecutive number
- Deutsche Akkreditierungsstelle GmbH – calibration lab
- Registration number
- Date of calibration (year – month)

See also “Recalibration” on page 69.

### 3 Initial Start-Up

#### 3.1 Inserting Batteries or Rechargeable Batteries

Be certain to refer to section 9.2 regarding correct battery installation.

Momentary battery voltage can be queried in the Info menu (see section 6.3).



#### Attention!

Disconnect the instrument from the measuring circuit before opening the battery compartment lid in order to replace the batteries.

---

#### Operation with the Power Pack

(accessory for METRAHIT ULTRA, not included, see section 10.3)

Installed batteries are disconnected electronically if the NA X-TRA power pack is used, and need not be removed from the instrument.

If rechargeable batteries are used, they must be recharged externally.

If the external power supply is switched off, the device is switched to battery operation without interruption.

#### 3.2 Switching the Instrument On

##### Switching the Instrument On Manually

- ⇨ Press the **ON / OFF | LIGHT** key until the display appears. Power-up is acknowledged with a brief acoustic signal. As long as the key is held depressed, all of the segments at the liquid crystal display (LCD) are illuminated. The LCD is depicted on page 13. The instrument is ready for use as soon as the key is released.

#### Display Illumination

After the instrument has been switched on, background illumination can be activated by briefly pressing the **ON / OFF | LIGHT** key. Illumination is switched back off by once again pressing the same key, or automatically after approximately 1 minute.

#### Switching the Instrument On with a PC

The multimeter is switched on after transmission of a data block from the PC, assuming that the “*r5Lb*” parameter has been set to “*r0n*” (see section 6.4).

**However, we recommend using the power saving mode: “*r0FF*”.**

---



#### Note

Electrical discharge and high frequency interference may cause incorrect displays to appear, and may disable the measuring sequence.

**Disconnect the device from the measuring circuit.** Switch the instrument off and back on again in order to reset. If the problem persists, briefly dislodge the battery from the connector contacts (see also section 9.2).

---

### 3.3 Setting the Operating Parameters

#### Setting Time and Date

See the “*t1PE*” and “*dALE*” parameter in section 6.4.



### 3.4 Switching the Instrument Off

#### Switching the Instrument Off Manually

⇨ Press the **ON / OFF | LIGHT** key until **OFF** appears at the display.

Shutdown is acknowledged with a brief acoustic signal.

*If hazardous contact voltage has been detected (HV symbol appears), the instrument cannot be switched off.*

#### Automatic Shutdown



The instrument is switched off automatically if the measured value remains unchanged for a long period of time (maximum measured value fluctuation of approx. 0.8% of the measuring range per minute or 1° C or 1° per minute), and if none of the keys or the rotary switch have been activated before a selected period of time in minutes has elapsed (see “*AP<sub>OFF</sub>*” parameter on page 51). Shutdown is acknowledged with a brief acoustic signal.

*Automatic shutdown is disabled in the following operating modes: continuous operation and whenever dangerous contact voltage has been detected (exception: memory mode).*

#### Disabling Automatic Shutdown

The instrument can be set to continuous operation.

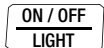
⇨ While switching the instrument on, simultaneously press the

 and  keys to this end.

The “Continuous On” function is indicated at by means of the **ON** display to the right of the battery symbol.

**The “Continuous On” setting can only be canceled by changing the respective parameter (see “*AP<sub>OFF</sub>*” page 51) or by switching the instrument off manually.**

**In this case, the parameter is reset to 10 minutes.**

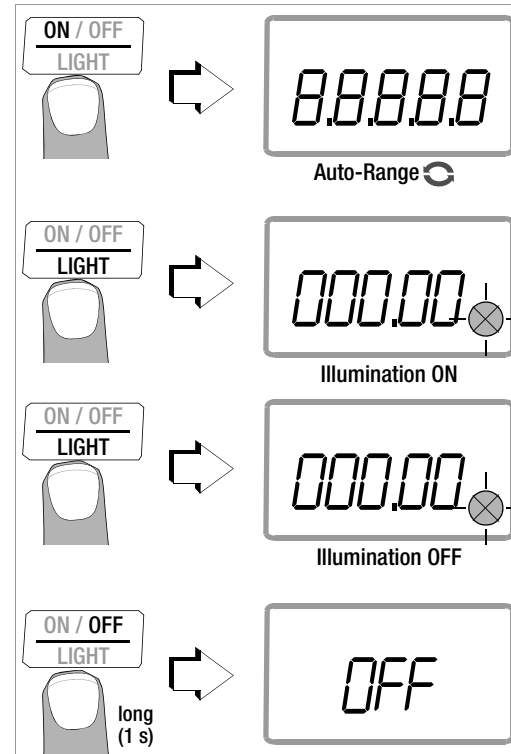

## 4 Control Functions

### 4.1 Selecting Measuring Functions and Measuring Ranges

The rotary switch is linked to the automatic socket blocking mechanism, which only allows access to two connector jacks for each function. Be certain to remove the appropriate plug from its respective jack before switching to and from the "A" functions. The socket blocking mechanism prevents the user from inadvertently turning the selector switch to impermissible functions after the measurement cables have been plugged into the instrument.

#### Presence of Dangerous Touch Voltages

If dangerous voltages are applied in the high-impedance voltage measuring functions (switch position V or PQ), switching to low-impedance measuring functions (switch position MHz,  $\Omega$ , continuity, temperature or capacitance) causes "HiVoLt" to appear at the display and the respective measurement is disabled. The measuring function is not switched until dangerous touch voltage is no longer applied to the input. If the instrument switches itself off in the event that hazardous touch voltage is applied (during memory mode operation with large

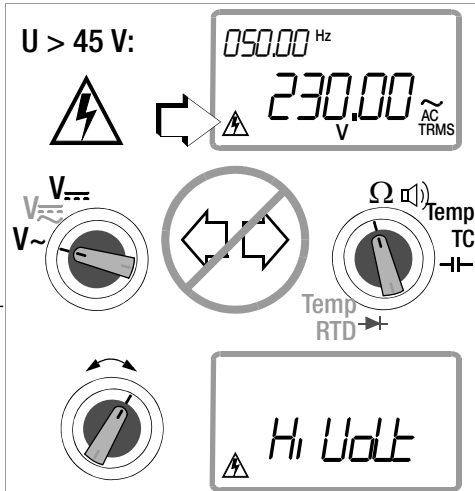

sampling period), the high-voltage warning symbol remains visible at the display.

#### 4.1.1 Automatic Range Selection

The multimeter is equipped with auto-ranging for all measuring functions, except for temperature measurement and diode and continuity testing. Auto-ranging is active as soon as the instrument is switched on. The instrument automatically selects the measuring range which allows for highest possible resolution of the applied quantity.

#### AUTO-Range Function

The instrument is switched automatically to the next higher range at  $\pm(310000 \text{ d} + 1 \text{ d}) \rightarrow 031,000$  digits, and to the next lower range at  $\pm(28000 \text{ d} - 1 \text{ d}) \rightarrow 27,999$  digits.

The instrument automatically switches to the next higher or next lower measuring range for the following measured quantities:

Measuring Range	Resolution	Switching to Next Higher Range at $\pm(\dots \text{ d} + 1 \text{ d})$	Switching to Next Lower Range at $\pm(\dots \text{ d} - 1 \text{ d})$
$V \sim$ , $A \sim$ , $\Omega$ , Hz	5%	310,000	28,000
$V \sim$ , $V \sim$ , $A \sim$ , $A \sim$	4%	31,000	2800
3 nF ... 3 mF	3%	3100	280

#### 4.1.2 Manual Measuring Range Selection

Auto-ranging can be deactivated and measuring ranges can be selected manually in accordance with the following table by pressing the **MAN / AUTO** button.

The desired measuring range can then be selected with the ◀ or ▶ scroll key.

The instrument is automatically returned to automatic range selection when the **MAN / AUTO** key is pressed, the rotary switch is activated or the instrument is switched off and back on again.

##### Overview: Auto-Ranging and Manual Range Selection

	Function	Display
<b>MAN / AUTO</b>	Manual mode active: utilized measuring range is fixed	MAN
◀ or ▶	Range switching sequence for: <b>V:</b> 300 mV* ↔ 3V ↔ 30 V ↔ 300 V ↔ 600 V <b>Hz (V AC):</b> 300 Hz ↔ 3 kHz ↔ 30 kHz ↔ 300 kHz <b>MHz:</b> 300 Hz ↔ 3 kHz ↔ 30 kHz ↔ 300 kHz ↔ 1 MHz <b>Ω:</b> 300 Ω ↔ 3 kΩ ↔ 30 kΩ ↔ 300 kΩ ↔ 3 MΩ ↔ 30 MΩ <b>A:</b> 300 μA ↔ 3 mA ↔ 30 mA ↔ 300 mA ↔ 3A ↔ 10 A (16 A) <b>Hz (A AC):</b> 300 Hz ↔ 3 kHz ↔ 30 kHz <b>F:</b> 3 nF ↔ 30 nF ↔ 300 nF ↔ 3 μF ↔ 30 μF ↔ 300 μF ↔ ↔ 3 mF	MAN
<b>MAN / AUTO</b>	Return to automatic measuring range selection	—

\* Via manual measuring range selection only

### 4.1.3 Quick Measurements

Measurements performed using a suitable fixed measuring range are executed more quickly than those which utilize automatic range selection. Quick measurement is made possible with the following two functions:

- **Manual measuring range selection**, i.e. selection of the measuring range with the best resolution (see section 4.1.2)

or

- With the **DATA function** (see section 4.4). In this way, the appropriate measuring range is selected automatically after the first measurement, and the second measurement is executed more quickly.

The selected measuring range remains active for the subsequent series of measurements with these two functions.

### 4.2 Zero Offset / Relative Measurements

Zero offset or a reference value for relative measurements can be stored to memory depending upon deviation from the zero point:

Deviation from zero – With short-circuited measurement cables for V, $\Omega$ , A – With open input for capacitance unit of measure (F)	Display
0 to 200 digits	ZERO $\Delta$ REL
> 200 D to (150,000 digits) 50% of the measuring range	$\Delta$ REL

The relevant reference or correction value is deducted individually for the respective measuring function as an offset from all future measurements and remains in memory until deleted, or until the multimeter is switched off.

Zero balancing and reference value adjustment can be used for auto-ranging, as well as for manual measuring range selection.

#### Zero Balancing

- ⇒ Plug the measuring cables into the instrument and connect the free ends to each other, except for capacitance measurement in which case the ends of the cables are not connected to each other.
- ⇒ Briefly press the **ZERO | ESC** key.  
The instrument acknowledges zero balancing with an acoustic signal, and the “ZERO  $\Delta$ REL” symbol appears at the LCD. The value measured at the moment the key is pressed serves as a reference value.
- ⇒ Zero balancing can be cleared by once again pressing the **ZERO | ESC** key.

#### Note

As a result of TRMS measurement, the multimeter can display a residual value of 1 to 30 digits with short-circuited measurement cables as the zero point for V AC / I AC or V(AC+DC) / I (AC+DC) measurements (non-linearity of the TRMS converter). This has no influence on specified accuracy of the measuring range.

#### Setting the Reference Value

- ⇒ Plug the measuring cables into the instrument and measure a reference value (max. 150,000 digits, in the 10 A DC range: 50,000 digits = 50% of the measuring range).

- ⇨ Briefly press the **ZERO | ESC** key.  
The instrument acknowledges storage of the reference value with an acoustic signal, and the “ZERO ΔREL” or the “ΔREL” symbol appears at the LCD. The value measured at the moment the key is pressed serves as a reference value.
- ⇨ The reference value can be cleared by once again pressing the **ZERO | ESC** key.

#### **Notes Regarding Relative Measurement**

- Relative measurement effects the main display only.
- In the case of relative measurement,  $\Omega$  F or AC quantities may also appear as negative values.

### **4.3 Display (LCD)**

#### **Measured Value, Unit of Measure, Type of Current, Polarity**

The measured value with decimal and plus or minus sign appears at the digital display. The selected unit of measure and current type are displayed as well. A minus sign appears to the left of the value during the measurement of zero-frequency quantities, if the plus pole of the measured quantity is applied to the “ $\perp$ ” input.

#### **Overranging**

If the upper range limit of 31,000 digits is exceeded “ $\overline{OL}$ ” (overload) appears at the display.  
“ $\overline{OL}$ ” appears at the display as of 3100 digits during capacitance measurement, as well as during continuity and diode testing.

## 4.4 Measured Value Storage: DATA (auto-hold / compare)

An individual measured value can be automatically “frozen” with the DATA function (auto-hold). This is useful, for example, when contacting the measuring points with the test probes requires your full attention. After the measuring signal has been applied and the measured value has settled in accordance with the “condition” listed in the table below, the measured value is frozen at the digital display and an acoustic signal is generated. The test probes can now be removed from the measuring points, and the measured value can be read from the digital display. If the measuring signal falls below the value specified in the table, the function is reactivated for storage of the next value.

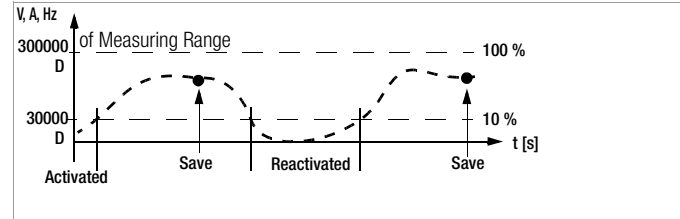

### Measured Value Comparison (DATA compare)

If the currently frozen value deviates from the first saved value by less than 100 digits, the acoustic signal is generated twice. If deviation is greater than 100 digits, only a brief acoustic signal is generated.

#### Note

The selected measuring range cannot be manually changed as long as the DATA function is active.

The DATA function is deactivated by pressing and holding the **DATA/MIN/MAX** key (approx. 1 second), when the measuring function is changed or when the instrument is switched off and back on again.

DATA Function	Press DATA / Min-Max	Condition		Response from Instrument		
		Measuring Function	Measuring Signal	Display	MV Digital	Acoustic
Activate	Brief				Blinks	Once
Save (stabilized measured value)		V, A, Hz, dB, F, %	> 10% r MR	Is displayed	Static	Once Twice <sup>2</sup>
		$\Omega$ (1)	$\neq \Delta L$			
Reactivate <sup>1)</sup>		V, A, Hz, dB, F, %	< 10% r MR	Stored MV	Blinks	
		$\Omega$ (1)	$= \Delta L$			
Change to Min-Max	Brief	See table in section 4.4.1				
Exit	Long			Is cleared	Is cleared	Twice

<sup>1</sup> Reactivation results from falling short of specified measured value limits.

<sup>2</sup> Two acoustic signals are generated the first time a measured value is saved as a reference value. For subsequent data hold, two acoustic signals are only generated if the currently frozen value deviates from the **first saved value by less than 100 digits**.

Key: MV = measured value, MR = measuring range

### Example

The voltage measuring range is set manually to 3 V. The first measured value is 2.2 V and is stored to memory because it is greater than 5000 digits of the measuring range (= 0.3 V), and is thus reliably above the background noise level. As soon as the measured value drops to less than 3000 digits of the measuring range, i.e. amounts to less than 0.3 V which corresponds to removal of the test probes from the measuring point, the instrument is ready to store a new value.

#### 4.4.1 Saving Minimum and Maximum Values – Min/Max Function

Minimum and maximum measured values applied to the measuring instrument's input after the Min-Max function has been activated can be "frozen" at the display. The most important use of this function is the determination of minimum and maximum values during long-term measured value observation.

The Min=Max function can be activated in all measuring functions. Apply the measured quantity to the instrument and set the measuring range with the **MAN / AUTO** key before activating the Min-Max function.

The Min-Max function is deactivated by pressing and holding the **DATA/MIN/MAX** key (approx. 1 second), when the measuring function is changed or when the instrument is switched off and back on again.



#### Note

As opposed to the DATA function, the Min-Max function can also be used for temperature measurement.

Function Min-Max	Press DATA / Min-Max	Min. and Max. Measured Values	Response from Instrument		
			Display Measured value, digital	Max. min.	Acous- tic Signal
1 Activate and save m	2 x short	are saved	Current measured value	Max and min	2 x
2 Save and display	Brief	Storage continues in background, new min. and max. values are displayed.	Saved min. value	Min.	1 x
	Brief		Saved max. value	max.	1 x
3 Return to 1	Brief	Same as 1, stored values are not deleted	Same as 1	Same as 1	1 x
Stop	Long	are deleted	Current measured Vvalue	is deleted	2 x

### 4.5 Measurement Data Recording

The instrument is capable of recording measurement data using an adjustable sampling rate for long periods of time in the form of measurement series. Data are stored to permanent memory, and are retained even after the multimeter is switched off, and after battery replacement. The system acquires measured values relative to real-time.

Stored measured values can subsequently be read out at the computer. The only prerequisite is a PC which is connected by means of an interface cable to the USB X-TRA bidirectional interface adapter, which is plugged onto the **METRAHIT ULTRA**. See also section 7, "Interface Operation".

#### 4.5.1 Long-Term Recording

##### Preparing for Recording – Parameter Settings

- First set the **sampling rate** for memory mode operation (see *rATE* parameter on page 53).
- Set **hysteresis** for efficient use of available memory space. During memory mode operation, new measured data are only saved if they deviate from the previously stored value by an amount which exceeds the selected hysteresis value (see "*HYSL*" parameter on page 53).
- Adjust "*t.StorE*" (see page 54) in order to limit recording duration.
- First select the desired measuring function and an appropriate measuring range.
- Check the battery charge level before starting long-term measurement recordings (see section 9.2). Connect the NA X-TRA power pack if required.

### Memory Parameters Overview

Parameter	Page: header
<i>CLEAR</i>	25: Clear Memory
<i>ENPLY</i>	25: Clear Memory – appears after <i>CLEAR</i>
<i>HYSL</i>	53: HYSL – Hysteresis (parameter for memory mode operation)
<i>OCCUP</i>	25: Querying Memory Occupancy
<i>rATE</i>	53: rATE – Set Transmission and Storage Rate
<i>StArT</i>	24: Starting Recording via Menu Functions
<i>StoP</i>	25: Ending Recording
<i>trIG</i>	54: triG – Trigger Conditions (parameters for memory mode operation)
<i>tStorE</i>	54: tStorE – Recording Time (parameter for memory mode operation)

#### Starting Recording via Menu Functions

- Switch to the "*SEtUP*" mode by pressing **MEASURE | SETUP** and select the "*StorE*" menu.



- Memory mode operation is started by acknowledging with **FUNC | ENTER**. **STORE** appears in the header and indicates that the memory mode has been activated. "*StorE*" appears at the main display. If trigger conditions are activated, **TRIG** also blinks in the header.
- Press the **MEASURE | SETUP** key in order to return to the measuring function.



### Ending Recording

- ⇨ If the instrument is in the measuring mode, return to the menu function by pressing the **MEASURE | SETUP** key. Select “**StorE**” again and acknowledge by pressing the **FUNC | ENTER** key. “**StorE**” blinks at the main display.



*StorE* on **StorE**  *StorE*

- ⇨ Acknowledge the “**StorE**” display by pressing **FUNC | ENTER**. The **STORE** display segment in the header is cleared, indicating that recording has been ended.
- ⇨ Press the **MEASURE | SETUP** key in order to return to the measuring function.
- ⇨ Memory mode operation can also be exited by switching the multimeter off.

### Querying Memory Occupancy

Memory occupancy can be queried during recording with the help of the “**Info**” menu (see also section 6.3).

Memory occupancy range: 000.1% to 099.9%.

 **Info**  *bAtt* ▾ ▾ *OCCUP %* 0 17.4 %

### Clear Memory

This function deletes all measured values from memory!

It's advisable to execute this function before starting a new measurement data recording.

 **Info** ▷ ... ▷ *StorE*  *StorE* off **Start** (blinks)

▾ *StorE CLEAR*  *StorE CLEAR* no ▷ **YES** 

*StorE EMPTY* (appears briefly) → *StorE*

### 4.5.2 Storage of Individual Values using the **SAMPLE** or **dAtA** Sampling Rate

If only individually selected values need to be saved, **SAMPLE** must be selected as the StorE > rAtE sampling value. If memory mode operation is then started, a single measured value is saved to permanent memory with time stamp when the **DATA/MIN/MAX** key is pressed and held until two rapidly repeating acoustic signals are generated.

If **dAtA** is selected as the StorE > rAtE sampling rate, and if memory mode operation is then started, measured values ascertained with activated DATA function are automatically saved to permanent memory with time stamp.



## 5 Measurements

### 5.1 Voltage Measurement

#### Notes Regarding Voltage Measurement

- **The multimeter may only be operated with installed batteries or rechargeable batteries.** Dangerous voltages are otherwise not indicated, and the instrument may be damaged.
- The multimeter may only be operated by persons who are capable of recognizing **contact hazards** and taking the appropriate safety precautions. Contact hazards exist anywhere, where voltages of greater than 33 V (RMS) may occur. The test probes may only be gripped up to the finger guard. Do not touch the metallic test probes under any circumstances.
- Avoid working alone when taking measurements which involve **touch hazards**. Be certain that a second person is present.
- **For the METRAHIT ULTRA, maximum allowable voltage** between the connector sockets and ground is 600 V for measuring category III and 300 V for measuring category IV.
- Be prepared for the occurrence of unexpected voltages at devices under test (e.g. defective devices). For example, capacitors may be dangerously charged.
- No measurements may be made with this instrument in electrical circuits with corona discharge (high-voltage).
- Special care is required when measurements are made in HF electrical circuits. Dangerous pulsating voltages may be present.
- **Be aware of the fact that dangerous voltage spikes are not displayed during measurement with the low-pass filter. We recommend measuring voltage without the low-pass filter first, in order to be able to detect any dangerous voltages.**

- Be absolutely certain that the **measuring ranges are not overloaded beyond their allowable capacities**. Limit values are included in section 8, “Technical Data”, in the table entitled “Measuring Functions and Measuring Ranges” in the “Overload Capacity” column.
- **300 mV range:** Thermovoltages occur in the event of temperature fluctuation, which appear as additional voltage offset. It may be necessary to repeat zero offsetting in order to achieve the specified degree of accuracy.

#### Scope of Functions, Voltage Measurement

Function	METRAHIT ULTRA
V AC / Hz TRMS, dB (Ri = 5 MΩ) <sup>1</sup>	•
V AC / TP-Filter 1 kHz <sup>1</sup> (Ri = 5 MΩ) TRMS	•
V AC+DC TRMS / TP-Filter (Ri =5 MΩ)	•
V DC (Ri = 10 MΩ)	•
Pulse frequency, MHz @ 5 V TTL	•
Duty cycle as %	•
Voltage level measurement, dB	@ V <sub>AC</sub> @ V <sub>AC+DC</sub>
Frequency bandwidth	100 kHz

<sup>1</sup> A 1 kHz low-pass filter can be used in this case, in order to filter out high frequency pulses of greater than 1 kHz, for example when performing measurements at pulsed motor drives.

5.1.1 Direct and Pulsating Voltage Measurement, V DC and V (DC+AC)



**Note**

Set the  $CL, P$  parameter to **OFF** in the current clamp setup menu. Otherwise all measured values are displayed in amperes, corrected by the amount resulting from the selected transformation ratio for an interconnected current clamp sensor.



- In accordance with the voltage to be measured, turn the rotary switch to  $V_{DC}$  or  $V_{AC}$ .
- Connect the measurement cables as shown. The “⊥” connector jack should be grounded.



**Note**

An intermittent acoustic signal warns the operator if the measured value exceeds the upper range limit in the 600 V range.

Make sure that a current measuring range (“A”) has not been activated when the multimeter is connected for voltage measurement! If the fuse’s blowing limits are exceeded as a result of operator error, both the operator and the instrument are in danger!

With the rotary switch in the V position, the multimeter is always in the 3 V measuring range immediately after it is switched on. As soon as the **MAN / AUTO** key is pressed, and assuming the measured value is less than 300 mV, the multimeter is switched to the mV measuring range.

$CL, P = OFF!$

$CL, P = OFF!$

1kHz  
dB

$V_{DC}$

Hz  
 $V_{AC TRMS}$

- (+)  
+ (-)

**Measuring Ranges:**

$V_{DC}$  : 300 mV...600 V

$V_{AC TRMS}$  : 300 mV...600 V

Hz: 5 Hz ... 300 kHz

Max. 600 V (< 5 kHz)

Max. 100 V (> 10 kHz)

$P_{max} = 3 \times 10^6 \text{ V} \times \text{Hz}$   
for  $U > 100 \text{ V}$

**Warnings regarding dangerous voltage:**

> 45 V:

> 600 V:

## Frequency Measurement in the V (DC+AC) Switch Position

- Connect the measured quantity in the same way as for voltage measurement.
  - Manually select the measuring range for the voltage amplitude.
  - Repeatedly press the multifunction key **FUNC** | **ENTER** until the unit of measure Hz appears at the display.
- Lowest measurable frequencies and maximum allowable voltages are listed in section 8, "Technical Data".

## Measurement with Low-Pass Filter

### ! Attention!

Be aware of the fact that dangerous voltage spikes are not displayed during this type of measurement (see also "Voltage Comparator"). We recommend measuring voltage without the low-pass filter first, in order to be able to detect any dangerous voltages.

A 1 kHz low-pass filter can be activate if required, in order to filter out high frequency pulses of greater than 1 kHz, for example when performing measurements at pulsed motor drives, i.e. undesired voltages of greater than 1 kHz can be suppressed.

The active low-pass filter is indicated by the **FILTER** display. The multimeter is automatically switched to manual measuring range selection.

Specified measuring accuracy is not reached with signals of greater than 100 Hz when the filter is active.

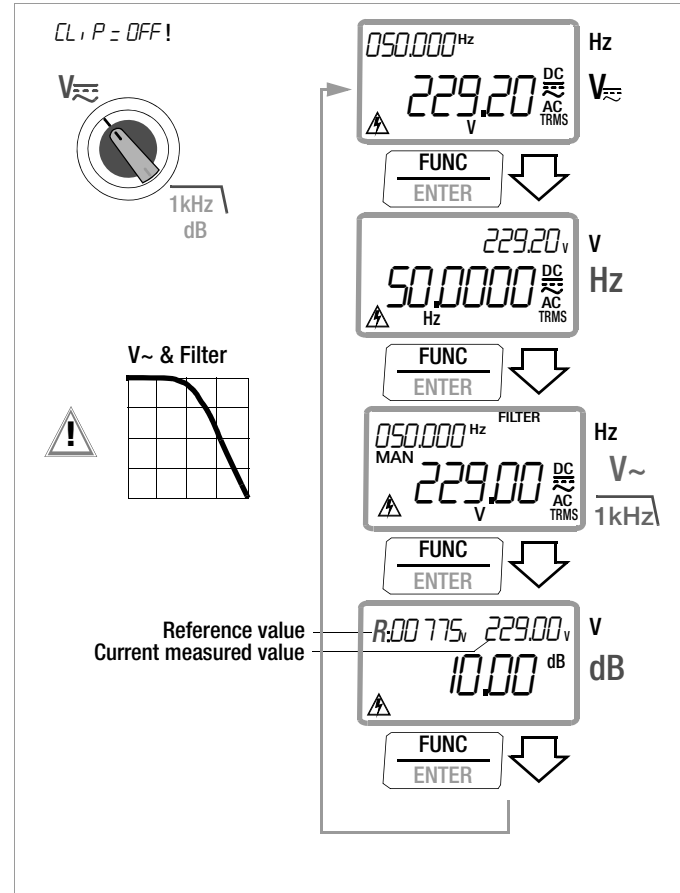

### 5.1.2 Alternating Voltage and Frequency Measurement V AC and Hz V AC with Selectable Low-Pass Filter, V AC + Fil and dB V AC



#### Note

See note in section 5.1.1.

- ⇨ In accordance with the voltage or frequency to be measured, turn the rotary switch to V~.
- ⇨ Connect the measurement cables as shown. The “⊥” connector jack should be grounded.

#### Voltage Measurement



#### Note

An intermittent acoustic signal warns the operator if the measured value exceeds the upper range limit in the 600 V range.

Make sure that a current measuring range (“A”) has not been activated when the multimeter is connected for voltage measurement! If the fuse’s blowing limits are exceeded as a result of operator error, both the operator and the instrument are in danger!

- ⇨ You can switch back and forth between voltage measurement with and without low-pass filter.
- ⇨ Repeatedly press the multifunction key **FUNC | ENTER** until unit of measure V in appears at the main display, and **FILTER** appears in the header for measurement with low-pass filter.

#### Frequency Measurement

- ⇨ Connect the measured quantity in the same way as for voltage measurement.
- ⇨ Manually select the measuring range for the voltage amplitude.
- ⇨ Repeatedly press the multifunction key **FUNC | ENTER** until unit of measure Hz appears at the display. Lowest measurable frequencies and maximum allowable voltages are listed in section 8, “Technical Data”.



#### Note

**Measurements performed close to the trigger level** may result in an incorrect display. If this is the case, select a smaller voltage measuring range.

In the case of measured values which are much higher than the expected results, the input signal may be distorted. Perform measurement with activated 1 kHz low-pass filter in this case.

#### Measurement with Low-Pass Filter



#### Attention!

Be aware of the fact that dangerous voltage spikes are not displayed during this type of measurement (see also “Voltage Comparator”. We recommend measuring voltage without the low-pass filter first, in order to be able to detect any dangerous voltages.

A 1 kHz low-pass filter can be activate if required, in order to filter out high frequency pulses of greater than 1 kHz, for example when performing measurements at pulsed motor drives, i.e. undesired voltages of greater than 1 kHz can be suppressed.

## V/Hz, $\Omega$ , Temperature, $\rightarrow$ and A/Hz Measurements



The active low-pass filter is indicated by the FILTER display. The multimeter is automatically switched to manual measuring range selection.

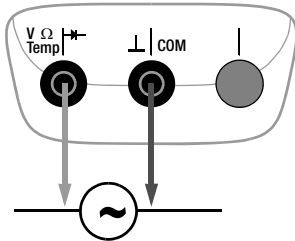

Specified measuring accuracy is not reached with signals of greater than 100 Hz when the filter is active.



**Measuring Ranges:**  
**V~:** 300 mV ... 600 V  
**Max. 600 V (< 5 kHz)**  
**Max. 100 V (> 10 kHz)**  
**Hz:** 5 Hz ... 300 kHz  
 $P_{max} = 3 \times 10^6 \text{ V} \times \text{Hz}$   
 for  $U > 100 \text{ V}$

**Warnings regarding dangerous voltage:**

> 45 V:  230.0 

> 600 V:  

### Voltage Comparator for Displaying Dangerous Voltage

The input signal or measuring signal is checked by a voltage comparator for dangerous spikes, because these do not appear at the display when the low-pass filter is used.

Where  $U > 45 \text{ V}$ , a danger symbol appears at the display. 

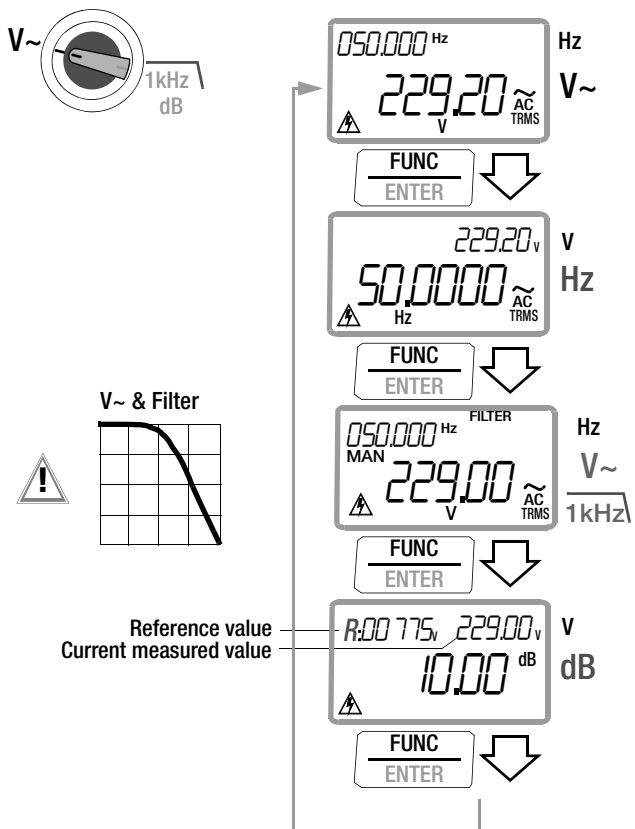

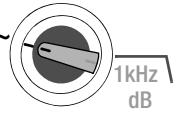
**V~** 

050.000 Hz  
 229.20 V AC TRMS

**FUNC**   
**ENTER**

229.20 V  
 50.0000 Hz AC TRMS

**FUNC**   
**ENTER**

050.000 Hz FILTER  
 MAN 229.00 V AC TRMS 1kHz

**FUNC**   
**ENTER**

Reference value: 10.00 dB  
 Current measured value: 229.00 V

**FUNC**   
**ENTER**

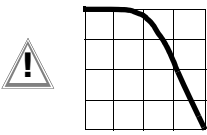
**V~ & Filter**  



**Alternating Voltage Level Measurement (dB)**

Voltage level measurement is used in order to ascertain overall attenuation or boosting of a transmission system (shown here as a 4-pole setup).

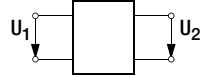

$$\text{VoltageLevel[dB]} = 20 \cdot \log \frac{U_2}{U_1}$$

Where  $U_1 = U_{\text{REF}}$  (reference level) = 0.775 V

Result > 1: boosting

Result < 1: attenuation

- ⇒ Manually select the measuring range for the voltage amplitude. When the instrument is switched to dB measurement, the previously selected voltage measuring range remains active.
- ⇒ Repeatedly press the multifunction key **FUNC | ENTER** until unit of measure dB appears at the display. Lowest measurable frequencies and maximum allowable voltages are listed in section 8, “Technical Data”.

The level measurement function is now activated. The measured value is calculated based upon the RMS value of the alternating voltage component relative to the measuring range (300 mV to 600 V), and displayed.

The default value for the reference level is 0 dB = 0.775 V (1 mW to 600 Ω). This value is a fixed setting and is displayed at the left-hand auxiliary display (R:00.775 v).

**Note**

No terminal resistors have been integrated into the device. It performs measurement with a high input impedance of 5 MΩ.

Input impedance for voltage measurement is listed under technical data.

In order to be able to perform correct measurement at non-terminated devices under test, the terminating resistor must be connected to the terminals. Be sure to take power loss at the terminating resistor into consideration!

## 5.1.3 Frequency and Duty Cycle Measurement

- ⇒ Set the rotary switch to MHz or %.
- ⇒ Connect the measurement cables as shown.

Make sure that a current measuring range (“A”) has not been activated when the multimeter is connected for frequency or duty cycle measurement!

**!** **Attention!**  
The applied signal voltage may not exceed 5 V.

### Frequency Measurement, MHz

A 5 V signal with a frequency of up to 1 MHz is measured and displayed using MHz as a unit of measure. The pulse frequency is the reciprocal value of the pulse period.

### Duty Cycle Measurement $t_E/t_P$

The ratio of pulse duration to pulse period is measured with periodic square-wave signals and is displayed as a percentage.

$$\text{Duty cycle (\%)} = \frac{\text{Pulse duration (} t_E \text{)}}{\text{Pulse period (} t_P \text{)}} \cdot 100$$

**Note**  
The applied frequency must remain constant during duty cycle measurement.

**MHz**

0.10323 kHz

**MHz**  
f<sub>p</sub>

**FUNC**  
ENTER

0.15000 Hz

002.00 %

**Hz**  
t<sub>E</sub>/t<sub>P</sub>

**Pulse Time Quantities**

- f<sub>p</sub> pulse frequency = 1/t<sub>p</sub>
- t<sub>E</sub> pulse duration
- t<sub>p</sub> pulse period
- t<sub>p</sub> - t<sub>E</sub> interpulse period
- t<sub>E</sub>/t<sub>p</sub> pulse or duty cycle

**Measuring Ranges:**  
f<sub>p</sub> pulse frequency range

Hz	t <sub>E</sub> /t <sub>P</sub>
15 Hz to 1 kHz	2 to 98%
Up to 10 kHz	5 to 95%

**v Ω Temp** **COM**

**Max. 5 V**

## 5.2 Resistance Measurement $\Omega$

- ⇨ Disconnect supply power from the electrical circuit of the device to be measured, and discharge all high-voltage capacitors.
- ⇨ Make sure that the device under test is voltage-free. Interference voltages distort measurement results! Refer to section 5.1.1 regarding testing for the absence of voltage with the help of the direct voltage measurement.
- ⇨ Set the rotary switch to " $\Omega$ ".
- ⇨ Connect the device under test as shown.



### Note

Use short or shielded measurement cables in the case of high-impedance resistance.

$\Omega$ : "OL" appears at the display in the case of an open connection.

### Improving Accuracy by means of Zero Balancing

Cable resistance and contact resistance can be eliminated in all measuring ranges by means of zero balancing (see section 4.2).

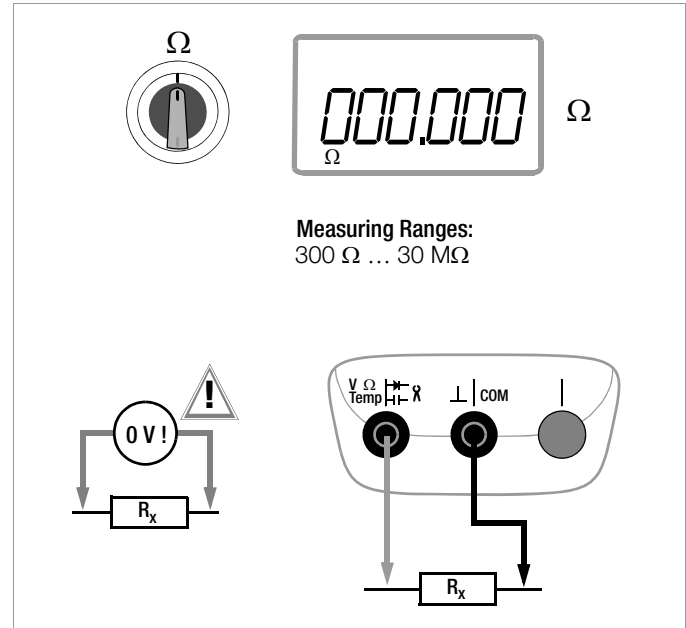

## 5.3 Continuity Test $\rightarrow$ ) with Constant Current of 1 mA

- Disconnect supply power from the electrical circuit of the device to be measured, and discharge all high-voltage capacitors.
  - Make sure that the device under test is voltage-free. Interference voltages distort measurement results!
  - Set the rotary switch to  $\rightarrow$ ).
  - Connect the conductor path under test as shown.
- “OL” appears at the display in the case of an open connection.  
Open circuit voltage is less than 4.5 V.

### Limit Value for Volume Resistance

Depending upon the selected limit value, the multimeter generates a continuous acoustic signal in the case of continuity or short-circuiting, i.e. at a value of less than the selected limit value. The limit value can be adjusted in the “**SEL**” menu (see also section 6.4):



(10 = default setting)

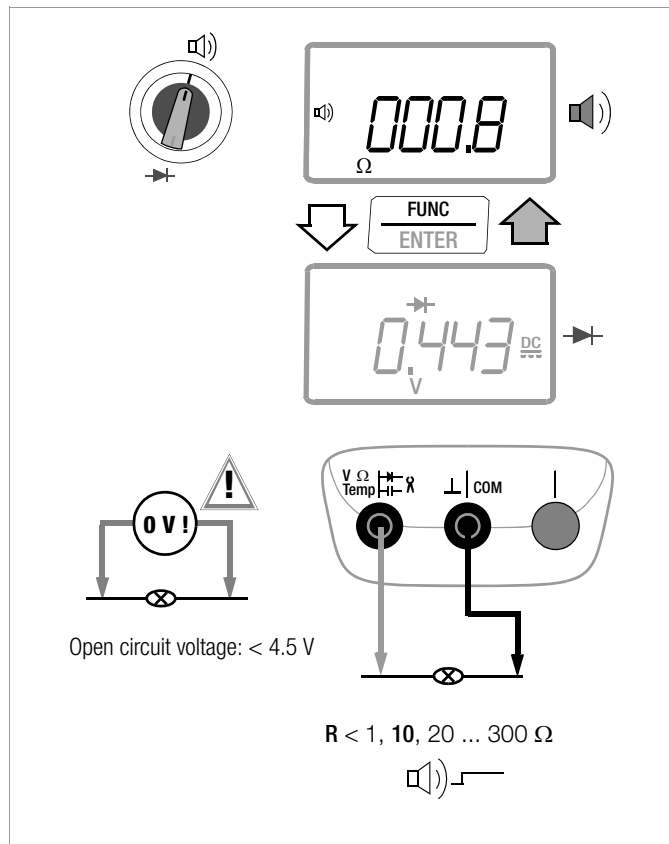

#### 5.4 Diode Testing $\rightarrow$ with Constant Current of 1 mA

- Disconnect supply power from the electrical circuit of the device to be measured, and discharge all high-voltage capacitors.
- Make sure that the device under test is voltage-free. Interference voltages distort measurement results!  
Refer to section 5.1.1 regarding testing for the absence of voltage with the help of the direct voltage measurement.
- Set the rotary switch to  $\rightarrow$ .
- Acknowledge by pressing the **FUNC | ENTER** key.
- Connect the device under test as shown.

##### Forward Direction and Short-Circuit

The instrument displays forward voltage in volts (display: 4 places). As long as voltage drop does not exceed the maximum display value of 4.5 V, several series connected components or reference diodes can be tested with a small reference voltage and Z-diodes.

##### Reverse Direction and Interruption

The measuring instrument indicates overload: "OL".

##### Note

Resistors and semiconductor paths connected in parallel to the diode distort measurement results!

##### Attention!

Observe high open-circuit voltage of 6 V during diode testing: Circuits must be laid out accordingly.

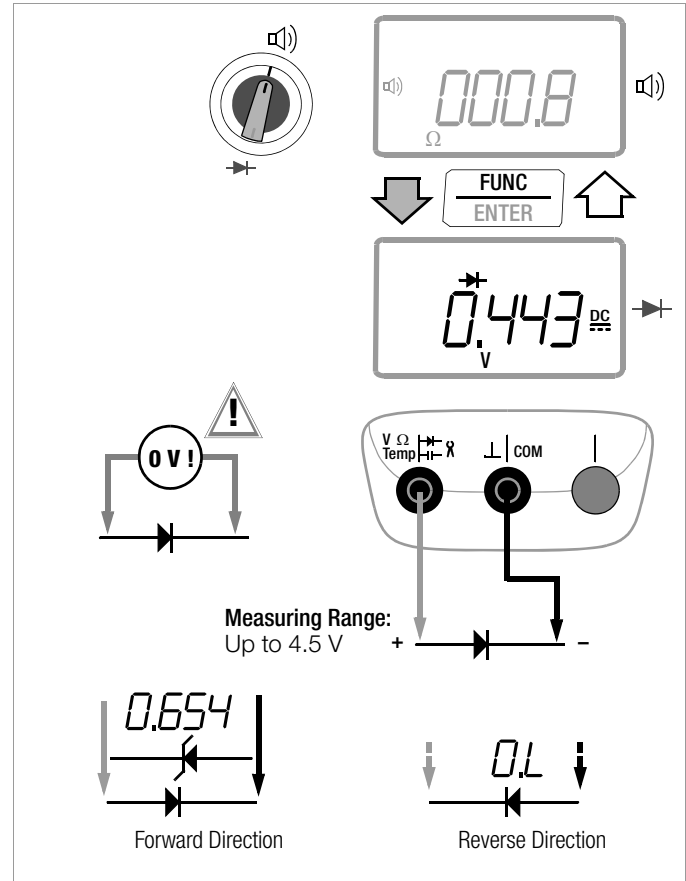

## 5.5 Temperature Measurement

Temperature measurement is performed with a type K thermocouple or a type Pt100 or Pt1000 resistance sensor (accessory, not included) which is connected to the voltage input.

Selecting the Unit of Measure for Temperature (°C = default value)

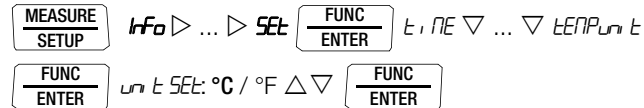

### 5.5.1 Measurement with Thermocouples, Temp TC

- ⇒ Set the rotary switch to “Temp<sub>TC</sub>”.

**Note**  
 The last selected temperature measurement or the last selected temperature sensor, i.e. type K or Pt100/Pt1000, remains in memory and is accordingly displayed. Press the **FUNC | ENTER** key in order to change to the other measuring function.

- ⇒ Either the internal reference junction (“iTEMP, rTEMP” parameter, see also page 52) or an external reference temperature can be specified as the reference temperature (see page 52). The type (“I.” for internal or “E.” for external) and temperature of the selected reference junction appears at the right-hand auxiliary display during measurement.

**Note**  
 The internal reference temperature (temperature of the internal reference junction) is measured by a temperature sensor inside of the instrument. This may deviate somewhat from room temperature as a result of internal heat-up, or moving from warmer to colder surroundings or vice versa.

- ⇒ Connect the sensor to the two accessible jacks. The instrument displays the measured temperature using the selected unit of measure.

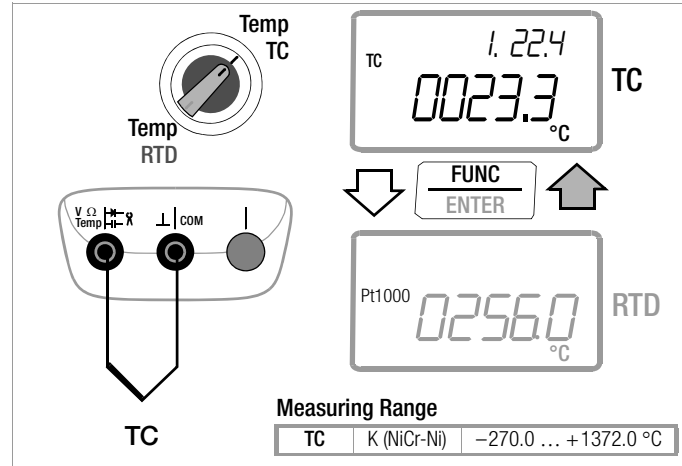

**Note**  
 After previously performing a 10 A current measurement, the measuring instrument should be allowed to cool down for 30 minutes before performing measurements with thermocouples, in order to assure that the specified accuracy levels are achieved.

### 5.5.2 Measurement with Resistance Sensors

- Set the rotary switch to “Temp<sub>TC</sub>” or “Temp<sub>RTD</sub>”.

The last selected temperature measurement or the last selected temperature sensor, i.e. type K or Pt100/Pt1000, remains in memory and is accordingly displayed. Press the **FUNC | ENTER** key in order to change to the other measuring function.

The sensor type, i.e. Pt100 or Pt1000, is detected automatically and displayed.

There are two different ways to compensate for cable resistance:

#### Automatic Compensation

- Acknowledge by pressing the **ZERO | ESC** key. “Short leads” appears at the display.

If you prefer to enter cable resistance directly, you can skip the following entry prompt.

- Short circuit the measuring instrument’s connector cables. “000.00” appears at the display. After pressing the **FUNC | ENTER** key, automatic compensation of cable resistance is activated for all subsequent measurements. The short-circuit can now be eliminated, and the device is ready for use.

#### Entering Cable Resistance

- Press the **ZERO | ESC** key once again in the automatic compensation menu.
- Enter the known resistance of the connector cables with the scroll keys: Select the digit to be changes with the  $\triangleleft \triangleright$  keys, and change the respectively selected digit with the  $\nabla \triangle$  keys. The default value is 0.43 Ω (Z3409). Values can be selected within a range of 0 to 50 Ω.

- Upon pressing the **FUNC | ENTER** key, the selected value is activated and the display is returned to the measuring function. Cable resistance remains in memory even after the instrument has been switched off.

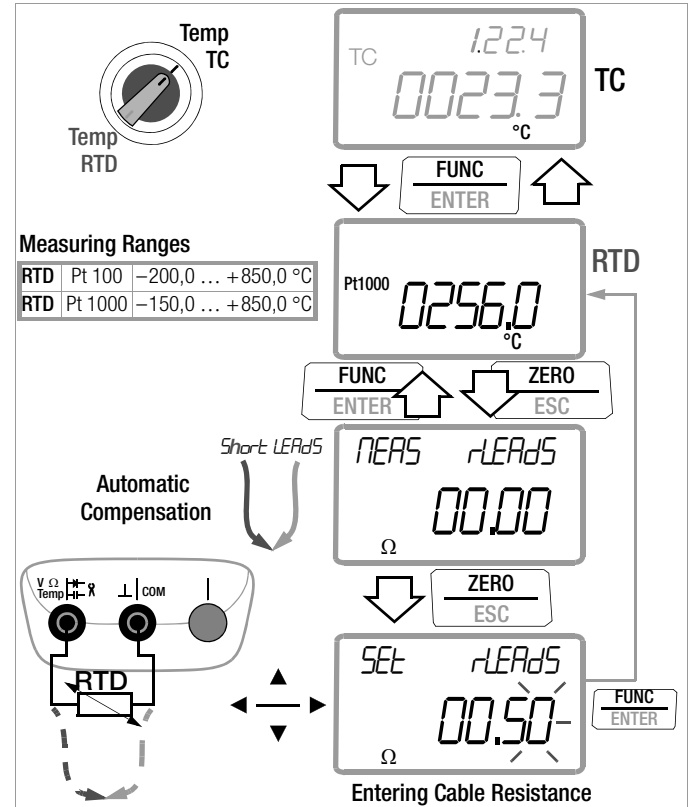

### 5.6 Capacitance Measurement $\overleftrightarrow{\text{}}$

- ⇨ Disconnect supply power from the electrical circuit of the device to be measured, and discharge all high-voltage capacitors.
- ⇨ Make sure that the device under test is voltage-free. Capacitors must always be discharged before measurement is performed. Interference voltages distort measurement results! Refer to section 5.1.1 regarding testing for the absence of voltage with the help of the direct voltage measurement.
- ⇨ Set the rotary switch to " $\overleftrightarrow{\text{}}$ ".
- ⇨ Connect the (discharged!) device under test to the sockets with the measurement cables as shown.

#### Note

The " $\perp$ " pole of polarized capacitors must be connected to the " $\perp$ " jack. Resistors and semiconductor paths connected in parallel to the capacitor distort measurement results!

#### Note

Use of the power pack may result in significant deviations during capacitance measurements!

#### Note

This function is above all intended for the measurement of components. For telecommunication systems, it's advisable to use the special capacitance measurement for measurements in symmetrical copper cable networks with the **METRAHIT | T-COM PLUS** cable multimeter.

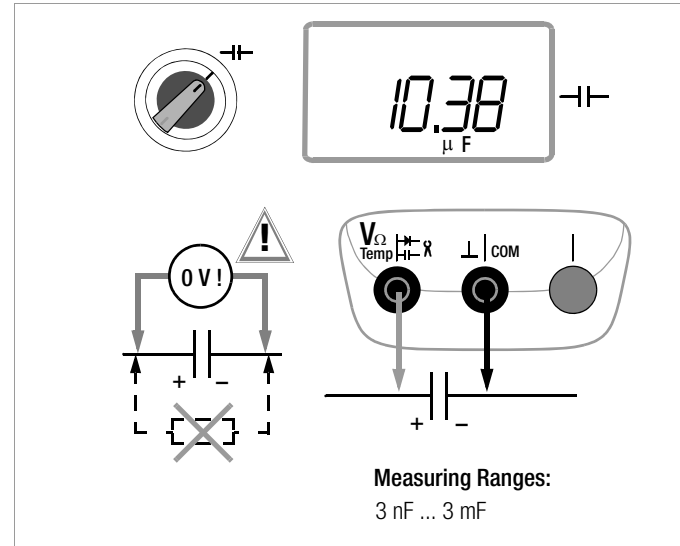



## 5.7 Current Measurement

### Notes Regarding Current Measurement

- **The multimeter may only be operated with installed batteries or rechargeable batteries. Dangerous currents are otherwise not indicated, and the instrument may be damaged.**
- Set up the measuring circuit in a mechanically secure fashion, and secure it against inadvertent breaks. Select conductor cross-sections and lay out connections such that they do not overheat.
- An intermittent acoustic signal warns of current greater than 10 A. A continuous acoustic signal warns of current greater than 16 A.
- When measuring high current values, limit them to max. 16 A for 30 seconds or 10 A for max. 5 minutes, and allow the multimeter to cool down for 10 minutes between measurements.
- For purposes of orientation, internal temperature in close proximity to the jacks is displayed at the right-hand auxiliary display in the 3 A and 10 A or 16 A ranges. If temperature rises to above 50° C, you are warned by an intermittent acoustic signal.
- The input for the current measuring range is equipped with a fuse link. Maximum permissible voltage for the measuring circuit (= rated voltage of the fuse) is 600 V AC/DC. Use specified fuses only! The fuse must have a **breaking capacity of at least 30 kA**.
- If the fuse for the active current measuring range blows, “*FUSE*” appears at the digital display, and an acoustic signal is generated at the same time.
- If a fuse should blow, eliminate the cause of overload before placing the instrument back into service!
- Fuse replacement is described in section 9.3.

- Be absolutely certain that the measuring ranges are not overloaded beyond their allowable capacities. Limit values are included in section 8, “Technical Data”, in the table entitled “Measuring Functions and Measuring Ranges” in the “Overload Capacity” column.

### \*Scope of Functions, Current Measurement, Direct Connection

Function	Switch Position	Measuring Range
Transformation ratio $\rightarrow$	SET menu, ClIP=OFF	
A DC $\rightarrow$	A $\rightarrow$	300 $\mu$ A 3 / 30 / 300 mA 3 / 10 A (16 A)
A AC+DC TRMS / Hz (A AC) $\rightarrow$	A $\rightarrow$	
A AC / Hz (A AC) $\rightarrow$	A $\sim$	
Hz (A AC+DC) / A AC+DC TRMS $\rightarrow$	A $\rightarrow$	Up to 30 kHz
Hz (A AC) / A AC $\rightarrow$	Hz	

### Scope of Functions, Current Measurement with Current Clamp Sensor

Function	Switch Position
Transformation ratio $\rightarrow$	SET menu, ClIP=OFF
A DC $\rightarrow$	V $\rightarrow$
A AC+DC $\rightarrow$ / Hz (A AC) $\rightarrow$	V $\rightarrow$
Hz (A AC) $\rightarrow$ / A AC+DC $\rightarrow$	Hz
A AC $\rightarrow$ / Hz (A AC) $\rightarrow$	V $\sim$
Hz (A AC) $\rightarrow$ / A AC $\rightarrow$	Hz

### Scope of Functions, Current Measurement with Current Clamp Transformer

Function	Switch Position
Transformation Ratio $\rightarrow$	SET menu, ClIP=OFF
A DC $\rightarrow$	A $\rightarrow$
A AC+DC $\rightarrow$ / Hz (A AC) $\rightarrow$	A $\rightarrow$
Hz (A AC) $\rightarrow$ / A AC+DC $\rightarrow$	A $\rightarrow$
A AC $\rightarrow$ / Hz (A AC) $\rightarrow$	A $\sim$
Hz (A AC) $\rightarrow$ / A AC $\rightarrow$	Hz

## 5.7.1 Direct and Pulsating Current Measurement, Direct Connection, A DC and A (DC+AC)

- First disconnect supply power from the measuring circuit or the power consumer, and discharge any capacitors.
- In accordance with the current to be measured, set the rotary switch to A  $\overline{=}$  or A  $\overline{\approx}$ .
- Select the type of current appropriate for the measured quantity by briefly pressing the multifunction key **FUNC** | **ENTER**. Each time the key is pressed, the instrument is switched back and forth between A DC and A (DC + AC)<sub>TRMS</sub>, which is indicated by means of an acoustic signal. The current type is indicated at the LCD by means of the DC or the (DC+AC)<sub>TRMS</sub> symbol.
- Safely connect the measuring instrument (without contact resistance) in series to the power consumer as shown.
- Switch supply power to the measuring circuit back on.
- Read the display. Make a note of the measured value if the instrument is not being operated in the memory mode or the transmission mode.
- Disconnect supply power from the measuring circuit or the power consumer once again, and discharge any capacitors.
- Remove the test probes from the measuring point and return the measuring circuit to its normal condition.
- Direct frequency measurement, A (DC + AC)<sub>TRMS</sub> (see following section).

**Current measurement may only be performed with installed batteries!**

**FUNC**  
**ENTER**

**Measuring Ranges:**

**300  $\mu$ A / 3 mA**  
**30 mA / 300 mA**  
**3 A / 10 A (10 A max. 5 min)**  
**(16 A max. 30 s)**

\* Additional temperature display (internal temperature at jacks) in the 3 A and 10 A ranges

I > 10 A  
I > 16 A

↑ Current

### 5.7.2 Alternating Current and Frequency Measurement, Direct Connection, A AC and Hz

- ↗ First disconnect supply power from the measuring circuit or the power consumer, and discharge any capacitors.
- ↗ In accordance with the current or frequency to be measured, turn the rotary switch to A~ or Hz.
- ↗ Select the desired measured quantity by briefly pressing the multifunction key **FUNC | ENTER**. Each time the key is pressed, AC<sub>TRMS</sub> and Hz are alternately selected, and switching is acknowledged with an acoustic signal.
- ↗ Safely connect the measuring instrument (without contact resistance) in series to the power consumer as shown.
- ↗ Switch supply power to the measuring circuit back on.
- ↗ Read the display. Make a note of the measured value if the instrument is not being operated in the memory mode or the transmission mode.
- ↗ Disconnect supply power from the measuring circuit or the power consumer once again, and discharge any capacitors.
- ↗ Remove the test probes from the measuring point and return the measuring circuit to its normal condition.

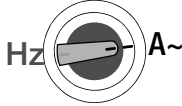

Hz A~

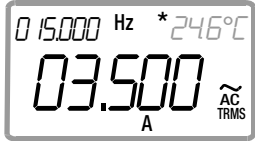

015.000 Hz \*246°C Hz  
03.500 A AC TRMS

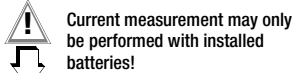

Current measurement may only be performed with installed batteries!



8.8.8.8



FUNC | ENTER

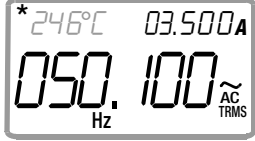

\*246°C 03.500 A A Hz  
050.100 Hz AC TRMS

**Measuring Ranges:**

**300 μA / 3 mA**  
**30 mA / 300 mA**  
**3 A / 10 A (10 A max. 5 min)**  
**(16 A max. 30 s)**

\* Additional temperature display (internal temperature at jacks) in the 3 A and 10 A ranges

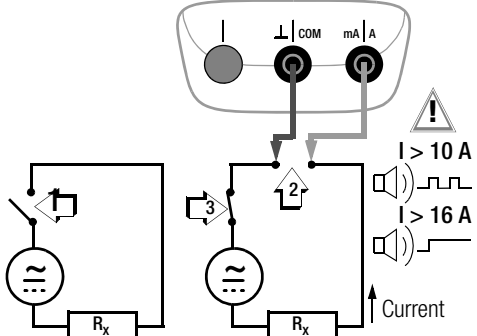

I > 10 A  
I > 16 A  
Current

### 5.7.3 Direct and Pulsating Current Measurement with Current Clamp Sensor, A DC and A (DC+AC)

#### Voltage/Current Transformer Output

When a current clamp sensor is connected to the multimeter (V  $\rightarrow$  input), all current displays appear with the correct value in accordance with the selected transformation ratio. The only prerequisite is that the current sensor is equipped with at least one of the below listed transformation ratios, and that the ratio has been previously selected in the following menu (**CL**, **P**  $\neq$  OFF) (see also section 6.4).

#### Current Clamp Setup Menu

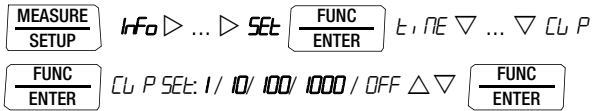

Transformation ratios: CL, P	DMM Measuring Ranges			Clamp Types
	300 mV	3 V	30 V	
<b>1:1</b> 1mV/1mA	300.00 mA	3.0000 A	30.000 A	WZ12C
<b>1:10</b> 1mV/10mA	3.0000 A	30.000 A	300.00 A	WZ12B, Z201A/B METRAFLEX
<b>1:100</b> 1mV/100mA	30.000 A	300.00 A	3000.0 A	Z202A/B, METRAFLEX
<b>1:1000</b> 1 mV/1 A	300.00 A	3000.0 A	30000 A	Z202A/B, Z203A/B, WZ12C, METRAFLEX

The maximum allowable operating voltage is equal to the nominal voltage of the current transformer. When reading the measured value, additional error resulting from the current clamp sensor must also be taken into consideration (default setting: **1:1000**).

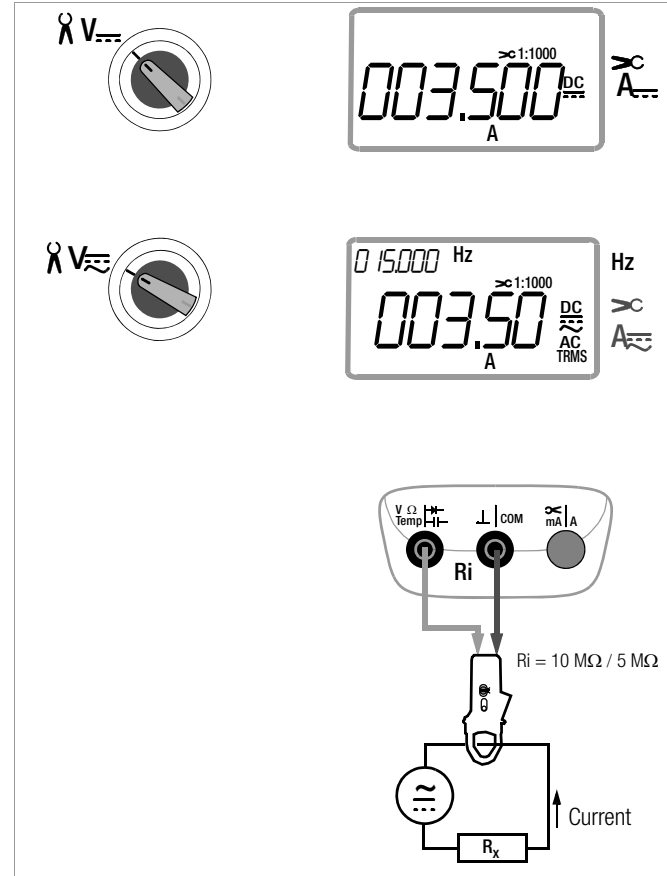

### 5.7.4 Alternating Current Measurement with Current Clamp Sensor, A AC and Hz

#### Voltage/Current Transformer Output

When a current clamp sensor is connected to the multimeter (V  $\sim$  input), all current displays appear with the correct value in accordance with the selected transformation ratio. The only prerequisite is that the current sensor is equipped with at least one of the below listed transformation ratios, and that the ratio has been previously selected in the following menu (CL, P  $\neq$  OFF) (see also section 6.4).

#### Current Clamp Setup Menu

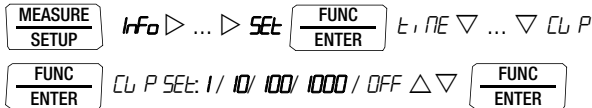

Transformation ratios: CL, P	DMM Measuring Ranges			Clamp Types
	300 mV	3 V	30 V	
<b>1:1</b> 1mV/1mA	300.00 mA	3.0000 A	30.000 A	WZ12C
<b>1:10</b> 1mV/10mA	3.0000 A	30.000 A	300.00 A	WZ12B, Z201A/B METRAFLEX
<b>1:100</b> 1mV/100mA	30.000 A	300.00 A	3000.0 A	Z202A/B, METRAFLEX
<b>1:1000</b> 1 mV/1 A	300.00 A	3000.0 A	30000 A	Z202A/B, Z203A/B, WZ12C, METRAFLEX

The maximum allowable operating voltage is equal to the nominal voltage of the current transformer. When reading the measured value, additional error resulting from the current clamp sensor must also be taken into consideration (default setting: **1:1000**).

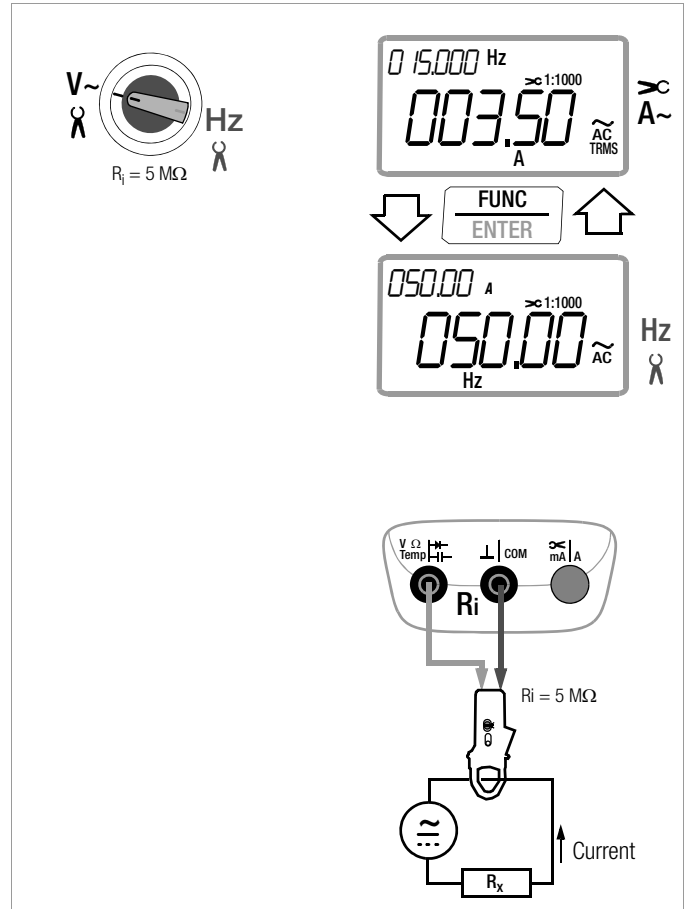

### 5.7.5 Alternating Current Measurement with Current Clamp Transformer, A AC and Hz

#### Current/Current Transformer Output

When a current clamp transformer is connected to the multimeter ( $\rightarrow$  mA/A input), all current displays appear with the correct value in accordance with the selected transformation ratio. The only prerequisite is that the current transformer is equipped with at least one of the below listed transformation ratios, and that the ratio has been previously selected in the following menu (**CL, P**  $\neq$  OFF) (see also section 6.4).

#### Current Clamp Setup Menu

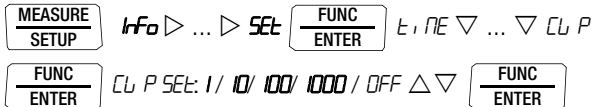

Transformation ratios: <b>CL, P</b>	DMM Measuring Ranges			Clamp Types
	30 mA AC	300 mA AC	3 A AC *	
<b>1:1</b> 1mA/1mA	30.000 mA	300.00 mA	3.0000 A	WZ12A, WZ12D, WZ11A, Z3511, Z3512, Z3514
<b>1:10</b> 1mA/10mA	300.00 mA	3.0000 A	30.000 A	
<b>1:100</b> 1mA/100mA	3.0000 A	30.000 A	300.00 A	
<b>1:1000</b> 1 mA/1 A	30.000 A	300.00 A	3000.0 A	

(default setting: **CL, P** = OFF)

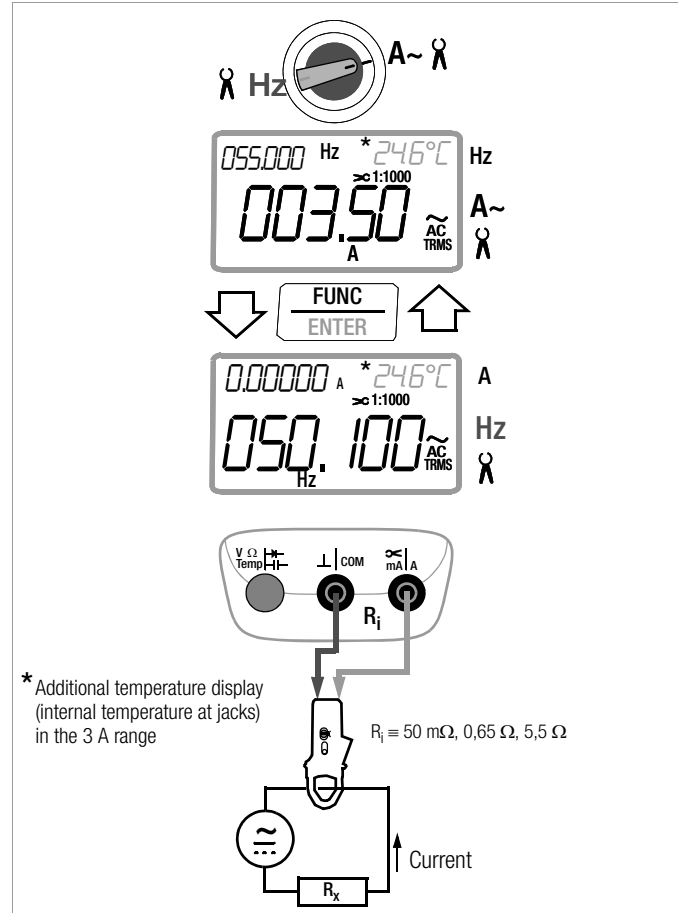



### 6 Device and Measuring Parameters

The instrument's "**SEL**" mode (menu mode) makes it possible to set operating and measuring parameters, query information and activate the interface.

- ⇨ The menu mode is accessed by pressing the **MEASURE | SETUP** key, assuming that the instrument is switched on and set to "Measure" (measuring mode operation). "**Info**" appears at the display.
- ⇨ By repeatedly pressing the  $\triangleleft \triangleright \triangle \nabla$  key (in any direction), access is gained to the following main menus: "**StorE**", "**SEnd**" and "**SEL**", and the display is finally returned to "**Info**".
- ⇨ After selecting the desired main menu, the respective sub-menu is accessed by pressing the **FUNC | ENTER** key.
- ⇨ The desired parameter is selected by repeatedly pressing the  $\triangle \nabla$  key.
- ⇨ In order to check or change a parameter, acknowledge it with the **FUNC | ENTER** key.
- ⇨ The  $\triangleleft \triangleright$  keys can be used to position the cursor at the entry position. The desired value is selected with the help of the  $\triangle \nabla$  keys.
- ⇨ Changes can only be applied with the **FUNC | ENTER** key.
- ⇨ After pressing the **ZERO | ESC** key, the display is returned to the submenu without making any changes, and by pressing the **ZERO | ESC** key once again, to the main menu etc.
- ⇨ You can switch to the measuring mode from any menu level by pressing the **MEASURE | SETUP** key.

After repeatedly pressing the **MEASURE | SETUP** key (without first turning the multimeter off), you can return to the last selected menu or parameter from the measuring mode.

#### Example: Setting Time

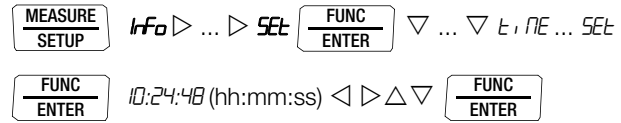

Setting hours and minutes:



Advance to desired entry position.



Change the setting, the entry position blinks.

Press and hold the key to change the setting rapidly.

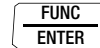

The new time setting is activated after acknowledgment.



6.1 Paths to the Various Parameters

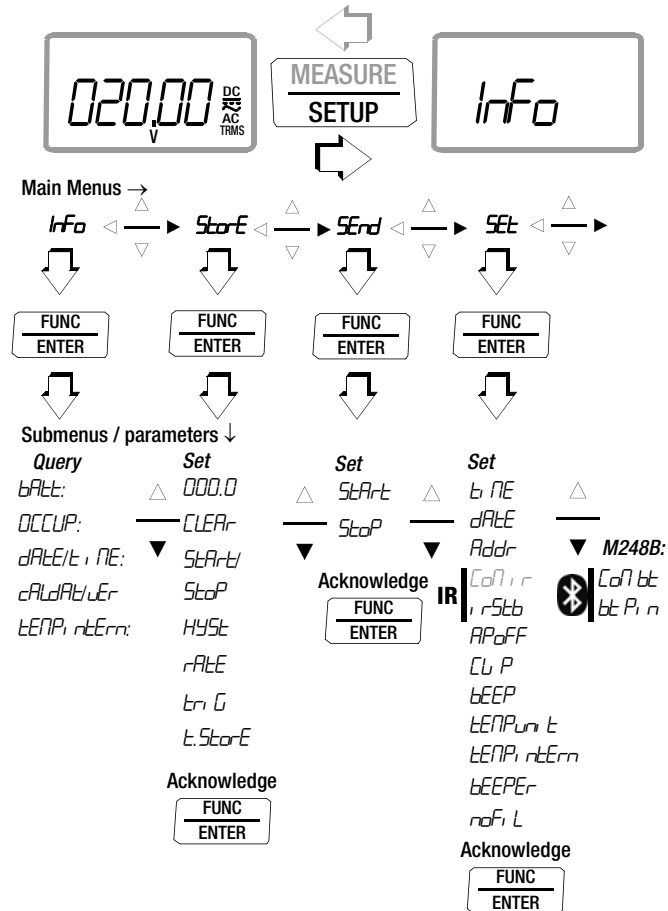

6.2 List of All Parameters

Parameter	Page: Header
<i>Addr</i>	57: Configuring Interface Parameters
<i>APoFF</i>	51: APoFF – Specified Time for Automatic Shutdown and Continuous ON
<i>bAtE</i>	50: bAtt – Query Battery Voltage
<i>bEEP</i>	52: bEEP – Set Limit Value for Continuity Testing
<i>bEEPon/off</i>	52: bEEP on/off – Activate/Deactivate Acoustic Signals
<i>bt Pin</i>	57: bt Pin – Allocating the pin for the Bluetooth interface (M248B)
<i>cALdAt</i>	50: cALdAt – Query Calibration Date
<i>CLER</i>	24: Measurement Data Recording
<i>CLP</i>	44: Direct and Pulsating Current Measurement with Current Clamp Sensor, A DC and A (DC+AC)
<i>CoN bt</i>	57: Interface Selection for METRA HIT ULTRA BT (M248B)
<i>CoN r</i>	57: Interface Selection for METRA HIT ULTRA BT (M248B)
<i>dAtE</i>	50: dAtE – Query Date, 51: dAtE – Enter Date
<i>ENPLY</i>	24: Measurement Data Recording
<i>HYS</i>	53: HYS – Hysteresis (parameter for memory mode operation)
<i>Info</i>	50: Querying Parameters – Info Menu
<i>rStb</i>	57: Configuring Interface Parameters
<i>tEMP</i>	50: tEMP intErn – Query Reference Temperature
<i>noFIL</i>	52: noFIL – quick display of measured values (as from firmwareversion 1.23)
<i>OCCUP</i>	24: Measurement Data Recording
<i>rAtE</i>	53: rAtE – Set Transmission and Storage Rate
<i>SEnd</i>	56: Activating the Interface
<i>SEt</i>	51: Entering Parameters – SETUP Menu
<i>StArT</i>	
<i>StOp</i>	24: Measurement Data Recording
<i>StorE</i>	
<i>tEMP, rAtErn</i>	50: tEMP intErn – Query Reference Temperature
<i>tEMP un t</i>	52: tEMP unit – Select a Unit of Measure for Temperature
<i>t, tNE</i>	50: tIME – Query Time, 51: tIME – Set Time
<i>trIG</i>	54: trIG – Trigger Conditions (parameters for memory mode operation)
<i>tStorE</i>	54: tStorE – Recording Time (parameter for memory mode operation)
<i>vEr</i>	50: vErSion – Query Firmware Version

### 6.3 Querying Parameters – InFo Menu

---



#### bAtt – Query Battery Voltage

 *Info*  bAtt 2.9 V.

#### OCCUP – Query Memory Occupancy



 *Info*  bAtt ... ▾ OCCUP 000.0 %

#### dAtE – Query Date

 *Info*  bAtt ... ▾ 20.06. 20 12 (DD.MM. YY)  
*D = day, M = month, Y = year*

Date and time must be reentered after replacing the batteries.

#### tiME – Query Time

 *Info*  bAtt ... ▾ 13:46:56 (hh:mm:ss)  
*h = hours, m = minutes, s = seconds*

Date and time must be reentered after replacing the batteries.

#### cALdAt – Query Calibration Date

 *Info*  bAtt ... ▾ cALdAt 20.06. 12

#### vErSion – Query Firmware Version

 *Info*  bAtt ... ▾ vEr 0.22

#### ItEMP intErn – Query Reference Temperature

The temperature of the internal reference junction is measured with a temperature sensor in close proximity to the input sockets.

 *Info*  bAtt ... ▾ ItEMP, ntErn 24.7 °C

## 6.4 Entering Parameters – SETUP Menu

### tiME – Set Time

Entering the correct time makes it possible to acquire measured values in real-time.

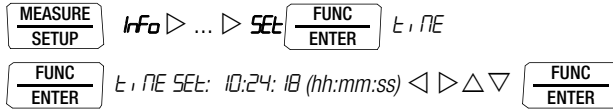

Date and time must be reentered after replacing the batteries.

### dAtE – Enter Date

Entering the current date makes it possible to acquire measured values in real-time.

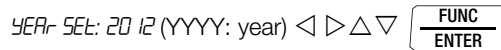
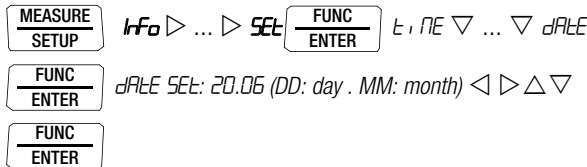

Date and time must be reentered after replacing the batteries.

### Addr – Set Device Address

See section 7.2 on page 57.

### irStb – Status of the Infrared Receiver in the Stand-By Mode

See section 7.2 on page 57 regarding settings.

### CoM ir / CoM bt – Interface Operating System Infrared / Bluetooth

Refer to section 7.2 on page 57 for instructions on switching between the two systems.

### bt pin – Pin for Bluetooth Interface

Refer to section 7.2 on page 57 on setting instructions.

### APoFF – Specified Time for Automatic Shutdown and Continuous ON

The instrument is switched off automatically if the measured value remains unchanged for a long period of time and if none of the keys or the rotary switch have been activated before the specified time “APoFF” (entered in minutes) has elapsed.

If the **on** setting is selected, the multimeter is set to continuous operation and **on** appears in the display to the right of the battery symbol. In this case, the multimeter can only be switched off manually. The “**on**” setting can only be canceled by changing the respective parameter, or by switching the instrument off manually. In this case, the parameter is reset to 10 minutes.



(10 minutes = default setting)



### Note

The auto power off function (**APoFF** parameter) is deactivated when dangerous touch voltage is applied.





---

### CLiP – Set Transformation Ratio (current clamp factor)

See section 5.7.3 ff.

---





### bBEEP – Set Limit Value for Continuity Testing

 Info ▷ ... ▷   t, nE ▾ ... ▾ bBEEP  
 bBEEP SET: 1, 10, 20 ... 500 Ω Δ ▾ 

(10 Ω = default setting)

---

### tEMP unit – Select a Unit of Measure for Temperature

 Info ▷ ... ▷   t, nE ▾ ... ▾ tEMP unit °C  
 unit SET: °C / °F Δ ▾ 

(°C = default setting)

---

**TEMP intErn/ExtErn – Select Internal or External Reference Junction**

External Reference Junction: Specified Temperature

**MEASURE SETUP** IrFo ▷ ... ▷ **SET** **FUNC ENTER** t, rE ▽ ... ▽ tErn, rErn

**FUNC ENTER** tErn SET: tErn, rErn / tErnExtErn Δ ▽ **FUNC ENTER**

ExtErn SET: 0000 °C Δ ▽ **FUNC ENTER**

(internal reference = default setting)

**bEEPEr on/OFF – Activate/Deactivate Acoustic Signals**

**MEASURE SETUP** IrFo ▷ ... ▷ **SET** **FUNC ENTER** t, rE ▽ ... ▽ bEEPEr off

**FUNC ENTER** bEEPEr SET: on / off Δ ▽ **FUNC ENTER**

(bEEPEr on = default setting)

**noFiL– quick display of measured values (as from firmwareversion 1.23)**

For the following functions, a quicker display update rate of up to 5 display values per second (noFiL=ON) instead of 2 display values per second (noFiL=OFF) can be set: V DC, A DC with clamp, A DC direct, Ω, diode measurement.

**MEASURE SETUP** IrFo ▷ ... ▷ **SET** **FUNC ENTER** rAtE ▽ ... ▽ noFiL **FUNC ENTER**

on / OFF Δ ▽ **FUNC ENTER**  
(OFF = Standard value\*/default setting)

\* All specifications refer to the default update rate with measuring parameter noFiL = OFF (default).

**6.5 StorE Menu – Parameter for Memory Mode Operation**

**HYSt – Hysteresis (parameter for memory mode operation)**

The hysteresis setting allows for efficient use of memory space. During memory mode operation, new measured data are only saved if they deviate from the previously stored value by an amount which exceeds the selected hysteresis value.

Hysteresis can be selected in steps from 1 to 10,000 digits. These digits are related to the measuring range as follows: The position of the set digit in the specified hysteresis value corresponds to the same position within the measuring range, although counting is started at the left.

Example: A specified hysteresis of 00100 for the 600.00 V measuring range means that only those measured values which deviate from the last measured value by more than 001.00 V are saved to memory.

 **Note**

Due to the fact that the value is specified in digits (highest place all the way to the left), and thus depends on the measuring range, it's advisable to use the function with a fixed measuring range only.

**MEASURE SETUP** IrFo ▷ ... ▷ **StorE** **FUNC ENTER** ▽ ... ▽ HYSt

**FUNC ENTER** HYSt SET: 00000 ... 10000 ◀ ▶ Δ ▽ **FUNC ENTER**

### rAtE – Set Transmission and Storage Rate

The sampling rate specifies the time interval after which the respective measured value is transmitted to the interface, or to measured value memory.

Any one of the following sampling rates can be selected:

[mm:ss.0] 00:00.1, 00:00.2, 00:00.5, **00:01.0**, **00:02.0**, **00:05.0**  
[h:mm:ss.0] (h = hours, m = minutes, s = sec., 0 = tenths of a sec.)  
0:00:10, 0:00:20, 0:00:30, 0:00:40, 0:00:50, 0:01:00, 0:02:00, 0:05:00,  
0:10:00, 0:20:00, 0:30:00, 0:40:00, 0:50:00, 01:00:00, 02:00:00, 03:00:00,  
**04:00:00**, **05:00:00**, **06:00:00**, **07:00:00**, **08:00:00**, **09:00:00**, **SAMPLE**, **dAtA**  
*(boldface: values or digits which are actually displayed,  
plain: placeholders for unit)*

### Setting the Sampling Rate



(00:00.5 = 0.5 s = default value)

The last selected value is retained, even after switching the instrument off.

If the selected **sampling rate is too short** for the measuring function, the smallest valid sampling rate is used automatically.

If a **sampling rate is selected which is greater than auto power off time** (see APoFF parameter on page 51), the instrument is switched off automatically after auto power off time has elapsed, and back on again roughly 10 seconds before the next measuring point.

### Storage of Individual Values using the SAMPLE or dAtA Sampling Rate

If only manually selected values need to be saved, **SAMPLE** must be selected as the Store > rAtE sampling value. If memory mode operation is then started, a single measured value is saved to permanent memory with time stamp when the **DATA/MIN/MAX** key is pressed and held until two rapidly repeating acoustic signals are generated.

If **dAtA** is selected as the Store > rAtE sampling rate, and if memory mode operation is then started, measured values ascertained with activated DATA function are automatically saved to permanent memory with time stamp.

### triG – Trigger Conditions (parameters for memory mode operation)

The Store > triG SET = Sto-ou / Sto-in / OFF setting can be used to specify how measured value recording is started and stopped:

- **triG = off**: Recording is started with Store > Start and ended with Store > Stop.
- **triG = sto-ou**: Recording is started as soon as a measured value occurs which is outside of the selected measuring limits, and is stopped as soon as the measuring limits are once again complied with, or the selected recording period has elapsed.
- **triG = sto-in**: Recording is started as soon as a measured value occurs which is within a specified band, and is stopped as soon as this is no longer the case, or after the maximum recording period has elapsed.

The band is specified with the help of the L\_triG lower limit and the H\_triG upper limit. Querying takes place in the event that triG OFF is selected. Bandwidths are specified in digits and defined by the measuring range limit, which, in the case of DC for example, corresponds to 300,000 (-300,000 to +300,000). In measuring functions with a small measuring range span (e.g.

V AC with 30,000 digits), it is not useful to set the trigger threshold above this measuring range span. It's thus advisable to perform measurement with a fixed measuring range. Due to the fact that rapid momentary value acquisition (see section 4.5.1) has a large measuring range span, limit values of greater than 30,000 digits can be selected.

Actual measurement is always executed using the sampling rate selected in "Store > rAtE".

 Info ▷ ... ▷ Store  ▾ ... ▾ t<sub>n</sub> G

 t<sub>n</sub> G SET : Store<sub>on</sub> / Store<sub>n</sub> / off △ ▾

 L<sub>t<sub>n</sub> G</sub> SET : - 150000 ... + 150000 △ ▾

 H<sub>t<sub>n</sub> G</sub> SET : - 150000 ... + 150000 △ ▾ 

### tStore – Recording Time (parameter for memory mode operation)

This parameter determines whether or not measured values will be recorded for a limited time only. If recording time will be limited, its duration can be entered in hours, minutes and seconds. "on" means unlimited recording time.



 Info ▷ ... ▷ Store  ▾ ... ▾ t.Store

 t.Store SET : on/99:00:00 (hh:mm:ss) △ ▾ 

After completion of the recording time t.Store, the end of the storage process is signalled by 2 short acoustic signals (as from firmware version V1.14).

### 6.6 Default Settings

Previously entered changes can be undone, and default settings can be restored. This may be advisable under the following circumstances:

- After the occurrence of software or hardware errors
  - If you are under the impression that the multimeter does not work correctly
- ⇒ **Disconnect the device from the measuring circuit.**
- ⇒ Remove the batteries temporarily (see also section 9.2).
  - ⇒ Simultaneously press and hold the  and  keys and reinsert the batteries at the same time, which is acknowledged with two acoustic signals.

### 7 Interface Operation

The multimeters are equipped with an infrared interface for the transmission of measurement data to a PC. Measured data are optically transferred through the instrument housing by means of infrared light to an interface adapter (accessory), which is attached to the multimeter. The adapter's USB interface allows for connection to the PC with an interface cable.

Model **METRAHIT ULTRA BT** (M248B) optionally allows for the wireless data transfer via Bluetooth to a PC, smartphone or tablet PC (based on Android operating system). Information on the smartphone app **METRALOG** is available in section 10.4.2.

Commands and parameters can be transmitted from the PC to the multimeter in both interface operating systems as well. The following functions can be executed:

- Configure and read out measuring parameters
- Select a measuring function and a measuring range
- Start measurement
- Read out stored measured values

#### 7.1 Activating the Interface

The interface is automatically activated for receiving operation (multimeter receives data from the PC) as soon as the interface is addressed by the PC, assuming that the “*IrStb*” parameter has been set to “*1 on*” (see section 7.2), or the instrument is already switched on (the first command wakes up the multimeter, but does not yet execute any further commands).

To activate the Bluetooth interface, set parameter „*CoPi r*“ to „*CoPi t*“ and allocate an access key (pin) via „*tPin*“, see section 7.2. The Bluetooth interface is inactive when the multimeter is switched off.

The “continuous transmission” operating mode is selected manually as described below. In this operating mode, the instrument continuously transmits measurement data to the PC via the interface adapter, which can then be displayed with the help of a terminal program.

#### Starting Continuous Transmission Operation with Menu Functions

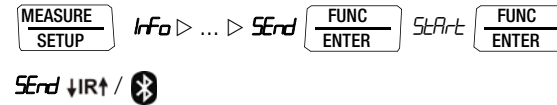

**IR interface:** IR and an arrow pointing to the right blink during transmission mode operation.

**Bluetooth interface:** During radio communication to the PC or smartphone, symbol and the two cursors are flashing.

#### Stopping Continuous Transmission Operation with Menu Functions

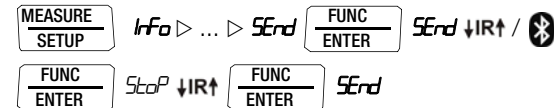

#### Automatic Activation and Deactivation of Transmission Mode Operation

If the sampling rate is 10 seconds or longer, the display is switched off automatically between samples in order to prolong battery service life. The only exception is when the multimeter is set to continuous operation. As soon as an event occurs, the display is automatically switched back on.



## 7.2 Configuring Interface Parameters

### IrStb – Status of the Infrared Receiver in the Stand-by Mode

There are two possible switching statuses for the infrared interface when the multimeter is switched off (refers to METRAHIT ULTRA (M248A) and METRAHIT ULTRA BT (M248B), if CdIr has been set):

- iron*: IR appears at the display and the infrared interface is active, i.e. signals such as making commands can be received, and power is consumed even though the multimeter is switched off.
- roff*: IR does not appear at the display and the infrared interface is switched off, signals cannot be received.

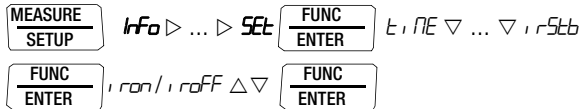

(*iron* = *iron* = default setting,  
*roff* = *roff* = status upon delivery)

### Interface Selection for METRAHIT ULTRA BT (M248B)

- CdIr**: Symbol IR for infrared is shown in the display, the infrared interface is selected and is either active or not active, depending on the parameter setting for *iron*, see above. The Bluetooth interface is deactivated.
- Cdbt**: Symbol  for Bluetooth is shown in the display, the Bluetooth interface is active. The infrared interface is deactivated.

### Switching from IR to Bluetooth:

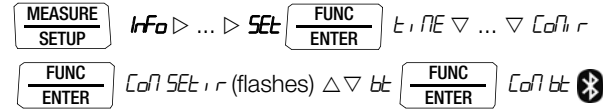

### Switching from Bluetooth to IR:

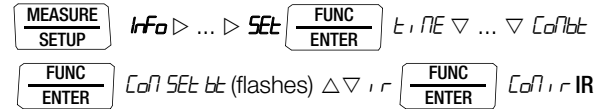

### bt Pin – Allocating the pin for the Bluetooth interface

The pin entered at the multimeter must correspond to the pin at the PC or smartphone.

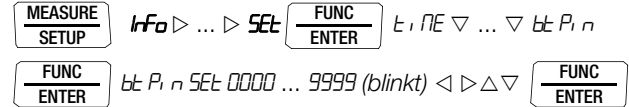

### Addr – Multimeter Address

If several multimeters are connected to the PC via an interface adapter, a separate address can be assigned to each instrument. Address number 1 should be selected for the first instrument, 2 should be assigned to the second and so forth.

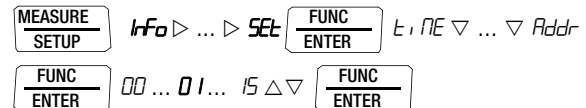

(15 = default setting)

8 Technical Data

Meas. Function	Measuring Range	Resolution at Upper Range Limit			Input impedance		Intrinsic Uncertainty under Reference Conditions			Overload Capacity <sup>12</sup>	
		DC	AC/AC+DC				$\pm(\dots \% \text{ rdg} + \% \text{ MR} + \dots \text{ d})$	$\pm(\dots \% \text{ rdg} + \dots \text{ d})$	$\pm(\dots \% \text{ rdg} + \dots \text{ d})$		
		309,999	30,999	3099	$\equiv$	$\sim / \approx$	$\equiv$	$\sim$	$\approx^2$	Value	Time
<b>V</b>	300 mV	1 $\mu$ V	10 $\mu$ V		>10 M $\Omega$	> 5 M $\Omega$ // < 50 pF	0.02 + 0.005 + 10 with ZERO	0.5 + 30 <sup>2</sup>	0.5 + 30	600V DC AC RMS sine	Max. 10 sec.
	3 V	10 $\mu$ V	100 $\mu$ V		>10 M $\Omega$	> 5 M $\Omega$ // < 50 pF	0.02 + 0.005 + 5	0.2 + 30 <sup>1</sup>	0.5 + 30		
	30 V	100 $\mu$ V	1 mV		>10 M $\Omega$	> 5 M $\Omega$ // < 50 pF	0.02 + 0.005 + 5				
	300 V	1 mV	10 mV		>10 M $\Omega$	> 5 M $\Omega$ // < 50 pF	0.02 + 0.005 + 5				
	600 V	10 mV	100 mV		>10 M $\Omega$	> 5 M $\Omega$ // < 50 pF	0.02 + 0.005 + 5				
<b>dB</b>	0.3 V / 3 V ... 600 V~			0.01 dB	Display Range for Reference Voltage U <sub>REF</sub> = 0.775 V			Intrinsic Uncertainty		600 V AC RMS sine	Cont.
					-42 dB ... + 57 dB			0.1 dB (U > 10% MR)			
<b>A</b>		DC	AC/AC+DC		Voltage drop at approx. range limit		$\equiv$	$\sim^2$	$\approx^2$		
	300 $\mu$ A	1 nA	10 nA		170 mV		0.05 + 0.02 + 5 with ZERO	0.5 + 30	0.5 + 30	0.7 A	Cont.
	3 mA	10 nA	100 nA		170 mV		0.05 + 0.01 + 5				
	30 mA	100 nA	1 $\mu$ A		170 mV		0.02 + 0.01 + 5				
	300 mA	1 $\mu$ A	10 $\mu$ A		200 mV		0.1 + 0.05 + 5				
	3 A	10 $\mu$ A	100 $\mu$ A		150 mV		0.2 + 0.05 + 5 with ZERO				
10 A	100 $\mu$ A	1 mA		470 mV		0.2 + 0.05 + 5	0.7 + 30	0.7 + 30	10 A: $\leq$ 5 min. <sup>10,11</sup>	16 A: $\leq$ 30 s <sup>11</sup>	
<b>A</b> $\curvearrowright$	Factor: 1:1/10/100/1000		Input		Input impedance						
	0.03, 0.3, 3, 30 A		30 mA		Current measurement input ( $\curvearrowright$ Asocket)		See current measuring ranges for specification. Plus current transformer clamp error			Measurement input 0.7 A cont. 3 A: 5 min.	
	0.3, 3, 30, 300 A		300 mA								
3/30/300/3000 A		3 A									
<b>A</b> $\curvearrowright$	0.3, 3, 30, 300 A 3/30/300/3000 A		300 mV 3 V / 30 V		Voltage measurement input (V jack) Ri = 5 M $\Omega$ /10 M $\Omega$		See voltage measuring ranges for specification.			Measurement input 600 V TRMS	
<b><math>\Omega</math></b>					Open-circuit voltage	Measuring current at range limit	$\pm(\dots \% \text{ rdg.} + \% \text{ MR} \dots \text{ d})$				
	300 $\Omega$	1 m $\Omega$			< 2 V	Approx. 0.5 mA	0.05 + 0.01 + 5 with ZERO			600 V DC AC RMS sine	Max. 10 sec. (PTC)
	3 k $\Omega$	10 m $\Omega$			< 2 V	Approx. 130 $\mu$ A	0.05 + 0.01 + 5 with ZERO				
	30 k $\Omega$	100 m $\Omega$			< 2 V	Approx. 20 $\mu$ A	0.05 + 0.01 + 5				
	300 k $\Omega$	1 $\Omega$			< 2 V	Approx. 2 $\mu$ A	0.05 + 0.01 + 5				
	3 M $\Omega$	10 $\Omega$			< 2 V	Approx. 1 $\mu$ A	0.1 + 0.02 + 5				
30 M $\Omega$	100 $\Omega$			< 2 V	Approx. 200 nA	1 + 0.2 + 5					
$\rightarrow$ )	300 $\Omega$	—	0.1 $\Omega$		< 4.5 V	Approx. 1 mA const.	1 + 5 with ZERO			600 V	Max. 10 sec.
$\rightarrow$	4.5 V <sup>3</sup>	—	1 mV		< 6 V	Approx. 1 mA const.	0.2 + 3			600 V	Max. 10 sec.

Meas. Function	Measuring Range	Resolution at Upper Range Limit			Conditions	Intrinsic Uncertainty under Reference Conditions		Overload Capacity <sup>12</sup>			
		309,999	30,999	3099				Value	Time		
<b>F</b>					<b>Discharge resistance</b>	<b>U<sub>0 max</sub></b>	±(... % rdg. + ... d) <sup>4</sup>		600 V DC AC RMS sine	Max. 10 s	
	3 nF	—	—	1 pF	1 MΩ	2 V	2 + 15 with ZERO function active				
	30 nF	—	—	10 pF	1 MΩ	2 V	1 + 6 with ZERO function active				
	300 nF	—	—	100 pF	100 kΩ	2 V	1 + 6				
	3 μF	—	—	1 nF	100 kΩ	2 V					
	30 μF	—	—	10 nF	10 kΩ	2 V	5 + 6				
	300 μF	—	—	100 nF		2 V					
3 mF	—	—	1 μF	2.5 kΩ	2 V						
<b>Hz (V)</b>	300 Hz	0.001 Hz				<b>f<sub>min</sub></b> <sup>5</sup>	±(... % rdg. + ... d)				
<b>Hz (A)</b>	3 kHz	0.01 Hz				5 Hz	Hz(V) 0.05 + 2 <sup>8</sup> Hz(A) 0.05 + 3 <sup>8</sup>		Hz(V) <sup>6, 8</sup> 600 V Hz(A) <sup>7</sup>	Max. 10 s	
<b>Hz (A&gt;C)</b>	30 kHz	0.1 Hz				10 Hz					
<b>Hz (V)</b>	300 kHz	1 Hz				1 Hz					
<b>MHz</b>	300 Hz to 1 MHz	0.01...100 Hz						> 3 V ... 5 V	600 V	Max. 10 s	
<b>%</b>	2.00 ... 98.00%		—	0.01 %	15 Hz ... 1 kHz			0.1 MR ± 10 d	> 3 V ... 5 V	600 V	Max. 10 s
	5.00 ... 95.00%		—	0.01%	1 ... 10 kHz			0.1 MR per kHz ± 10 d	> 3 V ... 5 V		
<b>°C/°F</b>	Pt100	- 200.0 ... + 100.0 °C						±(... % rdg. + ... d)		600 V DC/AC RMS sine	Max. 10 s
	Pt1000	+ 100.0 ... + 850.0 °C		0.1 K				0.3 + 10 <sup>9</sup>			
	K (NiCr-Ni)	- 270.0 ... + 1372.0 °C							1% + 2.0 K <sup>9</sup>		

<sup>1</sup> Specified accuracy valid as of 1% of the measuring range

<sup>2</sup> Specified accuracy valid as of 2% of the measuring range

<sup>3</sup> Display of up to max. 4.5 V, above which overload display appears: "OL"

<sup>4</sup> Applies to measurements at film capacitors during battery operation

<sup>5</sup> Lowest measurable frequency for sinusoidal measuring signals symmetrical to the zero point

<sup>6</sup> Overload capacity of the voltage measurement input:

power limiting: frequency x voltage max. 3 x 10<sup>9</sup> V x Hz for U > 100 V

<sup>7</sup> Overload capacity of the current measurement input: see current measuring ranges for max. current values

<sup>8</sup> Input sensitivity, sinusoidal signal: 10% to 100% of voltage/current measuring range; in the 300 kHz range the specified intrinsic uncertainty applies as from 15% of MR

<sup>9</sup> Plus sensor deviation

<sup>10</sup> As of a measured value of 7 A, measurement is limited to an ambient temperature

of 30 °C or a maximum duration of 5 minutes.

<sup>11</sup> Off-time > 30 min. and T<sub>A</sub> ≤ 40 °C after a 10 or 16 A measurement

<sup>12</sup> At 0 ° ... + 40 °C

**Key:** d = digit(s), MR = measuring range, rdg. = reading (measured value)

**Influencing Quantities and Influence Error**

Influencing Quantity	Sphere of Influence	Measured Quantity / Measuring Range <sup>1</sup>	Influence Error (...% rdg. + ... d) / 10 K
Temperature	0° C ... +21° C and +25° C ... +40° C	V $\bar{\bar{=}}$	0.05 + 5
		V $\sim$ , V $\bar{\bar{=}}$ , dB	0.2 + 10
		300 $\Omega$ ... 30 M $\Omega$ , $\varnothing$ )	0.1 + 10
		A $\bar{\bar{=}}$ , A $\sim$ , A $\bar{\bar{=}}$	0.3 + 10
		30 nF, 300 nF, 3 $\mu$ F, 30 $\mu$ F	0.5 + 10
		3 nF, 300 $\mu$ F	3 + 10
		Hz	0.05 + 5
		$\rightarrow$	0.1 + 5
		°C/°F (Pt100/Pt1000)	0.1 + 10
		°C/°F thermocouple K <sup>2</sup>	0.1 + 10

<sup>1</sup> With zero balancing

<sup>2</sup> Prerequisite: stable ambient temperature (t > 30 min.)

Influencing Quantity	Measured Quantity	Influence Error (...% rdg. + ... d)
DATA	V, A, $\Omega$ , Hz, dB, °C	$\pm$ 10 d
MIN / MAX	V, A, $\Omega$ , Hz, dB, °C	$\pm$ 30 d

Influencing Quantity	Measured Quantity / Measuring Range	Sphere of Influence	Intrinsic Uncertainty $\pm$ (... % rdg. + ... d) <sup>1</sup>	
Frequency	V <sub>AC</sub> V <sub>AC+DC</sub>	300.00 mV ... 30.000 V <sup>3</sup>	> 15 Hz ... 45 Hz	2 + 30
			> 65 Hz ... 1 kHz	0.5 + 30
		300.00 V <sup>3</sup> 600.00 V <sup>3</sup>	> 1kHz ... 20 kHz	2 + 30
			> 20kHz ... 100 kHz	3 + 30 <sup>2</sup>
	I <sub>AC</sub> I <sub>AC+DC</sub>	300 $\mu$ A ... 10 A	> 15 Hz ... 45 Hz	2 + 30
			> 65 Hz ... 5 kHz	2 + 30
			> 5kHz ... 20 kHz	3 + 30
			> 65 Hz ... 65 Hz	3 + 30 <sup>4</sup>
		> 65 Hz ... 10 kHz		

<sup>1</sup> Intrinsic uncertainty in the frequency response applies as of 10% ... 100% of the measuring range.

<sup>2</sup> Signals > 50 kHz: plus 5%

<sup>3</sup> Power limiting: frequency x voltage max.  $3 \times 10^6$  V x Hz where U > 100 V

<sup>4</sup> the following applies for the 300  $\mu$ A measuring range: 7 + 30

Influencing Quantity	Sphere of Influence	Measured Quantity / Measuring Range	Influence Error <sup>5</sup>
Crest Factor CF	1 ... 3	V $\sim$ , A $\sim$	$\pm$ 1% rdg.
	> 3 ... 5		$\pm$ 3% rdg.

<sup>5</sup> Except for sinusoidal waveform

Influencing Quantity	Sphere of Influence	Measured Quantity	Influence Error
Relative Humidity	75%	V, A, $\Omega$ , F, Hz, dB, °C	1 x intrinsic error
	3 days		
	instrument off		
Battery voltage	Range: 1.8 ... 3.6 V	ditto	Included in intrinsic error

Influencing Quantity	Sphere of Influence	Meas. Quantity / Measuring Range	Damping
Common Mode Interference Voltage	Interference quantity: max. 600 V $\sim$	V $\equiv$ (3 V ... 600 V MR)	> 120 dB
	Interference quantity: max. 600 V $\sim$ 50 Hz ... 60 Hz, sine	3 V $\sim$	> 60 dB
		30 V $\sim$	> 65 dB
		300 V/600 V $\sim$	> 50 dB
Series Mode Interference Voltage	Interference quantity: V $\sim$ , respective nominal value of the measuring range, max. 600 V $\sim$ , 50 Hz ... 60 Hz sinusoidal	V $\equiv$	> 70 dB
	Interference quantity: max. 600 V $\equiv$	V $\sim$	> 120 dB

### Reference Conditions

Ambient temperature	+23 °C $\pm$ 2 K
Relative humidity	40 ... 75%, no condensation allowed
Meas. quantity frequency	Range: 45 ... 65 Hz
Meas. quantity waveform	Sinusoidal
Battery voltage	Range: 1.8 ... 3.2 V

### Response Time (after manual range selection)

Measured Quantity / Measuring Range	Response Time, Digital Display	Jump Function of the Measured Quantity
V $\equiv$ , V $\sim$ , dB A $\equiv$ , A $\sim$	1.5 s	From 0 to 80% of upper range limit value
3 nF ... 300 $\mu$ F	Max. 3 s	
300 $\Omega$ ... 3 M $\Omega$	3 s	From $\infty$ to 50% of upper range limit value
30 M $\Omega$	8 s	
Continuity	< 50 ms	
°C (Pt100)	Max. 3 s	
$\rightarrow$	1.5 s	

Measured Quantity / Measuring Range	Response Time, Digital Display	Jump Function of the Measured Quantity
>10 Hz	1.5 s	From 0 to 50% of upper range limit value

### Internal clock

Time format	DD.MM.YYYY hh:mm:ss
Resolution	0.1 sec.
Accuracy	$\pm$ 1 minute per month
Temperature influence	50 ppm/K

### Data Interface – Infrared

Type	Optical via infrared light through the housing
Data transmission	Serial, bidirectional (not IrDa compatible)
Protocol	Device specific
Baud rate	38,400 baud
Functions	<ul style="list-style-type: none"> <li>– Select/query measuring functions and parameters</li> <li>– Query/transmit momentary measurement data</li> <li>– Read out stored measurement data</li> </ul>

The USB X-TRA plug-in interface adapter (see accessories) is used for adaptation to the PC's USB port.

### Data Interface – Bluetooth (M248B only)

The **METRAHIT ULTRA BT** Bluetooth multimeter variant (M248B) is identical to the **METRAHIT ULTRA** (M248A), except that it is also equipped with a Bluetooth interface.

Wireless data exchange via Bluetooth is an alternative to the optional IR-USB cable connection using the USB X-TRA accessory (Z216C).

The **METRAHIT ULTRA BT** with Bluetooth interface is connected directly to the Bluetooth interface of a Windows PC or smartphone (Android). However, no communication takes place with peripheral devices such as printers, scanners and the like.

The class 2 Bluetooth module which is integrated in the instrument achieves transmission ranges of up to 20 m, depending on propagation conditions.

Remote control via Bluetooth is identical to corresponding communication via an IR-USB connection.

The only prerequisite for wireless data exchange between multimeter and PC or smartphone (Android) is switching from Infrared to Bluetooth and authentication by means of an access code which must be set at the multimeter and at the PC or smartphone, see section 7.2.

Information on the smartphone app **METRALOG** is available in section 10.4.2.

---

### Internal Measured Value Storage

Memory capacity      16 MBit (2 MByte) for approx. 300,000 measured values with time stamp

### Power Supply

Battery

2 ea. 1.5 V mignon cell (size AA), alkaline manganese per IEC LR6 (2 ea. 1.2 V NiMH rechargeable battery also possible)

Service life

With alkaline manganese: approx. 200 hrs.  
**METRAHIT ULTRA BT:** When the Bluetooth interface is activated, power consumption rises considerably and the service life is reduced accordingly.

Battery test

Battery capacity display with battery symbol in 4 segments: .  
Querying of momentary battery voltage via menu function.

Power OFF function

The multimeter is switched off automatically:  
– If battery voltage drops to below approx. 1.8 V  
– If none of the keys or the rotary switch are activated for an adjustable duration (10 to 59 min.) and the multimeter is not in the continuous operation mode

Power pack socket

If the NA X-TRA power pack has been plugged into the instrument (see accessories), the installed batteries are disconnected automatically.  
Rechargeable batteries can only be recharged externally.

## Display

Transreflective LCD panel (65 x 36 mm) with display of up to 3 measured values, unit of measure, type of current and various special functions.



## Background Illumination

Background illumination is switched off approximately 1 minute after it has been activated.

## Digital

Display / Char. Height	7-segment characters, main display: 13 mm, auxiliary display: 7.5 mm
Number of places	309,999 steps
Overflow display	"OL" is displayed for $\geq 310,000 + 1$ digit
Polarity display	"-" (minus sign) is displayed if plus pole is connected to "1"
Measuring rate	10 measurements per second, 40 measurements per second with Min-Max function except with capacitance, frequency and duty cycle measuring functions
Refresh Rate	2 times per second, every 500 ms (Standard*: noFIL=OFF) 5 x/s (Parameter noFIL=on)

\* All specifications refer to the default update rate with measuring parameter noFIL = OFF (default).

## Acoustic Signals

For voltage	which exceeds 600 V in the 600 V range: intermittent signal (250 ms on, 250 ms off)
For current	which exceeds 10 A: intermittent signal which exceeds 16 A: continuous – For displayed temperature > 50 °C

## Fuse

Fuse link	FF (UR) 10 A/1000 V AC/DC, 10 x 38 mm, breaking capacity: 30 kA at 1000 V AC/DC, protects the current input socket in the 300 μA to 10 A ranges
-----------	---

## Electrical Safety

Per IEC 61010-1:2010/VDE 0411-1:2011		
Protection class	II	
Measuring category	CAT III	CAT IV
Operating voltage	600 V	300 V
Pollution degree	2	
Test Voltage	5.2 kV~	

## Technical Data

---

### Electromagnetic Compatibility (EMC)

Interference emission EN 610326-1:2013, class B  
Interference immunity EN 610326-1:2013  
EN 610326-2-1:2013

---

### Ambient Conditions

Accuracy range 0 °C to +40 °C  
Operating temp. range  $T_A$  -10 °C ... +50 °C \*  
Storage temp. range -25 °C ... +70 °C (without batteries)  
Relative humidity Max. 75%, no condensation allowed  
Elevation To 2000 m  
Deployment Indoors, except within specified ambient conditions

\* Exception: current > 10 A to 16 A, operation at up to 40 °C

---

### Mechanical Design

Housing Impact resistant plastic (ABS)  
Dimensions 200 x 87 x 45 mm  
(without rubber holster)  
Weight Approx. 0.4 kg with batteries  
Protection Housing: IP 52  
Sockets: IP 20

Table Excerpt Regarding Significance of IP Codes

IP XY (1 <sup>st</sup> digit X)	Protection Against Foreign Object Entry	IP XY (2 <sup>nd</sup> digit Y)	Protection Against Penetration by Water
2	≥ 12.5 mm dia.	0	Not protected
5	Dust protected	2	Dripping (at 15° angle)





## 9 Maintenance and Calibration



### Attention!

Disconnect the instrument from the measuring circuit before opening the battery compartment lid or fuse cover in order to replace batteries or fuses!

### 9.1 Displays – Error Messages

Message	Function	Meaning
<i>FUSE</i>	Current measurement	Blown fuse
	In all operating modes	Battery voltage has fallen below 1.8 V
<i>OL</i>	Measuring	Indicates overflow

### 9.2 Batteries



#### Note

#### Removing the Batteries During Periods of Non-Use

The integrated quartz movement draws power from the batteries even when the instrument is switched off. It's advisable to remove the batteries during long periods of non-use for this reason (e.g. vacation). This prevents excessive depletion of the batteries, which may result in damage under unfavorable conditions.



#### Note

#### Battery Replacement

Stored measurement data are lost when the batteries are replaced. The selected operating parameters remain in memory, although date and time must be reentered.

### Charge Level

The current battery charge level can be queried in the “*Info*” menu:



Make sure that no battery leakage has occurred before initial start-up, as well as after long periods of storage. Continue to inspect the batteries for leakage at short, regular intervals.

If battery leakage has occurred, carefully and completely clean the electrolyte from the instrument with a damp cloth, and replace the battery before using the instrument.

If the “” symbol appears at the display, the batteries should be replaced as soon as possible. You can continue working with the instrument, but reduced measuring accuracy may result.

The instrument requires two 1.5 V batteries in accordance with IEC R 6 or IEC LR 6, or two equivalent rechargeable NiMH batteries.

## Replacing the Batteries



### Attention!

Disconnect the instrument from the measuring circuit before opening the battery compartment lid in order to replace the batteries.

- ⇨ Set the instrument face down onto the working surface.
- ⇨ Turn the slotted screw on the lid with the battery symbols counterclockwise.
- ⇨ Lift off the lid and remove the batteries from the battery compartment.
- ⇨ Insert two new 1.5 V mignon batteries into the battery compartment, making sure that the plus and minus poles match up with the provided polarity symbols.
- ⇨ When replacing the battery compartment lid, insert the side with the guide hooks first. Tighten the screw by turning it clockwise.
- ⇨ Please dispose of depleted batteries in accordance with environmental protection regulations!

## 9.3 Fuse

### Testing the Fuse

The fuse is tested automatically:

- When the instrument is switched on with the rotary switch in the A position
- When the instrument is already on and the rotary switch is turned to the A position
- In the active current measuring range when voltage is applied

If the fuse is blown or has not been inserted, “FuSE” appears at the digital display. The fuse interrupts the current measuring ranges. All other measuring ranges remain functional.



### Replacing the Fuse

If a fuse should blow, eliminate the cause of overload before placing the instrument back into service!



### Attention!

Disconnect the instrument from the measuring circuit before opening the fuse cover in order to replace the fuse!

- ⇨ Set the instrument face down onto the working surface.
- ⇨ Turn the slotted screw on the cover with the fuse symbol counterclockwise.
- ⇨ Lift off the cover and pry the fuse out using the flat side of the fuse cover.
- ⇨ Insert a new fuse. Make sure that the fuse is centered, i.e. between the tabs at the sides.
- ⇨ When replacing the fuse cover, insert the side with the guide hooks first. Tighten the screw by turning it clockwise.
- ⇨ Dispose of the blown fuse with the trash.



### Attention!

Use specified fuses only!

If fuses with other blowing characteristics, other current ratings or other breaking capacities are used, the operator is placed in danger, and protective diodes, resistors and other components may be damaged.

The use of repaired fuses or short-circuiting the fuse holder is prohibited.

---



### Note

#### Testing the Fuse with the Instrument Switched On

After inserting the fuse with the instrument switched on, the instrument must be switched off briefly and then switched back on again, or briefly switched to a non-current measuring range and then back to the A measuring range.

If contact is poor or the fuse is blown, FUSE appears at the display.

---

### 9.4 Housing Maintenance

No special maintenance is required for the housing. Keep outside surfaces clean. Use a slightly dampened cloth for cleaning. Avoid the use of cleansers, abrasives or solvents.

### 9.5 Return and Environmentally Sound Disposal

The **instrument** is a category 9 product (monitoring and control instrument) in accordance with ElektroG: German electrical and electronic device law). This device is subject to the RoHS directive. Furthermore, we make reference to the fact that the current status in this regard can be accessed on the Internet at [www.gossenmetrawatt.com](http://www.gossenmetrawatt.com) by entering the search term WEEE.

We identify our electrical and electronic devices in accordance with WEEE 2012/19/EU and ElektroG using the symbol shown at the right per DIN EN 50419.



These devices may not be disposed of with the trash.

Please contact our service department regarding the return of old devices (see address on page 4).

If the **batteries** used in your instrument or accessory product are depleted, they must be disposed of properly in accordance with valid national regulations.

Batteries may contain pollutants and heavy metals such as lead (Pb), cadmium (Cd) and mercury (Hg).

The symbol at the right indicates that batteries must not be disposed of with the trash, and must be brought to a designated collection point.



## 9.6 Recalibration

The measuring tasks performed with your instrument, and the stressing it's subjected to, influence aging of its components and may result in deviation from the specified levels of accuracy.

In the case of strict measuring accuracy requirements, as well as in the event of use at construction sites with frequent stress due to transport and considerable temperature fluctuation, we recommend a relatively short calibration interval of once per year. If your instrument is used primarily in the laboratory and indoors without considerable climatic or mechanical stressing, a calibration interval of once every 2 to 3 years is sufficient as a rule.

During recalibration at an accredited calibration laboratory (DIN EN ISO/IEC 17025), deviations from traceable standards demonstrated by your measuring instrument are documented. Ascertained deviations are used to correct displayed values during later use of the instrument.

We would be happy to perform DAkkS or factory calibration for you at our calibration laboratory. Further information is available at our website:

[www.gossenmetrawatt.com](http://www.gossenmetrawatt.com) (→ Company → DAkkS Calibration Center or → FAQs → Calibration Questions and Answers).

Recalibration of your instrument at regular intervals is essential for the fulfillment of requirements according to quality management systems per DIN EN ISO 9001.

\* Examination of the specification, as well as adjustment, are not included in calibration. However, in the case of our own products, any required adjustment is performed and adherence to the specification is confirmed.

## 9.7 Manufacturer's Guarantee

All **METRA HIT** digital multimeters and calibration instruments are guaranteed for a period of 3 years after date of shipment. The manufacturer's guarantee covers materials and workmanship. Damages resulting from use for any other than the intended purpose or operation errors, as well as any and all consequential damages, are excluded.

The calibration certificate confirms that the product conformed to the specified technical data at the time of calibration. We guarantee the observance of the specified technical data within the admissible tolerance limits for a period of 12 months from delivery.

### 10 Accessories

#### 10.1 General

The extensive accessories available for our measuring instruments are checked for compliance with currently valid safety regulations at regular intervals, and are expanded as required for new applications. Currently up-to-date accessories which are suitable for your measuring instrument are listed at the following web address along with photo, order number, description and, depending upon the scope of the respective accessory, data sheet and operating instructions:

[www.gossenmetrawatt.de](http://www.gossenmetrawatt.de) (→ **Products** → Measuring Technology – Portable → Multimeters → METRAHIT ... →  Accessories).

#### 10.2 Technical Data for Measurement Cables (scope of delivery: KS17-2 safety cable set)

##### Electrical Safety

Maximum rated voltage	600 V	1000 V	1000 V
Measuring category	CAT IV	CAT III	CAT II
Max. rated current:	1 A	1 A	16 A
With safety cap attached	•	•	—
Without safety cap	—	—	•

Observe the measuring instrument's maximum values for electrical safety.

##### Ambient Conditions (EN 61010-031)

Temperature	-20 °C ... + 50 °C
Relative humidity	Max. 80%
Pollution degree	2

#### Using the KS17-2 Cable Set



##### Attention!

Measurements per DIN EN 61010-031 may only be performed in environments in accordance with measuring categories III and IV with the safety cap attached to the test probe at the end of the measurement cable.

In order to establish contact inside 4 mm jacks, the safety caps have to be removed by prying open the snap fastener with a pointed object (e.g. the other test probe).

#### 10.3 NA X-TRA Power Pack (not included)

Use power packs from GMC-I Messtechnik GmbH only in combination with your instrument. This assures operator safety by means of an extremely well insulated cable, and safe electrical isolation (nominal secondary ratings: 5 V / 600 mA). Installed batteries are disconnected electronically if the power pack is used, and need not be removed from the instrument.



##### Note

Use of the power pack may result in significant deviations for the following measuring functions:  
mV AC,  $\mu$ A AC and capacitance measurement.  
We recommend battery operation in this case.

## 10.4 Interface Accessories (not included)

### 10.4.1 Infrared Interface

#### USB X-TRA Bidirectional Interface Adapter

STARLINE multimeters which are equipped with a serial IrDa interface can be connected to a USB port at a PC with the adapter. The adapter allows for data transmission between the multimeter and the PC.

#### METRAwin10 PC Evaluation Software (for METRAHIT ULTRA as of 2013)

METRAwin10 PC software is a multilingual, measurement data logging program for recording, visualizing, evaluating and documenting measured values from METRAHIT multimeters.

### 10.4.2 Bluetooth Interface

#### USB Bluetooth Adapter for PC

The following Bluetooth adapters for communication between METRAHIT ULTRA and PC have been successfully tested so far:

Belkin F8T016NG and LOGI LINK BT0007

Bluetooth adapters by other manufacturers should fulfill the following technical minimum requirements:

Bluetooth 2.1 + EDR, class 2

#### Terminal program for PC

Indication and evaluation of the measured values received via a Bluetooth adapter can be effected via a terminal program.

#### METRALOG App for Smartphone and Tablet PC

Provided you have a smartphone or tablet PC with Android operating system and Bluetooth interface, our METRALOG app in combination with the METRAHIT ULTRA BT TRMS Digital Multimeter offers the following functions:

- Indication of measured values received from the multimeter as: digital or analog values, measured value curve  $Y(t)$  and measured value logger
- Recording of measuring transactions
- Transmission of logs via wireless and network services
- Acoustic warning signal when radio contact is interrupted
- Trigger for exceeding/falling short of adjustable limit
- SMS and/or acoustic warning signal for trigger event

The METRALOG app can be obtained via the Google Play Store (see QR code on the right) and installed on your smartphone or tablet PC (Operating System minimum Android 2.3.3). **Attention:** For any errors in the software especially through interaction with other applications, any liability is excluded.



#### Short-form Instructions

- 1 Touch the app icon to start the program.
- 2 Select **METRAHIT ULTRA BT** from the list of receivable Bluetooth devices. The following message is displayed: „Bluetooth connection to measuring instrument being established“.
- 3 To establish the radio communication, enter the same pin you have already entered for the interface parameter **bt pin** of the multimeter, see section 7.2. When the connection has been successful, an analog display appears in which the following message is shown at the bottom right „Measurement in process“.
- 4 You can switch between digital display, measured value curve  $Y(t)$  and analog display in the bottom line on the left.
- 5 By touching the REC symbol, you can start or stop the recording of the measured values.
- 6 Touching the magnifier symbol in the bottom line on the right takes you to the measured value logger overview where you can select measuring intervals for graphic representation of for transmission.

11 Index

**A**

Addr ..... 57  
 APoFF ..... 51  
 App METRALOG ..... 71  
 Automatic Shutdown  
   Disabling ..... 17  
   Set Time ..... 17

**B**

bAtt ..... 50  
 Batteries  
   Charge Level ..... 13, 66  
   Periods of Non-Use ..... 66  
   Replacement ..... 67  
 bEEP ..... 52  
 bEEPEr on/off ..... 52  
 Bluetooth ..... 56  
 bt Pin ..... 57

**C**

Cable Resistance ..... 39  
 cALdAt ..... 50  
 Capacitance Measurement ..... 40  
 Com bt ..... 57  
 Com ir ..... 57  
 Continuity Test ..... 36  
 Current Clamp Sensor ..... 44, 45  
 Current Clamp Transformer ..... 46  
 Current Measurement  
   Notes ..... 41  
   Scope of Functions ..... 41

**D**

dAtE ..... 50, 51  
 Default Settings ..... 55  
 Device Disposal ..... 68  
 Diode Test ..... 37  
 Display Illumination ..... 16  
 Duty Cycle Measurement ..... 34

**E**

Error Messages ..... 66

**F**

Fuse  
   Characteristic Values ..... 63  
   Replacement ..... 67

**H**

HYSr ..... 53

**I**

Interfaces  
   Accessories ..... 71  
   select ..... 57  
   States ..... 13  
 irStb ..... 57  
 itEMP ..... 50

**M**

Maintenance  
   Housing ..... 68  
 Manufacturer's Guarantee ..... 69  
 Measurement Cables ..... 70

Measuring Categories

  Significance ..... 8  
 METRALOG App ..... 71

**N**

noFIL ..... 52

**O**

OCCUP ..... 50  
 Overview  
   Keys and Connections ..... 12  
   Parameters ..... 49

**P**

Power Pack  
   Accessories ..... 70  
   Adapter Socket Position ..... 15  
   Initial Start-Up ..... 16  
 Product Support ..... 3  
 Product Support Hotline ..... 3

**R**

rAtE ..... 53  
 Recalibration Service ..... 4, 69  
 Reference Junction ..... 38  
 Repair and Replacement Parts Service ..... 4  
 Resistance Measurement ..... 35

**S**

Safety Precautions ..... 8  
 Sampling Rate (rAtE parameter) ..... 53  
 Scope of Delivery ..... 2  
 Software Enabling ..... 3  
 Storage Speed (rAtE parameter) ..... 53



---

Switching On	
Manual .....	16
Via PC .....	16
Symbols	
Device .....	15
Digital Display .....	13
Rotary Switch Positions .....	14
<b>T</b>	
tEMP intErn/ExtErn .....	52
tEMP unit .....	52
Temperature Measurement	
With Resistance Sensors .....	39
With Thermocouples .....	38
Terminal program .....	71
tiME .....	50, 51
Transmission Speed (rAtE parameter) .....	53
triG .....	54
tStorE .....	54
<b>U</b>	
USB Bluetooth adapter for PC .....	71
Use for Intended Purpose .....	10
<b>V</b>	
vErSion .....	50
Voltage Comparator .....	32
Voltage Measurement	
Notes .....	28
Scope of Functions .....	28
<b>W</b>	
WEEE Mark .....	15

---

Edited in Germany • Subject to change without notice • PDF version available on the Internet

 **GOSSEN METRAWATT**  
GMC-I Messtechnik GmbH  
Südwestpark 15  
90449 Nuremberg • Germany

Phone: +49-911-8602-111  
Fax: +49-911-8602-777  
e-mail: [info@gossenmetrawatt.com](mailto:info@gossenmetrawatt.com)  
[www.gossenmetrawatt.com](http://www.gossenmetrawatt.com)