

METRAHIT | **T-COM PLUS**

Cable Multimeter for Measurements in Symmetrical Copper Cable Networks

3-349-560-03
7/8.17



Standard Equipment

- 1 Cable multimeter
- 1 Protective rubber cover
- 1 KS21-T cable set (1000 V CAT III) consisting of:
 - one 2-conductor measurement cable (yellow/blue), 2 meters long, with test probes,
 - 1 earth terminal cable (black), 2 meters long, with test probe
- 1 DAkkS calibration certificate with calibration report
- 2 Batteries, 1.5 V, type AA, installed
- 1 Condensed operating instructions *

* Detailed operating instructions are available for download on the Internet at www.gossenmetrawatt.com.

Accessories (sensors, plug inserts, adapters, consumable materials)

The accessories available for your instrument are checked for compliance with currently valid safety regulations at regular intervals, and are amended as required for new applications. Currently up-to-date accessories which are suitable for your measuring instrument are listed at the following web address along with photo, order number, description and, depending upon the scope of the respective accessory, data sheet and operating instructions:
www.gossenmetrawatt.com

See also chapter 11 on page 72.

Manufacturer

If required please contact:

GMC-I Messtechnik GmbH
Südwestpark 15
90449 Nürnberg, Germany

Product Support

If required please contact:

GMC-I Messtechnik GmbH

Product Support Hotline

Phone: +49 911 8602-0

Fax: +49 911 8602-709

e-mail support@gossenmetrawatt.com

Software Enabling for METRAWin 10

GMC-I Messtechnik GmbH

Front Office

Phone: +49 911 8602-111

Fax: +49 911 8602-777

e-mail: info@gossenmetrawatt.com

Standard Equipment – Contact Persons

Recalibration Service

We **calibrate** and **recalibrate** all instruments supplied by GMC-I Messtechnik GmbH, as well as other manufacturers, at our service center, for example after one year within the framework of your test equipment monitoring program, as well as prior to use etc. and offer you test equipment management free of charge.

Repair and Replacement Parts Service

Calibration Center* and Rental Instrument Service

If required please contact:

GMC-I Service GmbH
Service Center
Thomas-Mann-Str. 20
90471 Nuremberg, Germany
Phone: +49 911 817718-0
Fax: +49 911 817718-253
E-mail service@gossenmetrawatt.com
www.gmci-service.com

This address is only valid in Germany. Please contact our representatives or subsidiaries for service in other countries.

* DAkkS Calibration Laboratory for Measured Electrical Quantities
D-K-15080-01-01 accredited per DIN EN ISO/IEC 17025

Accredited quantities: direct voltage, direct current value, direct current resistance, alternating voltage, alternating current value, AC active power, AC apparent power, DC power, capacitance, frequency, temperature

Competent Partner

GMC-I Messtechnik GmbH is certified in accordance with DIN EN ISO 9001.

Our DAkkS calibration laboratory is accredited by the Deutsche Akkreditierungsstelle GmbH (National accreditation body for the Federal Republic of Germany) in accordance with DIN EN ISO/IEC 17025 under registration number D-K-15080-01-01.

We offer a complete range of expertise in the field of metrology: from **test reports** and **factory calibration certificates**, right on up to **DAkkS calibration certificates**.

Our spectrum of offerings is rounded out with free **test equipment management**.

As a full service calibration lab, we can calibrate instruments from other manufacturers as well.

Table of Contents

Contents	Page	Contents	Page
1 Safety Features and Precautions	8	5 Measurements	26
1.1 Use for Intended Purpose	10	5.1 Voltage Measurement	26
1.2 Meanings of Danger Symbols	10	5.1.1 Direct and Pulsating Voltage Measurement, V DC and V (DC+AC)	27
1.3 Meanings of Acoustic Warning Signals	10	5.1.2 Alternating Voltage and Frequency Measurement V AC and Hz with Selectable Low-Pass Filter	28
2 Operating Overview		5.2 Resistance Measurement, Ohm	30
– Connections, Keys, Rotary Switch, Symbols	12	5.3 Temperature Measurement – Temp RTD	31
3 Initial Start-Up	16	5.3.1 Measurement with Resistance Thermometers	31
3.1 Batteries	16	5.4 Continuity Test	33
3.2 Activation	16	5.5 Diode Testing with 1 mA Constant Current	34
3.3 Setting the Operating Parameters	16	5.6 Capacitance Measurement	35
3.4 Switching the Instrument Off	17	5.6.1 Cable Length Measurement m	35
4 Control Functions	18	5.7 Current Measurement	36
4.1 Selecting Measuring Functions and Measuring Ranges	18	5.7.1 Direct and Pulsating Current Measurement, Direct Connection, A DC and A (DC+AC)	37
4.1.1 Automatic Range Selection	18	5.7.2 Alternating Current and Frequency Measurement, Direct Connection, A AC and Hz	38
4.1.2 Manual Measuring Range Selection	18	5.7.3 Direct and Pulsating Current Measurement with Clip-On Current Sensor, A DC and A (DC+AC)	39
4.1.3 Quick Measurements	19	5.7.4 Alternating Current Measurement with Clip-On Current Sensor, A AC and Hz	40
4.2 Zero Offset / Relative Measurements	19		
4.3 Display (LCD)	20		
4.3.1 Digital Display	20		
4.3.2 Analog Display	20		
4.4 Measured Value Storage: DATA (auto-hold / compare)	21		
4.4.1 Saving Minimum and Maximum Values – MIN/MAX Function	22		
4.5 Measurement Data Recording	23		
		6 Measurements in Symmetrical Copper Cable Networks ..	42
		6.1 “R _{SL} ” Loop Impedance Measurement with 2 mA Constant Current	42
		6.2 Detection of Interference Voltages	43
		6.3 Insulation Resistance Measurement: in Telecommunications Networks – Ω ISO Function	43
		6.3.1 Connecting the Measurement Cables	44
		6.3.2 Selection of Test Voltage or Galvanic Signature	44
		6.3.3 Performing Insulation Resistance Measurements	45

Contents	Page	Contents	Page		
6.3.4	Ending the Measurement and Discharging	46	11 Accessories (Standard Equipment See Page 2)	72	
6.4	Interference-immune Capacitance Measurement in Telecommunications Networks – CAP Function	47	11.1	General	72
6.4.1	Cable Length Measurement	47	11.2	Technical Data for Measurement Cables (scope of delivery: KS21-T safety cable set)	72
6.5	Galvanic Signature Recognition in Selector Switch Positions a-b	49	11.3	Power Pack NA X-TRA	72
7	Device and Measuring Parameters	52	11.4	Interface Accessories	73
7.1	Paths to the Various Parameters	53	12	Index	74
7.2	List of All Parameters	53			
7.3	Querying Parameters – InFo Menu (as moving letters)	54			
7.4	Entering Parameters – SETUP Menu	54			
7.5	Default Settings	57			
8	Interface Operation	58			
8.1	Activating the Interface	58			
8.2	Configuring Interface Parameters	59			
9	Technical Data	60			
10	Maintenance and Calibration	68			
10.1	Displays – Error Messages	68			
10.2	Batteries	68			
10.3	Fuses	69			
10.4	Housing Maintenance	70			
10.5	Return and Environmentally Sound Disposal	70			
10.6	Recalibration	71			
10.7	Manufacturer's Guarantee	71			

1 Safety Features and Precautions

You have selected an instrument which provides you with a high level of safety.

This instrument fulfills the requirements of the applicable EU guidelines and national regulations. This is confirmed by means of the CE mark. A corresponding declaration of conformity can be requested from GMC-I Messtechnik GmbH.

The TRMS digital multimeter has been manufactured and tested in accordance with the following safety regulations: IEC 61010–1:2010 / DIN EN 61010–1:2011 / VDE 0411–1:2011. When used for its intended purpose (see page 10), safety of the operator, as well as that of the instrument, is assured. Their safety is however not guaranteed, if the instrument is used improperly or handled carelessly.

In order to maintain flawless technical safety conditions, and to assure safe use, it is imperative that you read the operating instructions thoroughly and carefully before placing your instrument into service, and that you follow all instructions contained therein.

Measuring Categories and their Significance per IEC 61010-1

CAT	Definition
I	Measurements in electrical circuits which are not directly connected to the mains: <i>e.g. electrical systems in motor vehicles and aircraft, batteries etc.</i>
II	Measurements in electrical circuits which are electrically connected to the low-voltage mains: <i>via plug, e.g. in household, office and laboratory applications</i>
III	Measurements in building installations: stationary consumers, distributor terminals, devices connected permanently to the distributor

The measuring category and the maximum rated voltage which are printed on the device apply to your measuring instrument, e.g. 600 V CAT II.

For the application of measuring cables see page 72.

Observe the following safety precautions:

- The multimeter may not be used in **potentially explosive atmospheres**.
- The multimeter may only be operated by persons who are capable of recognizing **contact hazards** and taking the appropriate safety precautions. Contact hazards according to the standards exist anywhere, where voltages of greater than 33 V RMS or 70 V DC may occur. Avoid working alone when taking measurements which involve contact hazards. Be certain that a second person is present.
- **Maximum allowable voltage** between the voltage measuring sockets or all connector sockets and ground is 600 V for measuring category II, and 300 V for measuring category III.
- Be prepared for the occurrence of unexpected voltages at devices under test (e.g. defective devices). For example, capacitors may be dangerously charged.

- Make certain that the measurement cables are in flawless condition, e.g. no damage to insulation, no interruptions in cables or plugs etc.
- No measurements may be made with this instrument in electrical circuits with corona discharge (high-voltage).
- Special care is required when measurements are made in HF electrical circuits. Dangerous pulsating voltages may be present.
- Measurements under moist ambient conditions are not permitted.
- Be absolutely certain that the measuring ranges are not overloaded beyond their allowable capacities. Limit values are included in chapter 9; "Technical Data" in the table entitled "Measuring Functions and Measuring Ranges" in the "Overload Capacity" column.
- **The multimeter may only be operated with installed batteries or rechargeable batteries. Dangerous currents and voltages are otherwise not indicated, and the instrument may be damaged.**
- The instrument may not be operated if the fuse cover or the battery compartment lid has been removed, or if its housing is open.
- The input for the current measuring range is equipped with a fuse link.
Maximum permissible voltage for the measuring circuit (= rated voltage of the fuse) is 600 V AC/DC.
Use specified fuses only (see page 64)! The fuse must have a **breaking capacity of at least 10 kA.**

Opening of Equipment / Repair

The equipment may be opened only by authorized service personnel to ensure the safe and correct operation of the equipment and to keep the warranty valid.

Even original spare parts may be installed only by authorized service personnel.

In case the equipment was opened by unauthorized personnel, no warranty regarding personal safety, measurement accuracy, conformity with applicable safety measures or any consequential damage is granted by the manufacturer.

Repair and Parts Replacement

When the instrument is opened, voltage conducting parts may be exposed. The instrument must be disconnected from the measuring circuit before the performance of repairs or the replacement of parts. If repair of a live open instrument is required, it may only be carried out by trained personnel who are familiar with the dangers involved.

Defects and Extraordinary Strains

If it may be assumed that the instrument can no longer be operated safely, it must be removed from service and secured against unintentional use.

Safe operation can no longer be relied upon:

- If the device demonstrates visible damage,
- If the instrument no longer functions, or if malfunctioning occurs,
- After long periods of storage under unfavorable conditions, e.g. humidity, dust or extreme temperature (see "Ambient Conditions" on page 64).

1.1 Use for Intended Purpose

- The respective multimeter is a portable device which can be held in the hand during the performance of measurements.
- Only those types of measurements described in chapter 5 may be performed with the measuring instrument.
- The measuring instrument, including measurement cables and plug-on test probes, may only be utilized within the specified measuring category (see page 64 and the table on page 8 regarding significance).
- Overload limits may not be exceeded. See technical data on page 60 for overload values and overload limits.
- Measurements may only be performed under the specified ambient conditions. See page 64 regarding operating temperature range and relative humidity.
- The measuring instrument may only be used in accordance with the specified degree of protection (IP code) (see page 66).

1.2 Meanings of Danger Symbols



Warning concerning a point of danger
(attention: observe documentation!)



Warning concerning dangerous voltage at the measurement input: $U > 15 \text{ V AC}$ or $U > 25 \text{ V DC}$

1.3 Meanings of Acoustic Warning Signals

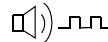

Voltage warning: $> 620 \text{ V}$ (intermittent acoustic signal)

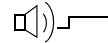

Current warning: $> 1.2 \text{ A}$ (continuous acoustic signal)

2 Operating Overview

– Connections, Keys, Rotary Switch, Symbols





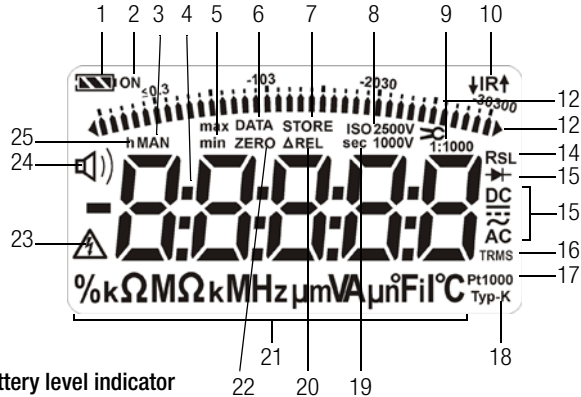

- 1 Display (LCD) (see page 13 for significance of symbols)
- 2 **MAN / AUTO** shift key for manual/automatic measuring range selection
 △ Increase parameter values / **MΩ ISO**: Test voltage 10 V/100 V/signature
 “Operating Mode” menu: Selection of individual menu entries against the direction of flow
- 3 **ON / OFF | LIGHT** key for switching device and display illumination on and off
- 4 **FUNC | ENTER** multifunction key
 “Operating Mode” menu: Acknowledge entry (ENTER)
Uiso ON / OFF Insulation resistance measurement
 Key for switching insulation resistance measurement on and off
- 5 ▷ Increase measuring range or move decimal point to the right (MAN function)
- 6 **Rotary switch** for measuring functions (see page 14 for significance of symbols)
- 7 DAKS calibration mark
- 8 Connector socket for ground / connected to ground
- 9 Connector socket for current measurement with automatic blocking
- 10 Connector socket for voltage, resistance, temperature, diode and capacitance measurement with automatic blocking
- 11 **DATA / MIN / MAX**
 Key for freezing, comparing, deleting the measured value, and for Min/Max function
 ▽ Decrease values / **MΩ ISO**: Test voltage 10 V/100 V/signature
 “Operating Mode” menu: Select individual menu entries in flow direction
- 12 **MEASURE | SETUP** Key for switching between measuring and menu functions
- 13 **ZERO | ESC**
 Key for zero balancing
 “Operating Mode” menu: Exit menu level and return to a higher level, exit parameters entry function without saving
- POL / Uiso CAP**: Insulation resistance measurement / CAP: Capacitance measurement
 Press and hold key to reverse the polarity of the cable under test; prerequisite: rotary switch set to **MΩ ISO (a-b)(a-E)(b-E)**
- 14 < Decrease measuring range or move decimal point to the left (MAN function)
- 15 Power pack connector jack
- 16 Infrared interface

Symbols used in the Digital Display



Battery level indicator

-  Battery full
-  Battery OK
-  Battery weak
-  Battery (almost) dead, $U < 1.8\text{ V}$

Interface indicator

-  Data transmission ↓ to / ↑ from the multimeter is active
- IR** IR interface in standby mode (ready to receive starting commands)

- 1 Battery level indicator
- 2 ON: continuous operation (automatic shutdown deactivated)
- 3 MAN: manual measuring range selection active
- 4 Digital display with decimal point and polarity display
- 5 max/min: Min/Max value storage
- 6 DATA: display memory, “freeze measured value”
- 7 STORE: memory mode active
- 8 ISO: insulation resistance measurement (if blinking active) / selected test voltage 10 V or 100 V
- 9 1: x current clip factor (transformation ratio)
- 10 IR: infrared interface display
- 11 Scale for analog display
- 12 Pointer for analog display (bar graph – pointer) depending upon setting in *SEtUP* menu for the *R.d*, *SP* parameter *triangle appears*: indicates overranging
- 13 R_{SL} : loop impedance measurement selected
- 14 Diode measurement selected
- 15 Selected type of current
- 16 TRMS measurement
- 17 Pt100(0): selected platinum resistance thermometer with automatic recognition of Pt100/Pt1000
- 18 No function
- 19 sec (seconds): unit of time
- 20 ΔREL: relative measurement with reference to offset
- 21 Unit of measure
- 22 ZERO: zero balancing active
- 23 Warning regarding dangerous voltage: $U > 15\text{ V AC}$ or $U > 25\text{ V DC}$**
- 24  Continuity test with acoustic signal active
- 25 h (hours): unit of time

Operating Overview – Connections, Keys, Rotary Switch, Symbols

Symbols used for Rotary Switch positions

Switch	FUNC	Display	Measuring Function
V~	0/4	V~ AC TRMS	Alternating voltage, AC TRMS, full bandwidth
Hz (V)	1	Hz ~ AC	Voltage frequency, full bandwidth
V~ 200 Hz	2	V Fil ~ AC TRMS	Alternating voltage, AC TRMS, with low pass filter (200 Hz)
Hz (V) 200 Hz	3	Hz Fil ~ AC	Voltage frequency, with low pass filter (200 Hz)
V---	0/2	V--- DC	Direct voltage
V $\overline{\sim}$	1	V $\overline{\sim}$ DC AC TRMS	Pulsating voltage, TRMS ($V_{ACDC} = \sqrt{V_{AC}^2 + V_{DC}^2}$)
R _{SL}	0/3	RPE Ω	Loop impedance measurement with acoustic signal where I is constant
$\square \updownarrow$	1	$\square \updownarrow$ Ω	Continuity test with acoustic signal
$\rightarrow \vdash$	2	$\rightarrow \vdash$ V--- DC	Diode voltage where I is constant
Ω	0/2	Ω	(DC) resistance
Temp. RTD	1	°C Pt 100/1000	Temperature with Pt 100 / Pt 1000 resistance thermometer
\dashv	0/2	nF	Capacitance
m (km)	1	m (km)	Cable length (via capacitive linear electric constant)
a-b, a-E, b-E	0/2	V	Extraneous voltage test
M $\Omega_{ISO}@10V/100V$	1	ISO 100 V / k Ω / M Ω	Insulation resistance measurement:
CAP	*	nF	Interference-immune capacitance measurement in selector switch positions (a-b)(a-E)(b-E)
A---	0/2	A--- DC	Direct current value
A $\overline{\sim}$	1	A $\overline{\sim}$ DC AC TRMS	Pulsating current amperage, AC DC TRMS
A~	0/2	A~ AC TRMS	Alternating current amperage, AC TRMS
Hz (A)	1	Hz ~ AC	Current frequency
\times A---	0/2	A--- DC \times	DC amperage with AC DC clip-on current sensor, 1 V:1/10/100/1000 A
\times A $\overline{\sim}$	1	A $\overline{\sim}$ DC AC TRMS \times	Pulsating current amperage, TRMS, with AC DC clip-on current sensor, see above
\times A~	0/2	A~ AC TRMS \times	Alternating current amperage, TRMS, with clip-on current sensor, see above
Hz (\times A)	1	Hz ~ AC \times	Current frequency with clip-on current sensor, see above

* POL / Uiso CAP:1

User Interface Symbols in the Following Chapters

- ▷ ... ▷ Scroll through main menu
- ▽ ... ▽ Scroll through submenu
- ◁ ▷ Select decimal point
- △ ▽ Increase/decrease value
- b nE* Submenu/parameter (7-segment font)
- Info** Main menu (7-segment font, boldface)

Symbols on the Device



Warning concerning a point of danger (attention: observe documentation!)



Ground

CAT II / III Measuring category II or III device, see also “Measuring Categories and their Significance per IEC 61010-1” on page 8.



Continuous, doubled or reinforced insulation



Indicates EC conformity



Position of the infrared interface, window on the top of the instrument



Position of the power pack adapter socket, see also chapter 3.1.



Fuse for current measuring ranges (see chapter 10.3)



The device may not be disposed of with the trash. Further information regarding the WEEE mark can be accessed on the Internet at www.gossenmetrawatt.com under the search term WEEE (see also chapter 10.5).

Calibration mark (blue seal):

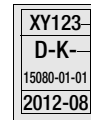

Serial number

D-K- German Accreditation Body GmbH – Calibration lab

15080-01-01 Registration number

2012-08 Date of calibration (year – month)

See also “Recalibration” on page 71.

3 Initial Start-Up

3.1 Batteries

Be certain to refer to chapter 10.2 regarding correct battery installation!

Momentary battery voltage can be queried in the “Info” menu (see chapter 7.3).



Attention!

Disconnect the instrument from the measuring circuit before opening the battery compartment lid in order to replace the batteries.

Operation with Power Pack (not included, see chapter 11.3) *

Installed batteries are disconnected electronically if the NA X-TRA power pack is used, and need not be removed from the instrument. If rechargeable batteries are used, they must be recharged externally.

If the external power supply is switched off, the device is switched to battery operation without interruption.

* for highly sensitive impedance measurements (R/C) we recommend battery operation

3.2 Activation

Switching the Instrument On Manually

- ⇨ Press the **ON / OFF | LIGHT** key until the display appears. Power-up is acknowledged with a brief acoustic signal. As long as the key is held depressed, all of the segments at the liquid crystal display (LCD) are illuminated. The LCD is depicted on page 13. The instrument is ready for use as soon as the key is released.

Display Illumination

After the instrument has been switched on, background illumination can be activated by briefly pressing the **ON / OFF | LIGHT** key. Illumination is switched back off by once again pressing the same key, or automatically after approximately 1 minute.

Switching the Instrument On with a PC

The multimeter is switched on after transmission of a data block from the PC, assuming the “*rSLB*” parameter has been set to “*rON*” (see chapter 7.4).

However, we recommend using the power saving mode: “*rOFF*”.



Note

Electrical discharge and high frequency interference may cause incorrect displays to appear, and may disable the measuring sequence.

Disconnect the device from the measuring circuit. Switch the instrument off and back on again in order to reset. If the problem persists, briefly dislodge the battery from the connector contacts (see also chapter 10.2).

3.3 Setting the Operating Parameters

Setting Time and Date

See “*T*”, “*DE*” and “*dALE*” parameters in chapter 7.4.

Display Modes for the Analog Display

Selection can be made from two different display modes (see “*R.d*”, “*SP*” parameter in chapter 7.4).

Display Modes for the Digital Display

Selection can be made from two different display modes (see “*D.d*”, “*SP*” parameter in chapter 7.4).

3.4 Switching the Instrument Off

Switching the Instrument Off Manually

- ⇨ Press the **ON / OFF | LIGHT** key until **OFF** appears at the display. Shutdown is acknowledged with a brief acoustic signal.

Automatic Shutdown

The instrument is switched off automatically if the measured value remains unchanged for a long period of time (maximum measured value fluctuation of approximately 0.8% of the measuring range per minute or 1° C or 1° F per minute), and if none of the keys or the rotary switch have been activated before a selected period of time in minutes has elapsed (see “**AP_{OFF}**” parameter on page 53). Shutdown is acknowledged with a brief acoustic signal.

Exceptions include:

Transmission and memory mode operation, continuous operation and whenever a dangerous voltage is applied to the input ($U > 15 \text{ V AC}$ or $U > 25 \text{ V DC}$).

Disabling Automatic Shutdown

The instrument can be set to continuous operation.

- ⇨ Simultaneously press the

 and  keys to this end.

The “Continuous On” function is indicated at by means of the **ON** display to the right of the battery symbol.

The “Continuous On” setting can only be cancelled by changing the respective parameter, and not by switching the instrument off (see “AP_{OFF}**” on page 55).**

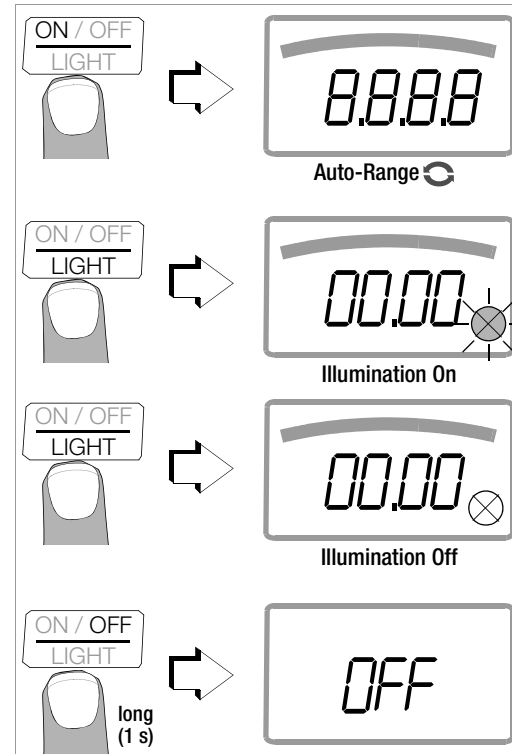

4 Control Functions

4.1 Selecting Measuring Functions and Measuring Ranges

4.1.1 Automatic Range Selection

The multimeter is equipped with auto-ranging for all measuring functions, except for temperature measurement, and diode and continuity testing. Auto-ranging is active as soon as the instrument is switched on. The instrument automatically selects the measuring range which allows for highest possible resolution of the applied quantity. When the instrument is switched to frequency measurement, the previously selected voltage measuring range remains active.

AUTO-Range Function

The multimeter is switched automatically to the next higher range at $\pm(3099 \text{ d} + 1 \text{ d} \rightarrow 03 \text{ 10 d})$, and to the next lower range at $\pm(200 \text{ d} - 1 \text{ d} \rightarrow 2799 \text{ d})$.

4.1.2 Manual Measuring Range Selection

Auto-ranging can be deactivated and measuring ranges can be selected manually in accordance with the following table by pressing the **MAN / AUTO** button.

The desired measuring range can then be selected with the \triangleleft or \triangleright key.

The instrument is automatically returned to range selection when the **MAN / AUTO** key is pressed, the rotary switch is activated or the instrument is switched off and back on again.

Overview: Auto-Ranging and Manual Range Selection

	Function	Display
MAN / AUTO	Manual mode active: utilized measuring range is fixed	MAN
\triangleleft or \triangleright	Range switching sequence for: V: 300 mV* \leftrightarrow 3 V \leftrightarrow 30 V \leftrightarrow 300 V \leftrightarrow 600 V Hz: 300 Hz \leftrightarrow 3 kHz \leftrightarrow 30 kHz \leftrightarrow 300 kHz (Hz(U)) Ω: 300 Ω \leftrightarrow 3 k Ω \leftrightarrow 30 k Ω \leftrightarrow 300 k Ω \leftrightarrow 3 M Ω \leftrightarrow 30 M Ω A: 300 μ A \leftrightarrow 3 mA \leftrightarrow 30 mA \leftrightarrow 300 mA \leftrightarrow 1 A A χ: See chapter 5.7.3 und chapter 5.7.4 F-H: 30 nF \leftrightarrow 300 nF \leftrightarrow 3 μ F \leftrightarrow 30 μ F \leftrightarrow 300 μ F MΩ_{ISO}: 300 k Ω \leftrightarrow 3 M Ω \leftrightarrow 30 M Ω \leftrightarrow 300 M Ω F CAP: 300 nF \leftrightarrow 3 μ F \leftrightarrow 10 μ F	MAN
MAN / AUTO	Return to automatic measuring range selection	—

* Via manual measuring range selection only

The multimeter is held in the selected measuring range. If the range limit is exceeded, **OL** appears at the display. You should then switch to the next higher measuring range with the help of the \triangleright key.

Measurement type M Ω_{ISO} : If the measured value is less than 10% of the measuring range after manual measuring range selection, **ur** (under range) appears at the display. You should then select the next smaller measuring range with the help of the \triangleleft key.

4.1.3 Quick Measurements

Measurements performed using a suitable fixed measuring range are executed more quickly than those which utilize automatic range selection. Quick measurement is made possible with the following two functions:

- **Manual measuring range selection**, i.e. selection of the measuring range with the best resolution (see chapter 4.1.2)

or

- With the **DATA function** (see chapter 4.4). In this way, the appropriate measuring range is selected automatically after the first measurement and the second measurement is executed more quickly.

The selected measuring range remains active for the subsequent series of measurements with these two functions.

4.2 Zero Offset / Relative Measurements

Zero balancing or a reference value for relative measurements can be stored to memory depending upon deviation from the zero point:

Deviation from zero – with short-circuited measurement cables for V, Ω , A – with open input for capacitance unit of measure: F	Display
0 to 200 digits	ZERO Δ REL
> 200 to 1500 digits	Δ REL

The relevant reference or correction value is deducted individually for the respective measuring function as an offset from all future measurements and remains in memory until deleted, or until the multimeter is switched off.

Zero balancing and reference value adjustment can be used for auto-ranging, as well as for manual measuring range selection.

Zero Balancing

- ⇨ Plug the measuring cables into the instrument and connect the free ends to each other, except for capacitance measurement in which case the ends of the cables are not connected to each other.
- ⇨ Briefly press the **ZERO | ESC** key.
The instrument acknowledges zero balancing with an acoustic signal, and the “ZERO Δ REL” symbol appears at the LCD. The value measured at the moment the key is pressed serves as a reference value.
- ⇨ Zero balancing can be cleared by once again pressing the **ZERO | ESC** key.



Note

As a result of TRMS measurement, the multimeter displays a residual value of 1 to 10/35 digits with short-circuited measurement cables as the zero point for V AC / I AC or V(AC+DC) / I (AC+DC) measurements (non-linearity of the TRMS converter). This has no influence on specified accuracy above 1% of the measuring range (or 10% in the mV ranges).

Setting the Reference Value

- ⇨ Plug the measuring cables into the instrument and measure a reference value (max. 1500 digits).

- ⇨ Briefly press the **ZERO | ESC** key.
The instrument acknowledges storage of the reference value with an acoustic signal, and the “ZERO ΔREL” or the “ΔREL” symbol appears at the LCD. The value measured at the moment the key is pressed serves as a reference value.
- ⇨ The reference value can be cleared by once again pressing the **ZERO | ESC** key.

Notes Regarding Relative Measurement

- Relative measurement effects the digital display only. The analog display continues to read out the original measured value.
- In the case of relative measurement, Ω F or AC quantities may also appear as negative values.

4.3 Display (LCD)

4.3.1 Digital Display

Measured Value, Unit of Measure, Type of Current, Polarity

The measured value with decimal and plus or minus sign appears at the digital display. The selected unit of measure and current type are displayed as well. A minus sign appears to the left of the value during the measurement of zero-frequency quantities, if the plus pole of the measured quantity is applied to the “ \perp ” input. The “ $\overline{D}, d, 5^P$ ” parameter can be used to determine whether leading zeros will be appear or be suppressed at the measured value display (see chapter 7.4).

Overranging

If the upper range limit of 3100 digits is exceeded “ \overline{OL} ” (overload) appears at the display.
Exceptions: “ \overline{OL} ” appears at the display as of 610.0 V in the case of voltage measurement in the 600 V range, as of 5100 digits for diode testing, and as of 1100 digits in the 1 A range.

4.3.2 Analog Display

Measured Value, Polarity

The analog display demonstrates the dynamic performance of a moving-coil mechanism. This display is especially advantageous for observing measured value fluctuation, and for balancing procedures.

Two different display modes can be selected in the “**SEtUP**” menu with the help of the “ $\overline{R}, d, 5^P$ ” parameter (see chapter 7.4):

- Bar graph
- Pointer: the current measured value is tracked in real-time

The analog scale displays a negative range of 5 scale divisions for the measurement of zero-frequency quantities, allowing for precise observation of measured value fluctuation around zero. If the measured value exceeds the negative range of 5 scale divisions, polarity is reversed at the analog display.

Scaling of the analog scale is automatic. This is very helpful for manual measuring range selection.

Overranging

Overranging in the positive range is displayed by means of the right triangle symbol.

Refresh Rate

In the bar graph and pointer modes, the analog display is refreshed 40 times per second.

4.4 Measured Value Storage: DATA (auto-hold / compare)

An individual measured value can be automatically “frozen” with the DATA function (auto-hold). This is useful, for example, when contacting the measuring points with the test probes requires your full attention. After the measuring signal has been applied and the measured value has settled in accordance with the “condition” listed in the table below, the measured value is frozen at the digital display and an acoustic signal is generated. The test probes can now be removed from the measuring points, and the measured value can be read from the digital display. If the measuring signal falls below the value specified in the table, the function is reactivated for storage of the next value.

Measured Value Comparison (DATA Compare)

If the currently frozen value deviates from the first saved value by less than 100 digits, the acoustic signal is generated twice. If deviation is greater than 100 digits, only one brief acoustic signal is generated.



Note

The DATA function has no effect on the analog display, at which the current measured value continues to appear. However, when the digital display is “frozen”, the decimal point is fixed as well (fixed measuring range, symbol: MAN). The selected measuring range should not be manually changed as long as the DATA function is active.

The DATA function is deactivated by pressing and holding the **DATA/MIN/MAX** key (approx. 1 second), when the measuring function is changed or when the instrument is switched off and back on again.

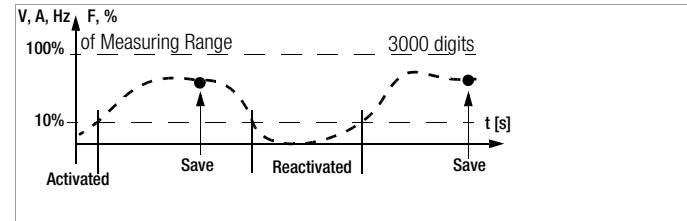

DATA Function	Press DATA / Min/Max	Condition		Response from Instrument		
		Measuring Function	Measuring Signal	MV Digital	DATA	Acoustic
Activate	Brief				Blinks	Once
Save (stabilized measured value)		V, A, F, Hz, %	> 10% of R	Is displayed	Static	Once Twice ²⁾
		Ω	$\neq \Omega_L$			
Reactivate ¹⁾		V, A, F, Hz, %	< 10% of R	Stored MV	Blinks	
		Ω	$= \Omega_L$			
Change to Min/Max	brief	See table in chapter 4.4.1				
Exit	long			Is cleared	Is cleared	Twice

¹⁾ Reactivation results from falling short of specified measured value limits.

²⁾ Two acoustic signals are generated the first time a measured value is saved as a reference value. For subsequent data hold, two acoustic signals are only generated if the currently frozen value deviates from the **first** saved value by less than 100 digits.

Key: MV = measured value, R = measuring range

Example

The voltage measuring range is set manually to 30 V. The first measured value is 5 V and is stored to memory because it is greater than 10% of the measuring range (= 3 V), and is thus reliable above the background noise level. As soon as the measured values drops to less than 10% of the measuring range, i.e. amounts to less than 3 V which corresponds to removal of the test probes from the measuring point, the instrument is ready to store a new value.

4.4.1 Saving Minimum and Maximum Values – MIN/MAX Function

Minimum and maximum measured values applied to the measuring instrument's input after the Min/Max function has been activated can be "frozen" at the display. The most important use of this function is the determination of minimum and maximum values during long-term measured value observation.

The Min/Max function can be activated in all measuring functions. The Min/Max function has no effect on the analog display, at which the current measured value continues to appear.

Apply the measured quantity to the instrument and set the measuring range with the **MAN / AUTO** key before activating the Min/Max function.

The Min/Max function is deactivated by pressing and holding the **DATA/MIN/MAX** key (approx. 1 second), when the measuring function is changed or when the instrument is switched off and back on again.

Function Min/Max	Press DATA / Min/Max	Min. and Max. Measured Values	Response from Instrument		
			Measured Value Digital	Max. Min.	Acoustic Signal
1 Activate and save	2 x brief	Are saved	Current measured value	Max and min	Twice
2 Save and display	Brief	Storage continues in background, new min. and max. values are displayed.	Saved min. value	Min.	Once
	Brief		Saved max. value	Max.	Once
3 Return to 1	Brief	Same as 1, stored values are not deleted	Same as 1	Same as 1	Once
Stop	Long	Are deleted	Current measured value	Is deleted	Twice



Note

As opposed to the DATA function, the Min/Max function can also be used for temperature measurement.

4.5 Measurement Data Recording

The cable multimeter is capable of recording measurement data using an adjustable sampling rate for long periods of time in the form of measurement series. Data are stored to a battery-backed memory module, and are retained even after the multimeter is switched off. The system acquires measured values relative to real-time.

Stored measured values can subsequently be read out with the help of **METRAwin 10** software. The only prerequisite is a PC which is connected by means of an interface cable to the USB | **X-TRA** bidirectional interface adapter, which is plugged onto a cable multimeter. See also chapter 8, "Interface Operation".

Memory Parameters Overview

Parameter	Page: Header
<i>CLEAR</i>	24: Clear Memory
<i>EMPTY</i>	24: Clear Memory – appears after <i>CLEAR</i>
<i>OCCUP</i>	24: Querying Memory Occupancy
<i>rAtE</i>	54: rAtE – set the sampling rate
<i>StArT</i>	23: Starting Recording via Menu Functions
<i>StoP</i>	24: Ending Recording

The STORE Menu Function

- First set the **sampling rate** for memory mode operation (see chapter 7.4 the *rAtE* parameter) , and then start memory mode operation.
- First select the desired measuring function and an appropriate measuring range.
- Check the battery charge level before starting long-term measurement recordings (see chapter 7.3). Connect the NA X-TRA power pack if required.

Starting Recording via Menu Functions

- Switch to the "**StoP**" mode by pressing **MEASURE | SETUP**, and select the "**StoP**" menu.



- Memory mode operation is started by activating **FUNC | ENTER**. **STORE** appears underneath the analog display and indicates that the memory mode has been activated. "**StoP**" appears at the digital display.
- Press **MEASURE | SETUP** in order to return to the measuring function.

Control Functions

During Recording

STORE is displayed underneath the analog display during memory mode operation, and **memory occupancy** can be monitored:

StoP ▷ 000.3%

The following message appears as soon as memory is full: “100.0%”.

In order to be able to **observe measured values during recording**, switch to the measuring function by pressing **MEASURE | SETUP**. The display is returned to the memory menu after once again pressing **MEASURE | SETUP**.

A new memory block is created when another measuring function is selected with the rotary switch or the **FUNC | ENTER** key. Data storage then continues automatically.

Ending Recording

⇨ “StoP” appears at the display after pressing **MEASURE | SETUP**.

StoP  Start

- ⇨ Acknowledge the “StoP” display by pressing **FUNC | ENTER**. STORE is cleared from the display indicating that recording has been ended.
- ⇨ Press **MEASURE | SETUP** in order to return to the measuring function.
- ⇨ Memory mode operation can also be exited by switching the multimeter off.

Querying Memory Occupancy

Memory occupancy can be queried during recording with the help of the “Info” menu (see also chapter 7.3).

Memory occupancy range: 000.1% to 099.9%.



 Info  batt: ▽ ... ▽ OCCUP %: 0 17.4 %

Memory occupancy can be queried before recording is started via the “Store” menu.

 Info ▷ ... ▷ Store  0 17.4 % ▷ Start

Clear Memory

This function deletes all measured values from memory! This function cannot be executed during memory mode operation.

 Info ▷ ... ▷ Store  0 17.4 % ▷ Start
▷ CLEAR  Empty

5 Measurements

5.1 Voltage Measurement

Notes Regarding Voltage Measurement

- The multimeter may only be operated with the batteries installed. Dangerous voltages are otherwise not indicated, and the instrument may be damaged.
- The multimeter may only be operated by persons who are capable of recognizing **contact hazards** and taking the appropriate safety precautions. Contact hazards exist anywhere, where voltages of greater than 33 V RMS may occur.
The test probes may only be only gripped up to the finger guard. Do not touch the metallic test probes under any circumstances.
- Avoid working alone when taking measurements which involve **contact hazards**. Be certain that a second person is present.
- **Maximum allowable voltage** between terminals 9 or 10 and ground (8) is 600 V for measuring category II, and 300 V for measuring category III.
- Be prepared for the occurrence of unexpected voltages at devices under test (e.g. defective devices). For example, capacitors may be dangerously charged.
- No measurements may be made with this instrument in electrical circuits with corona discharge (high-voltage).
- Special care is required when measurements are made in HF electrical circuits. Dangerous pulsating voltages may be present.

- Be aware of the fact that dangerous voltage spikes are not displayed during measurement with the low-pass filter.
We recommend measuring voltage without the low-pass filter first, in order to be able to detect any dangerous voltages.
- Be absolutely certain that the measuring ranges are not overloaded beyond their allowable capacities. Limit values are included in chapter 9, “Technical Data”, in the table entitled “Measuring Functions and Measuring Ranges” in the “Overload Capacity” column.

5.1.1 Direct and Pulsating Voltage Measurement, V DC and V (DC+AC)

- Set the CL, P parameter to **OFF** in the current clip setup menu. Otherwise all measured values are displayed in amperes, and are corrected by the amount resulting from the selected transformation ratio for an interconnected clip-on current sensor.



- In accordance with the voltage to be measured, turn the rotary switch to V_{DC} or V_{AC} .
- Connect the measurement cables as shown. The “⊥” connector jack should be grounded.

Note

An intermittent acoustic signal warns the operator if the measured value exceeds the upper range limit in the 600 V range.

Make sure that a current measuring range (“A”) has **not** been activated when the multimeter is connected for voltage measurement! If the fuse’s blowing limits are exceeded as a result of operator error, both the operator and the instrument are in danger!

With the rotary switch in the V position, the multimeter is always in the 3 V measuring range immediately after it is switched on. As soon as the **MAN / AUTO** key is pressed, and assuming the measured value is less than 280 mV, the multimeter is switched to the mV measuring range.

Measuring ranges:
 V_{DC} : 100 μ V...610 V
 V_{AC} : 10 mV...610 V
5 ranges: 300 mV, 3 V, 30 V, 300 V and 600 V
Max. 600 V 1 kHz
 Hz: 1 Hz ... 300 kHz
 $P_{max} = 6 \times 10^6 \text{ V} \times \text{Hz}$

Warnings regarding dangerous voltage:
 > 15 V AC or > 25 V DC:
 > 620 V:

5.1.2 Alternating Voltage and Frequency Measurement V AC and Hz with Selectable Low-Pass Filter

- ⇨ Set the CL, P parameter to **OFF** in the current clip setup menu. Otherwise all measured values are displayed in amperes, and are corrected by the amount resulting from the selected transformation ratio for an interconnected clip-on current sensor.



- ⇨ In accordance with the voltage or frequency to be measured, turn the rotary switch to V~ or Hz.
- ⇨ Connect the measurement cables as shown. The “ \perp ” connector jack should be grounded.

Voltage Measurement



Note

An intermittent acoustic signal warns the operator if the measured value exceeds the upper range limit in the 600 V range.

Make sure that a current measuring range (“A”) has not been activated, when the multimeter is connected for voltage measurement! If the fuse’s blowing limits are exceeded as a result of operator error, both the operator and the instrument are in danger!

- ⇨ You can switch back and forth between voltage measurement with and without low-pass filter.
- ⇨ Repeatedly press the **FUNC | ENTER** multifunction key, until the V or V/Fil unit of measure appears at the display.

Frequency Measurement

- ⇨ Apply the measured quantity is the same way as for voltage measurement.
- ⇨ Manually select the measuring range for the voltage amplitude. When the instrument is switched to frequency measurement, the previously selected voltage measuring range remains active.
- ⇨ You can switch back and forth between frequency measurement with and without low-pass filter. Repeatedly press the **FUNC | ENTER** multifunction key, until the Hz or Hz/Fil unit of measure appears at the display. Lowest measurable frequencies and maximum allowable voltages are included in chapter 9, “Technical Data”.

Measurement with Low-Pass Filter



Attention!

Be aware of the fact that dangerous voltage spikes are not displayed during this type of measurement (see also “Voltage Comparator”).

We recommend measuring voltage without the low-pass filter first, in order to be able to detect any dangerous voltages.

A 200 Hz low-pass filter can be activated if required, in order to filter out capacitively induced high frequency pulses of greater than 200 Hz, for example when performing measurements at cables, i.e. undesired voltages of greater than 200 Hz can be suppressed.

An active low-pass filter is indicated by the Fil display. The multimeter is automatically switched to manual measuring range selection.

Specified measuring accuracy is not reached with signals of greater than 100 Hz when the filter is active.

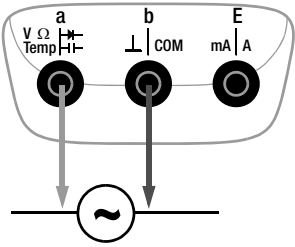

Measuring ranges:
 V~: 10 mV...610 V
 5 ranges: 300 mV, 3 V, 30 V, 300 V and 600 V

Max. 600 V 1 kHz
 Hz: 1 Hz ... 300 kHz
 $P_{max} = 6 \times 10^6 \text{ V} \times \text{Hz}$

Warnings regarding dangerous voltage:

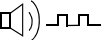
- > 15 V AC or > 25 V DC: 
- > 620 V: 

Voltage Comparator for Displaying Dangerous Voltage

The input signal or measuring signal is checked by a voltage comparator for dangerous spikes, because these do not appear at the display when the low-pass filter is used. At voltages of greater than 15 V AC or 25 V DC, a danger symbol appears at the display: .

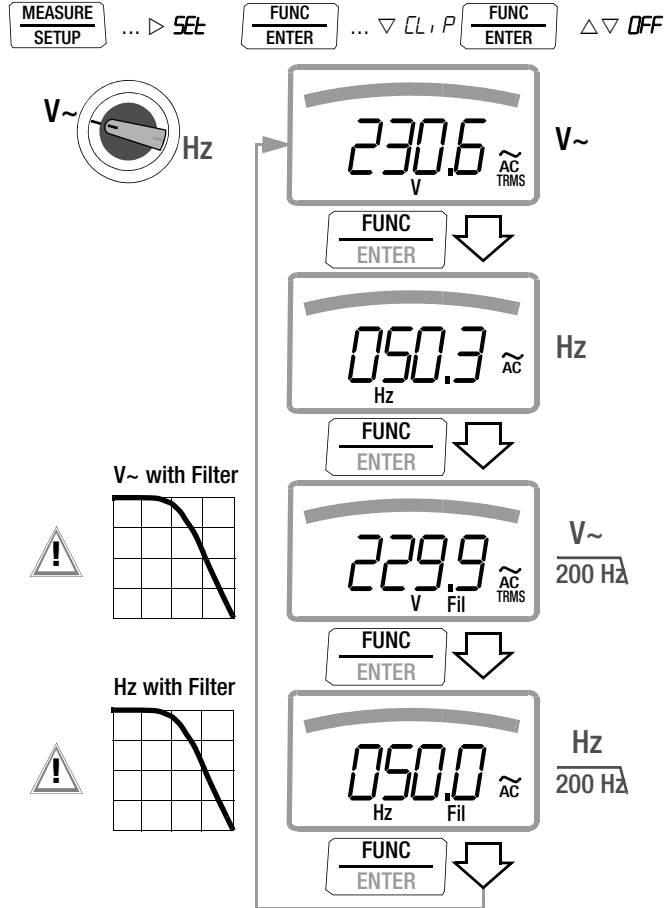

MEASURE SETUP ... ▷ *Set* FUNC ENTER ... ▾ *CL, P* FUNC ENTER Δ ▽ OFF

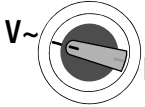
V~  Hz 230.6 _V [~] AC TRMS

FUNC ENTER ↓

Hz 050.3 _{Hz} [~] AC

FUNC ENTER ↓

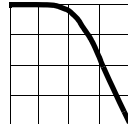
V~ with Filter  229.9 _V [~] AC TRMS _{Fil} 200 Hz

FUNC ENTER ↓

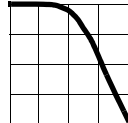
Hz with Filter  050.0 _{Hz} [~] AC _{Fil} 200 Hz

FUNC ENTER ↓

5.2 Resistance Measurement, Ohm

- ⇨ Disconnect supply power from the electrical circuit of the device to be measured, and discharge all high-voltage capacitors.
- ⇨ Make sure that the device under test is voltage-free. Interference voltages distort measurement results! Refer to chapter 5.1.1 regarding testing for the absence of voltage with the help of the direct voltage measurement.
- ⇨ Set the rotary switch to “ Ω ”.
- ⇨ Connect the device under test as shown.



Note

Use short or shielded measurement cables in the case of high-impedance resistance.



Note

Resistance measurement „ Ω “ is not suitable for measurements in symmetrical copper cable networks. Use the loop impedance measurement function instead, see chapter 6.1.

Improving Accuracy by means of Zero Balancing

Cable resistance and contact resistance can be eliminated in all measuring ranges by means of zero balancing (see chapter 4.2).

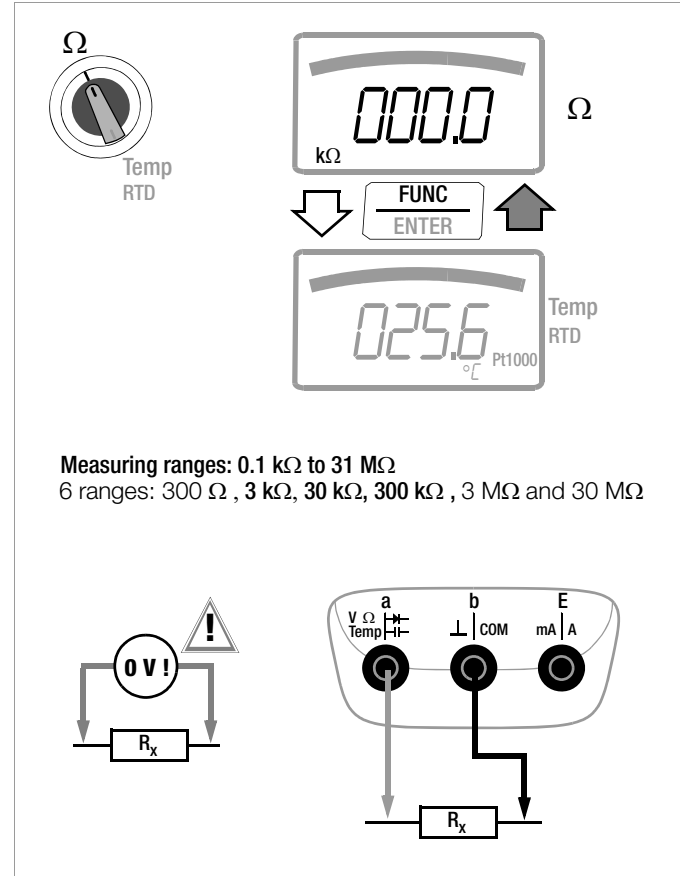

5.3 Temperature Measurement – Temp RTD

Temperature measurement is performed with a Pt100 or Pt1000 resistance thermometer (accessory, not included), which is connected to the voltage input.

Selecting the Unit of Measure for Temperature

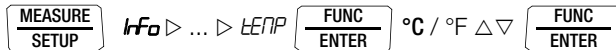

($^{\circ}\text{C}$ = default setting)

5.3.1 Measurement with Resistance Thermometers

⇒ Set the rotary switch to “ Ω ” or “Temp_{RTD}”.

Press the **FUNC | ENTER** key in order to change to the other measuring function if required.

The sensor type, i.e. Pt100 or Pt1000, is detected automatically and displayed.

There are two different ways to compensate for cable resistance:

Automatic Compensation

⇒ Acknowledge by pressing the **ZERO | ESC** key.
“Short leads” appears at the display.

If you prefer to enter cable resistance directly, you can skip the following entry prompt.

⇒ Short circuit the measuring instrument’s connector cables.
“000.0” appears at the display. After pressing the **FUNC | ENTER** key, automatic compensation of cable resistance is activated for all subsequent measurements.
The short-circuit can now be eliminated, and the device is ready for use.

Enter Cable Resistance

⇒ Press the **ZERO | ESC** key once again in the automatic compensation menu.

⇒ Enter the known resistance of the connector cables with the scroll keys:
Select the digit to be changed with the $\triangleleft \triangleright$ keys, and change the respectively selected digit with the $\nabla \triangle$ keys. The default value is 0.43 Ω . Values can be selected within a range of 0 to 50 Ω .

⇒ Upon pressing the **FUNC | ENTER** key, the selected value is activated and the display is returned to the measuring function.
Cable resistance remains in memory even after the instrument has been switched off.

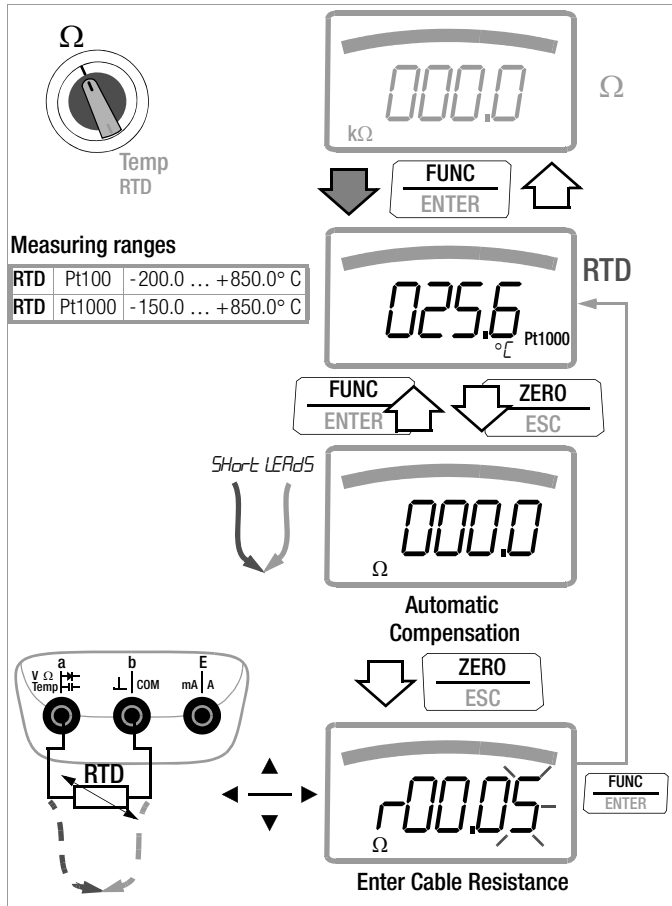

5.4 Continuity Test \square)

- Disconnect supply power from the electrical circuit of the device to be measured, and discharge all high-voltage capacitors.
- Make sure that the device under test is voltage-free. Interference voltages distort measurement results!
- Set the rotary switch to “R_{SL}” or “ \square)”.
- Briefly press the yellow multifunction key **FUNC | ENTER**. A loudspeaker symbol appears at the display.
- Connect the conductor path under test as shown.

Depending upon the selected limit value, the multimeter generates a continuous acoustic signal in the case of continuity or short-circuiting, i.e. at a value of less than the selected limit value. “OL” appears at the display in the case of an open connection. The limit value can be adjusted in the “**SEtP**” menu (see also chapter 7.4):

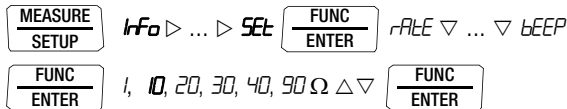

(10 = default setting)

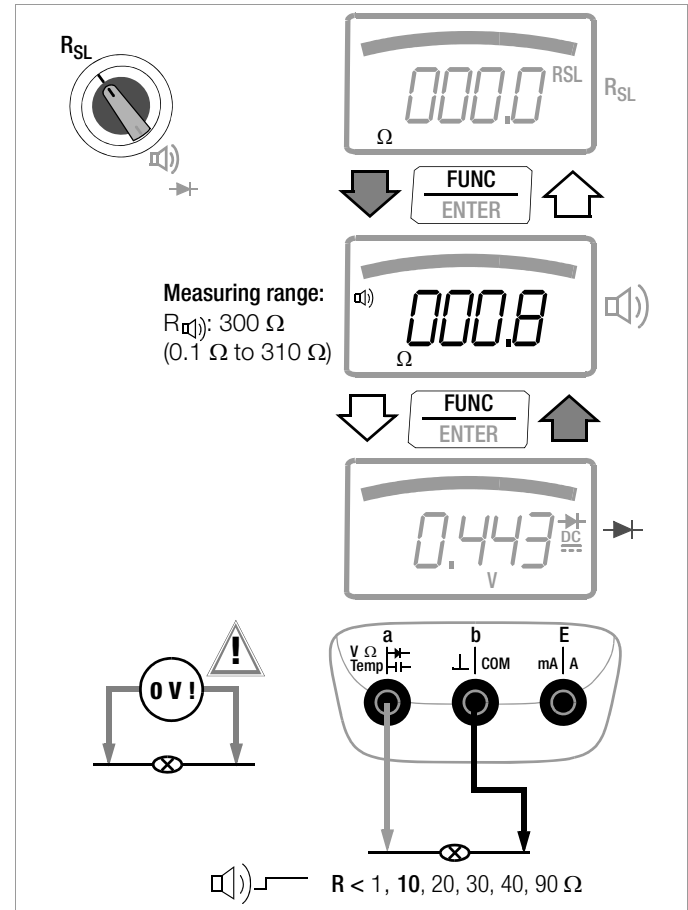

5.5 Diode Testing \rightarrow with 1 mA Constant Current

- ⇨ Disconnect supply power from the electrical circuit of the device to be measured, and discharge all high-voltage capacitors.
- ⇨ Make sure that the device under test is voltage-free. Interference voltages distort measurement results! Refer to chapter 5.1.1 regarding testing for the absence of voltage with the help of the direct voltage measurement.
- ⇨ Set the rotary switch to “R_{SL}” or “ \square)”.
- ⇨ Repeatedly press the **FUNC | ENTER** key until the diode symbol appears at the display.
- ⇨ Connect the device under test as shown.

Conducting Direction and Short-Circuit

The instrument displays the conducting-state voltage in volts (display: 4 places). As long as voltage drop does not exceed the maximum display value of 5.1 V, several series connected components or reference diodes can be tested with a small reference voltage and Zener diodes.

Reverse Direction and Interruption

The measuring instrument indicates overload **OL**.

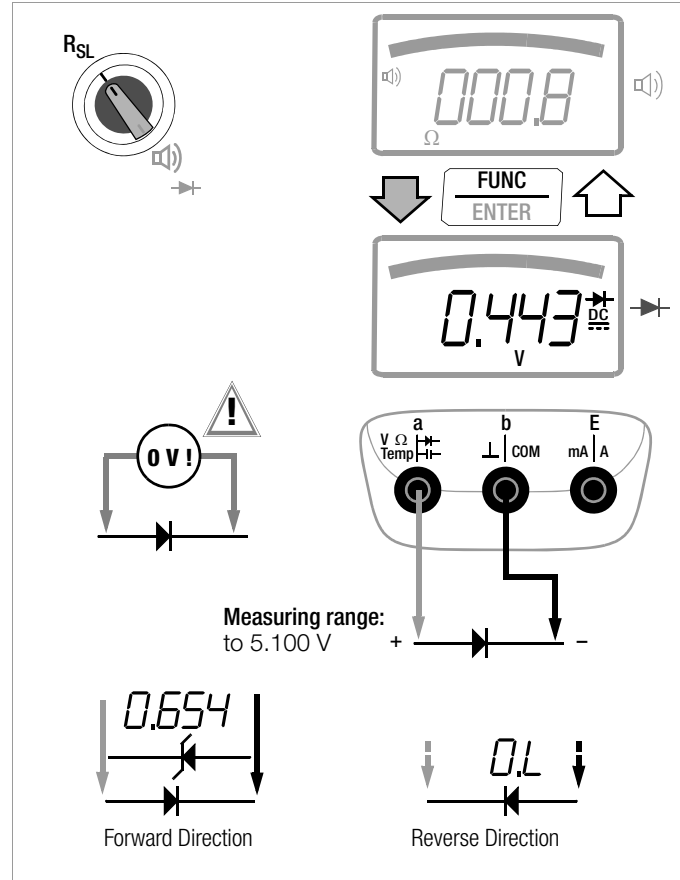

Note

Resistors and semiconductor paths connected in parallel to the diode distort measurement results!

5.6 Capacitance Measurement

- ◇ Disconnect supply power from the electrical circuit of the device to be measured, and discharge all high-voltage capacitors.
- ◇ Make sure that the device under test is voltage-free. Capacitors must always be discharged before measurement is performed.
Interference voltages distort measurement results!
Refer to chapter 5.1.1 regarding testing for the absence of voltage with the help of the direct voltage measurement.
- ◇ Set the rotary switch to “”.
- ◇ Connect the (discharged!) device under test to the sockets with the measurement cables as shown.



Note

The “-” pole of polarized capacitors must be connected to the “⊥” jack.
Resistors and semiconductor paths connected in parallel to the capacitor distort measurement results!



Note

This function is to be used especially for the measurement of components. For telecommunications networks, the special capacitance measurement is recommended, see chapter 6.4

5.6.1 Cable Length Measurement m

In the cable length measuring mode, the instrument calculates length as a function of the capacitance value entered by the user:

$$\text{Length (km)} = \frac{\text{measured capacitance (nF)}}{\text{capacitance value (nF / km)}}$$

Preparation and execution of this measurement is the same as for capacitance measurement.

- ◇ Press the yellow multifunction key **FUNC | ENTER**.
“k” and “m” (i.e. kilometers) appear at the display instead of “F”.

Refer to chapter 7.4 with regard to adjusting the “CAP” scaling factor (capacitive linear electric constant).



Note

When measuring cable length, make sure that the cable parameters (e.g. cross-section) are identical. Varying cable parameters, for example interconnected cables of **varying type or cross-section**, distort measurement results.



Note

This function is to be used especially for the measurement of components. For telecommunications networks, the special cable length measurement is recommended, see chapter 6.4.1

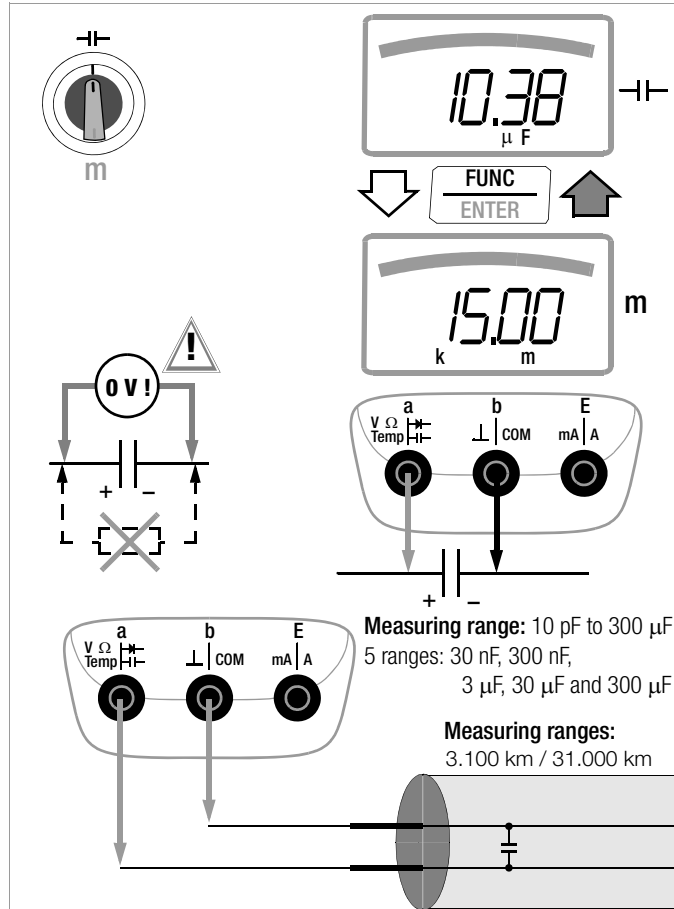

5.7 Current Measurement

Notes Regarding Current Measurement

- The multimeter may only be operated with installed batteries or rechargeable batteries. Dangerous currents are otherwise not indicated, and the instrument may be damaged.
- Set up the measuring circuit in a mechanically secure fashion, and secure it against inadvertent breaks. Select conductor cross-sections and lay out connections such that they do not overheat.
- A continuous acoustic signal warns of current greater than 1.2 A.
- The input for the current measuring range is equipped with a fuse link. Maximum permissible voltage for the measuring circuit (= rated voltage of the fuse) is 600 V AC/DC. Use specified fuses only! The fuse must have a **breaking capacity of at least 10 kA**.
- If the fuse for the active current measuring range blows, “FUSE” appears at the digital display, and an acoustic signal is generated at the same time.
- If a fuse should blow, eliminate the cause of overload before placing the instrument back into service!
- Fuse replacement is described in chapter 10.3.
- Be absolutely certain that the measuring ranges are not overloaded beyond their allowable capacities. Limit values are included in chapter 9, “Technical Data”, in the table entitled “Measuring Functions and Measuring Ranges” in the “Overload Capacity” column.

5.7.1 Direct and Pulsating Current Measurement, Direct Connection, A DC and A (DC+AC)

- First disconnect supply power from the measuring circuit or the power consumer (1), and discharge any capacitors.
- In accordance with the current to be measured, set the rotary switch to A $\overline{=}$ or A $\overline{\approx}$.
- Select the type of current appropriate for the measured quantity by briefly pressing the **FUNC | ENTER** multifunction key. Each time the key is pressed, the instrument is switched back and forth between A DC and A (DC + AC)_{TRMS}, which is indicated by means of an acoustic signal. The current type is indicated at the LCD by means of the DC or the (DC+AC)_{TRMS} symbol.
- Safely connect the measuring instrument (without contact resistance) in series to the power consumer (2) as shown.
- Switch supply power to the measuring circuit back on (3).
- Read the display. Make a note of the measured value if the instrument is not being operated in the memory mode or the transmission mode.
- Disconnect supply power from the measuring circuit or the power consumer (1) once again, and discharge any capacitors.
- Remove the test probes from the measuring point and return the measuring circuit to its normal condition.

Measuring ranges:
 A $\overline{=}$: 0.1 μ A ... 1.1 A
 A $\overline{\approx}$: 3 μ A ... 1.1 A
5 ranges: 300 μ A, 3 mA, 30 mA, 300 mA and 1 A

Warning: $I > 1.2$ A

5.7.2 Alternating Current and Frequency Measurement, Direct Connection, A AC and Hz

- First disconnect supply power from the measuring circuit or the power consumer (1), and discharge any capacitors.
- In accordance with the current or frequency to be measured, turn the rotary switch to A~ or Hz.
- Select the desired measured quantity by briefly pressing the **FUNC | ENTER** multifunction key. Each time the key is pressed, AC_{TRMS} and Hz are alternately selected, and switching is acknowledged with an acoustic signal.
- Safely connect the measuring instrument (without contact resistance) in series to the power consumer as shown.
- Switch supply power to the measuring circuit back on (3).
- Read the display. Make a note of the measured value if the instrument is not being operated in the memory mode or the transmission mode.
- Disconnect supply power from the measuring circuit or the power consumer (1) once again, and discharge any capacitors.
- Remove the test probes from the measuring point and return the measuring circuit to its normal condition.

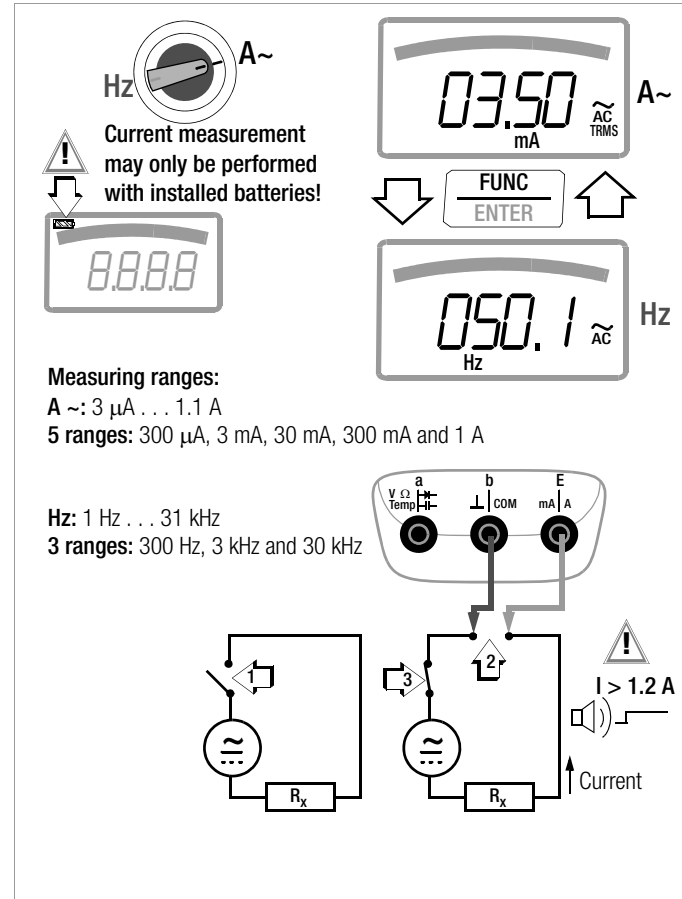

5.7.3 Direct and Pulsating Current Measurement with Clip-On Current Sensor, A DC and A (DC+AC)

Transformer Output, Voltage/Current

When a clip-on current sensor is connected to the multimeter (V input), all current displays appear with the correct value in accordance with the selected transformation ratio. The only prerequisite is that the current sensor is equipped with at least one of the below listed transformation ratios, and that the ratio has been previously selected in the following menu ($CL, P \neq OFF$) (see also chapter 7.4).

Current Clip Setup Menu

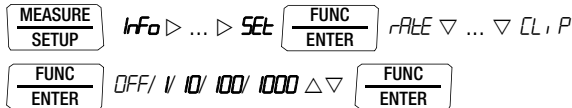

Trans. Ratio CL, P	Measuring Ranges			Clip Type
	300 mV	3 V	30 V	
1:1 1 mV / 1 mA	300.0 mA	3.000 A	30.00 A	WZ12C
1:10 1m V / 10 mA	3.000 A	30.00 A	300.0 A	WZ12B, Z201A/B, METRAFLEX
1:100 1m V / 100 mA	30.00 A	300.0 A	3,000 kA	Z202A/B, METRAFLEX
1:1000 1 mV/1 A	300.0 A	3,000 kA	30.00 kA	Z202A/B, Z203A/B, WZ12C, METRAFLEX

Maximum allowable operating voltage is equal to the current transformer's nominal voltage. When reading the measured value, additional error resulting from the clip-on current sensor must also be

taken into consideration (default value: $CL, P = OFF$ = voltage display).

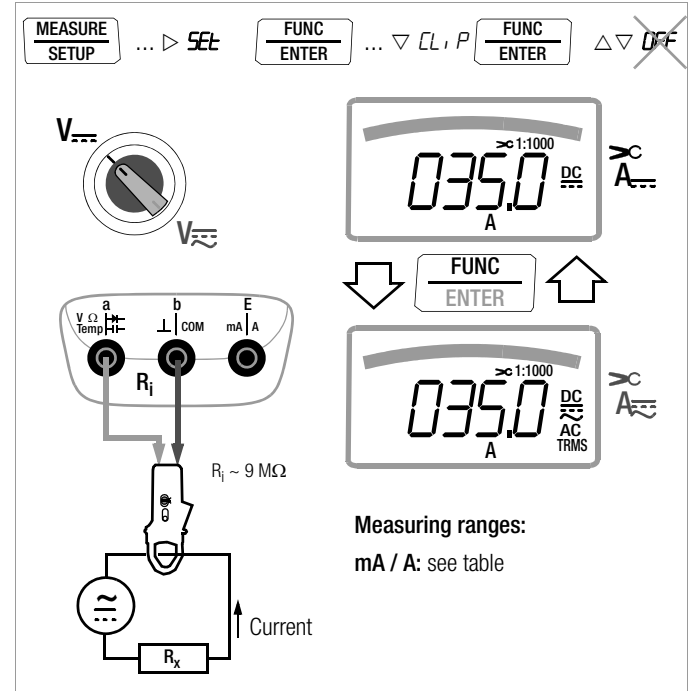

5.7.4 Alternating Current Measurement with Clip-On Current Sensor, A AC and Hz

Transformer Output, Voltage/Current

When a clip-on current sensor is connected to the multimeter (V input), all current displays appear with the correct value in accordance with the selected transformation ratio. The only prerequisite is that the current sensor is equipped with at least one of the below listed transformation ratios, and that the ratio has been previously selected in the following menu (**CL, P** \neq **OFF**) (see also chapter 7.4).

Current Clip Setup Menu

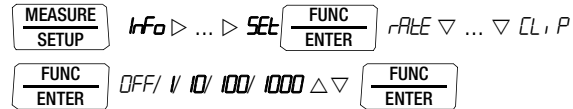

Trans. Ratio CL, P	Measuring Ranges			Clip Type
	300 mV	3 V	30 V	
1:1 1 mV / 1 mA	300.0 mA	3.000 A	30.00 A	WZ12C
1:10 1m V / 10 mA	3.000 A	30.00 A	300.0 A	WZ12B, Z201A/B, METRAFLEX
1:100 1m V / 100 mA	30.00 A	300.0 A	3,000 kA	Z202A/B, METRAFLEX
1:1000 1 mV/1 A	300.0 A	3,000 kA	30.00 kA	Z202A/B, Z203A/B, WZ12C, METRAFLEX

Maximum allowable operating voltage is equal to the current transformer's nominal voltage. When reading the measured value, additional error resulting from the clip-on current sensor must also be

taken into consideration (default value: **CL, P** = **OFF** = voltage display).

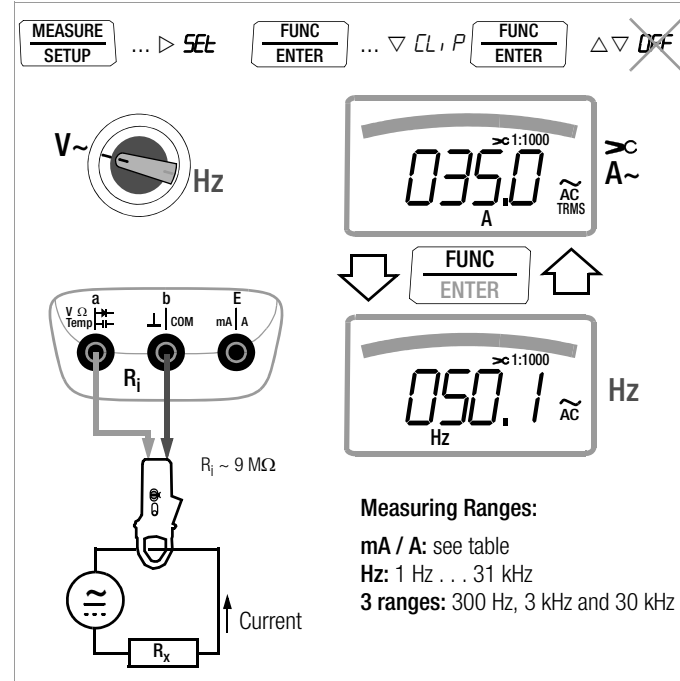

6 Measurements in Symmetrical Copper Cable Networks

6.1 “ R_{SL} ” Loop Impedance Measurement with 2 mA Constant Current

- ⇨ Disconnect supply power from the electrical circuit of the device to be measured, and discharge all high-voltage capacitors.
- ⇨ Make sure that the device under test is voltage-free. Interference voltages distort measurement results!
- ⇨ Set the rotary switch to R_{SL} . RSL appears at the display.
- ⇨ Connect the measuring point under test as shown.

Depending upon the selected limit value / threshold, the multimeter generates a continuous acoustic signal if the respective value is exceeded.

“OL” appears at the display in the case of an open connection.

The limit value can be adjusted in the “**SEtP**” menu (see also chapter 7.4):

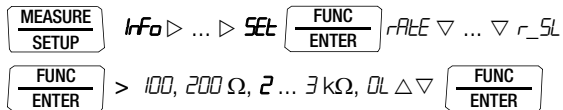

(2 = default setting)

Note

This measurement is particularly geared to the measurement in copper cable networks.

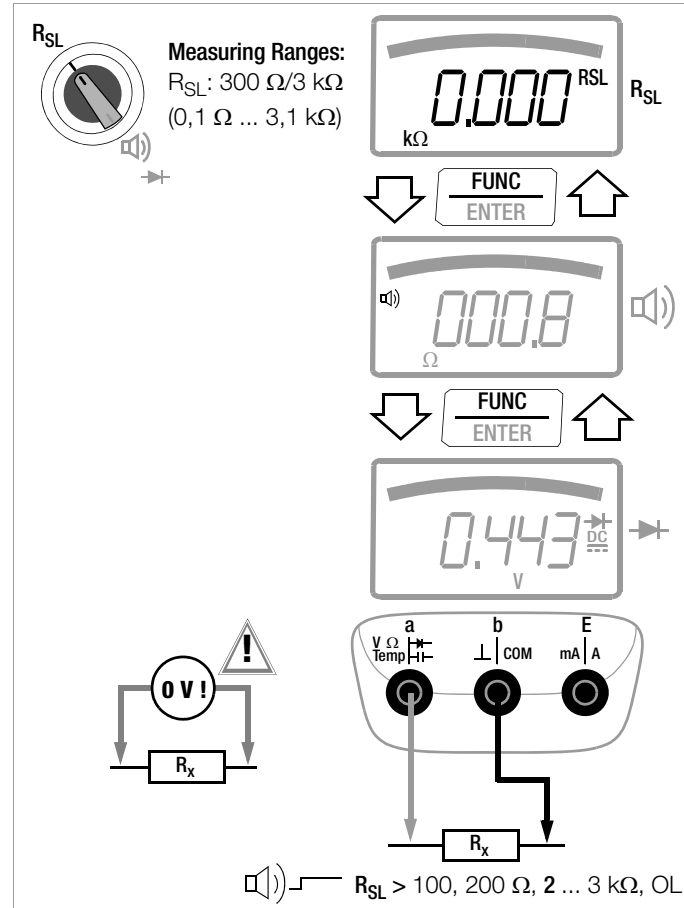

6.2 Detection of Interference Voltages

- ⇨ Set the rotary switch to the a-b, a-E and b-E positions, one after the other, in order to display any interference voltage for all three conductor pairs.



Note

Insulation resistance may only be measured at voltage-free devices.

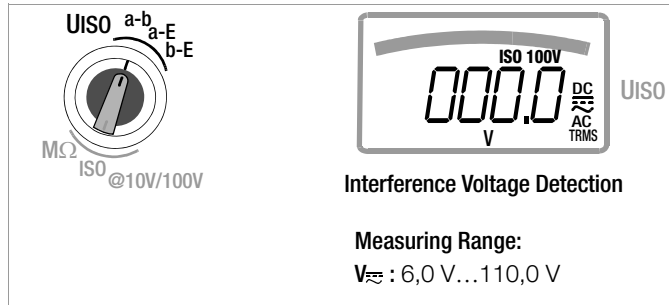

6.3 Insulation Resistance Measurement: in Telecommunications Networks – $M\Omega_{ISO}$ Function

Three jacks (a, b and E) are provided for **measurements in symmetrical copper cable networks** with two conductors and a shield. The rotary selector switch can be set to determine whether insulation testing will be performed between a and b, a and E or b and E.

Interruption of a single core or contact with an open-circuit core (capacitive asymmetry) can be recognized by switching rapidly with the **POL / UIiso** key.

In the event of a **good cable**, the bar graph must be identical in the a-E and b-E selector switch positions (open-circuit cable only!).

Long cable: long bar graph display

Short cable: short bar graph display

The overall length of the bar graph represents a range of capacitance from 50 nF to 100 nF.



Note

Insulation resistance measurement with 10 V test voltage

The measuring range of the digital display is limited to 30 $M\Omega$.

Exceeding values are shown as „OL“.

In contrast, the bargraph serves as a trend indicator and displays values up to 100 $M\Omega$, however, without any specified accuracy.

6.3.1 Connecting the Measurement Cables



Note

Testing the Measurement Cables

The test probes at the ends of the measurement cables should be short circuited before performing insulation resistance measurements with the selector switch in the Ω or the \square) position, in order to make sure that a value close to $0\ \Omega$ is displayed at the instrument. Incorrect connection or a broken measurement cable can be detected in this way.

↪ Cable connection:

Connect the measurement cables to jacks a, b and E.

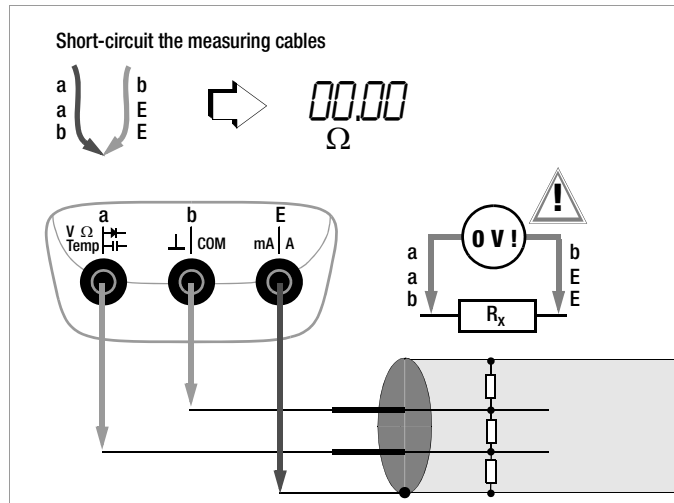

6.3.2 Selection of Test Voltage or Galvanic Signature

In the interference voltage detection mode you can select test voltages of 10 V or 100 V with the Δ or ∇ key. The selected test voltage is shown as a segment above the digital display, the signature recognition mode is shown as a digital display.

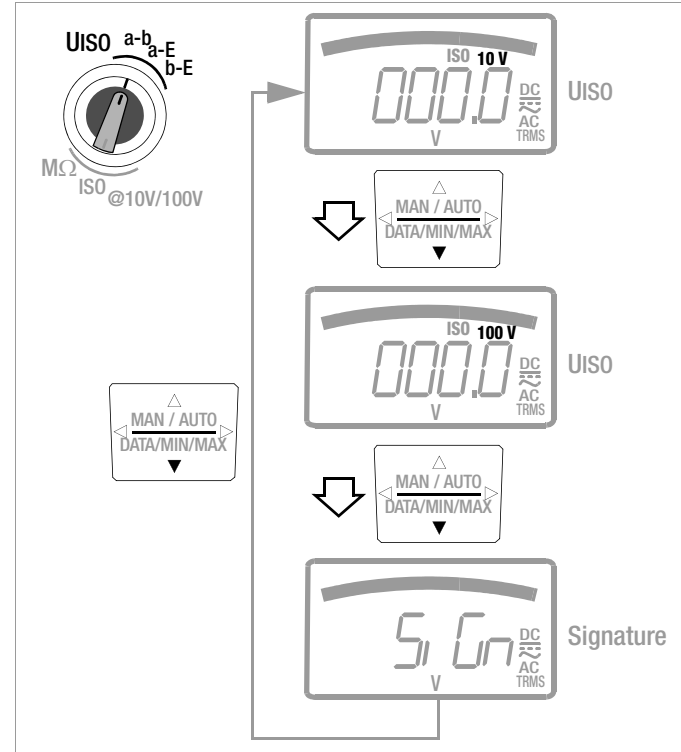

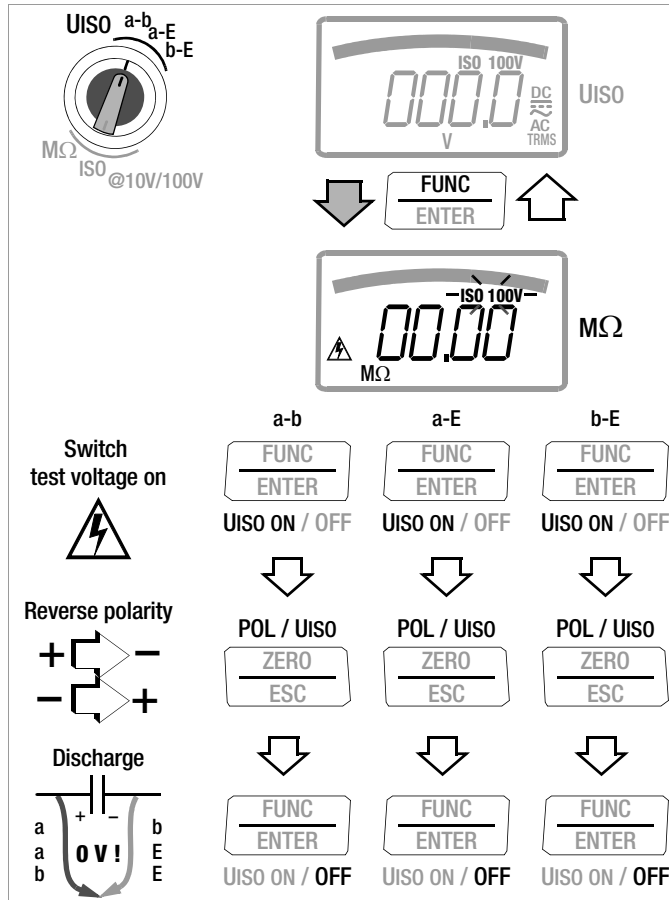

6.3.3 Performing Insulation Resistance Measurements



Caution High-Voltage!

Do not touch the conductive ends of the test probes when the instrument has been activated for the measurement of insulation resistance. If at all possible, only plug in the measurement cables actually required for this test, because loose test probes and cable ends represent a contact hazard. You may otherwise be exposed to a current of 1.5 mA (limited in the measuring instrument), and although this is not life endangering, the resulting electrical shock is quite discernible. If, on the other hand, measurement is being performed on a capacitive device under test, for example a cable, it may be charged up to approximately ± 120 V. Touching the device under test after measurement has been performed is life endangering in this case!

Starting the insulation resistance measurement:

Briefly press the **UIISO ON / OFF** key.

Insulation resistance is displayed for the currently selected conductor pair (analog display is logarithmic).

Reversing polarity of the cable under test:

– Normal polarity reversal:

Press and hold the **POL / UIISO** key.

– Rapid polarity reversal:

Press the **POL / UIISO** key at short intervals. **bAL.C** appears at the display (ballistic capacitance) for relative cable length determination. After key activation has ceased for a period of approximately 2 seconds, the instrument is switched back to standard insulation resistance measurement.

Switch the rotary selector switch to the $M\Omega_{ISO_a-b}$, $M\Omega_{ISO_a-E}$ and $M\Omega_{ISO_b-E}$ positions, one after the other, in order to execute the desired tests.

Auto-ranging is active during insulation resistance measurement. If the measured value is less than 10% of the measuring range after manual measuring range selection (see chapter 4.1.2), **ur** (under-range) appears at the display. You should then select the next smaller measuring range with the \triangleleft key.

Automatic Recognition of Interference Voltage During Insulation Resistance Measurement (only in AUTORANGE Mode)

If, during insulation measurement, the instrument detects an **interference voltage of greater than 15 V AC or 25 V DC** (assuming: $U_{in-terference} \neq U_{ISO}$, $R_{iq} < 100\text{ k}\Omega$), „Error“ is briefly displayed at the LCD. The instrument is then automatically switched to voltage measurement, and the currently measured voltage value is displayed.

Note

A polarity-dependent dead zone results in erroneous measurements for automatic interference voltage detection. The dead zone lies within a range of 60 to 135 V DC AC_{TRMS} sinusoidal (in the case of an interference voltage whose value is equal to that of measuring voltage, the two voltages neutralize each other).

Manual switching to insulation resistance measurement is disabled for as long as voltage is applied to the test terminals.

If interference voltage is no longer present, the $M\Omega_{ISO}$ measurement can be started by once again pressing the **Uiso ON / OFF** key.

If a **voltage of greater than 110 V DC AC** is present, it is indicated by means of an acoustic signal, as well as optically with the **“U HI”** symbol at the display.



Attention!

If „Error“ appears at the display, the cable (the device under test) is most likely capacitively charged to a significant extent. Remedy: Short circuit conductors a-b, a-E and b-E. Repeat the measurement.

6.3.4 Ending the Measurement and Discharging

⇒ Briefly press the **Uiso ON / OFF** key.

After measurement has been completed, any remaining residual voltage is displayed which may result from cable capacitance. The instrument's internal 120 k Ω resistor causes rapid discharging. However, contact to the device under test must be maintained. The falling voltage value can be observed directly at the LCD. **Do not disconnect the device under test until the voltage value has dropped to below 25 V!**



Note

The instrument's batteries are rapidly depleted during insulation resistance measurement. Deactivate insulation resistance measurement between measurements for this reason. Use only alkaline manganese batteries in accordance with IEC 6 LR61.



Note

Rotary selector switch positions a-b, a-E and b-E are intended solely for the detection of interference voltage up to 110 V during insulation resistance measurement. Voltage measurement may only be performed with the rotary selector switch set to the $V \sim$, $V \equiv$ or the $V \approx$ position. The DATA, MIN/MAX and ZERO functions are not available in this case.

6.4 Interference-immune Capacitance Measurement in Telecommunications Networks – CAP Function

Three jacks (a, b and E) are provided for **measurements in symmetrical copper cable networks** with two conductors and a shield. The rotary selector switch can be set to determine whether capacitance testing will be performed between a-b, a-E or b-E.

In contrast to the capacitance measurement in selector switch position , the measured value is only affected to a minor degree by line interference and/or parallel resistance with this capacitance measurement method.

- Connect the measuring cables to jacks a, b and E
- Set the rotary switch to „a-b, a-E and b-E“, one after the other, in order to display any interference voltage for all three conductor pairs, see also chapter 6.2.
- Press **ZERO | ESC**. The display switches from V to F. This conversion is accompanied by a double acoustic signal.
- Measure the capacitance successively in the 3 selector switch positions.
- Return to the interference voltage detection mode by pressing **ZERO | ESC** once more.



Note

„000.0 nF“ indicates a short circuit at the jacks.



Note

If an **activated** DSL modem/router is connected to the customer-side cable end emitting acoustic handshake signals, the high level of the signals will interfere with the measurement when short leads (up to approx. 500 m) are used. These signals can be attenuated by plugging on the signa-

ture measuring adapter, thus making measurement possible. The capacitance of 100 nF of measuring adapter SM100 must be taken into account for measurement.

6.4.1 Cable Length Measurement m

In the cable length mode the instrument calculates the length as a function of the capacitance value entered by the user:

$$\text{Length (km)} = \frac{\text{measured capacitance (nF)}}{\text{capacitance value (nF/km)}}$$

- Connect the measurement cables to jacks a, b and E
- Set the rotary switch to „a-b, a-E and b-E“, one after the other, in order to display any interference voltage for all three conductor pairs.
- Press **ZERO | ESC**. The display switches from V to F.
- Press multifunction key **FUNC | ENTER**. „k“ and „m“ are indicated for km length instead of „F“ in the display.
- Measure the cable length successively in the 3 selector switch positions.
- Return to the capacitance measuring mode by pressing **FUNC | ENTER** once more.

Refer to chapter 7.4 for details on setting the scaling factor „CAP“ (capacitive linear electric constant) for cable length measurement.



Note

Please make sure that the cable parameters (e.g. cross sections) are identical when determining the cable lengths. Differing cable parameters, e.g. in the case of cables composed of **different cable types or cross sections**, distort the measuring results.

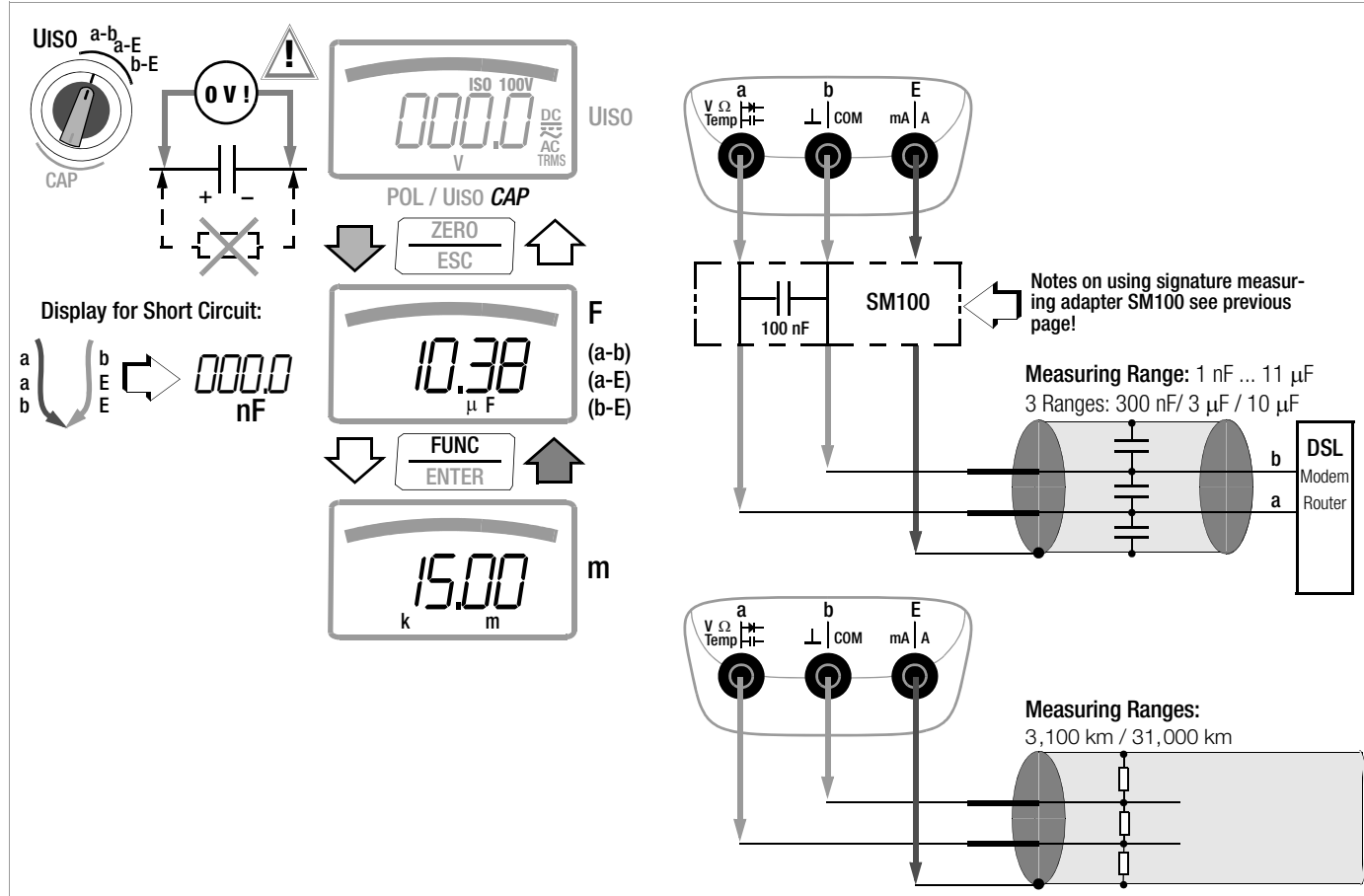

6.5 Galvanic Signature Recognition in Selector Switch Positions a-b

Measuring function for the recognition of a galvanic signature which may be contained in the connection cable of a DSL modem/router.

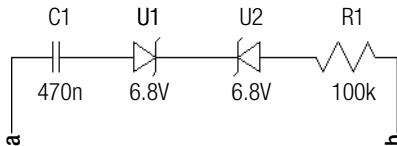

Electrical circuit diagram of a DSL signature

- Set the rotary switch to „a-b“ in order to display any interference voltage.
- Select the signature recognition function „**5** **G**“ with key Δ or ∇ .
- Start measurement with the **FUNC** | **ENTER** key.

Measurement is now conducted with a voltage below the conducting-state voltage of the Zener diodes: „**L** **V**“ is therefore shown in the display until the first measured value in the $\pm 300\%$ range is indicated. Since the measuring voltage is smaller than the threshold voltage of the Zener diodes of the signature, only parasitic influences are indicated in this case: this value is therefore subsequently designated as influence value.

If the influence value is stable, a high measuring voltage can be selected by pressing and holding the **ZERO** | **ESC** key. This is indicated in the display with „**H** **V**“.

If a value between approximately +60 and +200% is shown in the display, a signature exists, for values below +20%, however, no signature exists. Since this value determines whether a signature exists or not, it is subsequently designated as decision value.

The influence value last measured is taken into account for calculating the decision value: It is therefore of importance that the influence value is stable and remains within the applicable range between -50% and $+30\%$! The display blinks if the value is beyond that range.

Notes

Prerequisites for the application of the signature measurement

Parallel resistance $> 200\text{ k}\Omega$, parallel capacitance $< 1\text{ }\mu\text{F}$,
Ripple voltage $< 4\text{ V}_{SS}\ 50\text{ Hz}$
and exclusively high-resistance DC voltage

Passive test termination between a and b

A passive test termination leads to a deviation $< 10\%$ for both values and can thus be neglected for the signature recognition.

Signature at the output of a DSL splitter

If the signature is located at the output of a DSL splitter (operation according to Annex B), it is not recognized due to the high-pass filter in the splitter. If it is attached to the F jack (low-pass) by mistake, the signature is recognized nevertheless.

NTBA connected

If an NTBA is connected, measurement is not possible as the input circuit of the NTBA prevents recognition
(influence value = –OL)

DSL modem active

If a DSL modem is active and the connector cable is very short (< 500 m), an SM100 signature adapter must be plugged on in order to attenuate the DSL signals (handshake signals). The SM100 adapter attenuates the acoustic handshake signals, thus making measurement possible.

This adapter, however, must be removed from the instrument for all other tests and measurements except for the capacitance measurement with connected DSL modem/router described above, see chapter 6.4.

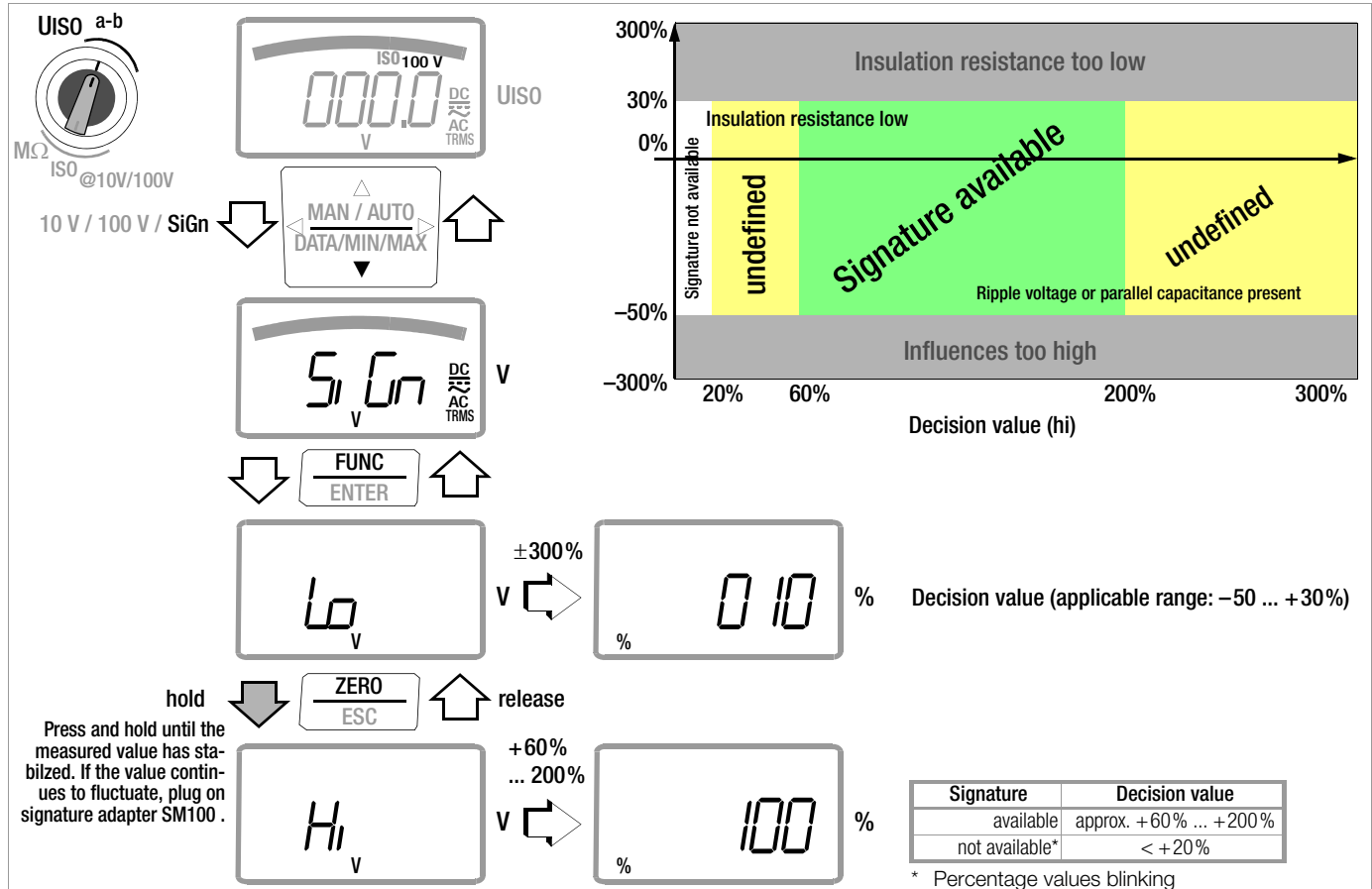

7 Device and Measuring Parameters

The instrument's "**SEtUP**" mode (menu mode) makes it possible to set operating and measuring parameters, query information and activate the interface.

- ⇨ The menu mode is accessed by pressing the **MEASURE | SETUP** key, assuming that the instrument is switched on and set to "Measure" (measuring mode operation). "**Info**" appears at the display.
- ⇨ The main menus, i.e. the "**SEt**" and "**LEtP**" menus, as well as the "**SEnd**" and "**StorE**" menus, are accessed, and the display is returned to "**Info**", by repeatedly activating the $\triangleleft \triangleright \triangle \nabla$ keys (in any direction).
- ⇨ After selecting the desired main menu, sub-menus are accessed by pressing the **FUNC | ENTER** key.
- ⇨ The desired parameter is selected by repeatedly pressing the $\triangle \nabla$ keys.
- ⇨ In order to check or change a parameter, acknowledge it with the **FUNC | ENTER** key.
- ⇨ The $\triangleleft \triangleright$ keys can be used to position the cursor at the entry position.
The desired value is selected with the help of the $\triangle \nabla$ keys.
- ⇨ Changes can only be accepted with the **FUNC | ENTER** key.
- ⇨ You can return to the sub-menu without making any changes by pressing the **ZERO | ESC** key, and to the main menu by pressing the **ZERO | ESC** key once again etc.
- ⇨ You can switch to the measuring mode from any menu level by pressing the **FUNC | ENTER** key.

After repeatedly pressing the **MEASURE | SETUP** key (without first turning the multimeter off), you can return to the last selected menu or parameter from the measuring mode.

Example: Setting Time

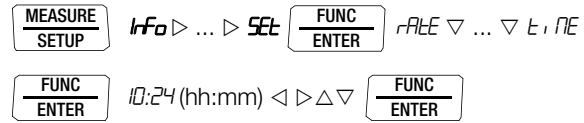

Setting hours and minutes:

- $\triangleleft \triangleright$ Advance to desired entry position.
 - $\triangle \nabla$ Change the setting, the entry position blinks.
Press and hold the key to change the setting rapidly.
- The new time setting is activated after acknowledgement.

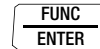

7.1 Paths to the Various Parameters

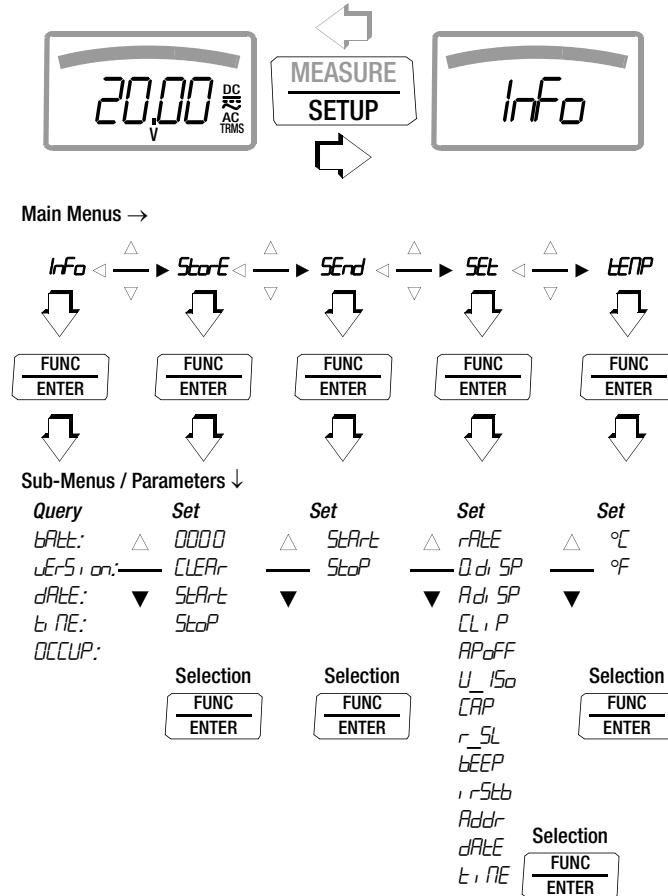

7.2 List of All Parameters

Parameter	Page: Header
0, d, SP	54: 0.diSP – show/hide leading zeros
Addr	59: Configuring Interface Parameters
R, d, SP	55: A.diSP – analog display: select display mode
APoFF	55: APoFF – specified time for automatic shutdown and continuous ON
bAtt	54: bAtt – query battery voltage
bEEP	55: bEEP – set limit value for continuity testing
CAP	56: CAP – scaling factor for cable length measurement (capacitive linear electric constant)
CLEAR	23: Measurement Data Recording
CL, P	39: Direct and Pulsating Current Measurement with Clip-On Current Sensor, A DC and A (DC+AC) 40: Alternating Current Measurement with Clip-On Current Sensor, A AC and Hz
dAtE	54: dAtE – query date, 56: dAtE – enter date
EMPTY	23: Measurement Data Recording
Info	54: Querying Parameters – InFo Menu (as moving letters)
rStb	59: Configuring Interface Parameters
OCCUP	23: Measurement Data Recording
rAtE	54: rAtE – set the sampling rate
r_SL	56: r_SL – set limit value for protective conductor resistance
SEnd	58: Activating the Interface
SEt	54: Entering Parameters – SETUP Menu
StArT	
StOp	23: Measurement Data Recording
StOrE	
tNE	31: Temperature Measurement – Temp RTD
U_150	54: tIME – query time, 56: tIME – set time
U_150	55: U_150 – select test voltage
vErSion	54: vErSion – query firmware version

Device and Measuring Parameters

7.3 Querying Parameters – InFo Menu (as moving letters)



bAtt – query battery voltage

 *Info*  *bAtt: 2.75 V.*

vErSion – query firmware version

 *Info*  *bAtt: ▽ vErSion: 1.00*

dAtE – query date

 *Info*  *bAtt: ▽ ... ▽ dAtE: 31.12.05 (DD.MM.YY)*

D = day, M = month, Y = year

Date and time must be reentered after replacing the batteries.

tiME – query time

 *Info*  *bAtt: ▽ ... ▽ tiME: 13:46:56*

(hh:mm:ss)

h = hours, m = minutes, s = seconds

Date and time must be reentered after replacing the batteries.

OCCUP – query memory occupancy

 *Info*  *bAtt: ▽ ... ▽ OCCUP: 000.0%*

7.4 Entering Parameters – SETUP Menu

rAtE – set the sampling rate

The sampling rate specifies the time interval after which the respective measured value is transmitted to the interface, or to measured value memory.

Any one of the following sampling rates can be selected:

[mm:ss.t]: 00:00,1, 00:00,2, **00:00,5**, 00:01,0, 00:02,0, 00:05,0
[h:mm:ss.t] (h=hours, m=minutes, s=seconds, z=tenths of a sec.):
0:00:10, 0:00:20, 0:00:30, 0:00:40, 0:00:50, 0:01:00, 0:02:00,
0:05:00, 0:10:00, 0:20:00, 0:30:00, 0:40:00, 0:50:00, 1:00:00,
2:00:00, 3:00:00, 4:00:00, 5:00:00, 6:00:00, 7:00:00, 8:00:00,
9:00:00



Setting the Sampling Rate

 *Info* > ... > **SET**  *rAtE* 
00:00,1 ... 00:00,5 ... 9:00:00 ▽ ▽ 

(00:00,5 = 0.5 s = default value)

0.diSP – show/hide leading zeros

This parameter determines whether or not leading zeros will appear in the measured value display.

 *Info* > ... > **SET**  *rAtE* ▽ ... ▽ *0.diSP* 

0000,0 : with leading zeros (default value)

0,0 : leading zeros suppressed

△ ▽ 

A.diSP – analog display: select display mode

One of two different display modes can be selected for the analog display:

- *bAR-G*: bar graph
- *Po, rnt*: pointer

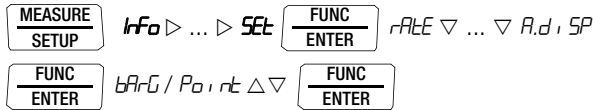

(*Po, rnt* = default setting)

APoFF – specified time for automatic shutdown and continuous ON

The instrument is switched off automatically if the measured value remains unchanged for a long period of time and if none of the keys or the rotary switch have been activated before the specified time “*APoFF*” (entered in minutes) has elapsed.

If the *oN* setting is selected, the multimeter is set for long-term measurement and *oN* appears in the display to the right of the battery symbol. In this case, the multimeter can only be switched off manually. The “*oN*” setting can only be cancelled by changing the respective parameter, and not by switching the instrument off.

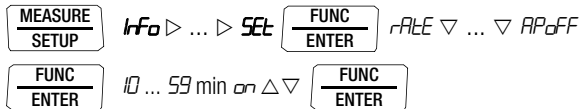

(10 minutes = default setting)

U_ ISo – select test voltage

The desired test voltage for insulation resistance measurement can be selected here:

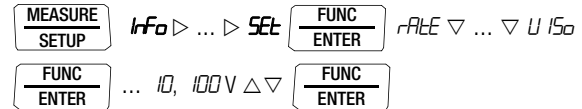

bEEP – set limit value for continuity testing

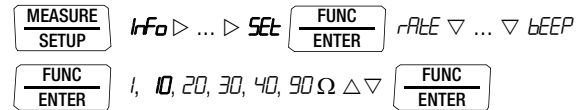

(10 Ω = default setting)

irStb – status of the infrared receiver in the stand-by mode

See chapter 8.2 on page 59 regarding settings.

Addr – set device address

See chapter 8.2 on page 59.

Device and Measuring Parameters

dAtE – enter date

Entering the current date makes it possible to acquire measured values in real-time.

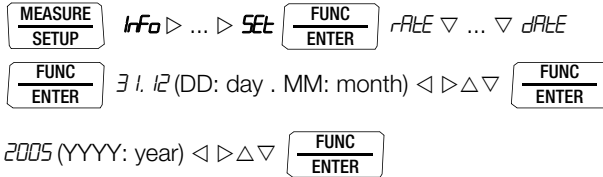

Date and time must be reentered after replacing the batteries.

tiME – set time

Entering the correct time makes it possible to acquire measured values in real-time.

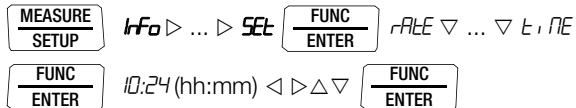

Date and time must be reentered after replacing the batteries.

CLIP – set current clip factor

See chapter 5.7.3 and chapter 5.7.4.

r_SL – set limit value for protective conductor resistance

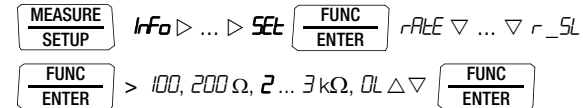

(2 = default setting)

CAP – scaling factor for cable length measurement (capacitive linear electric constant)

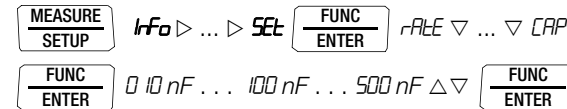

(100 nF = default setting)_

7.5 Default Settings

Previously entered changes can be undone, and the default settings can be reactivated. This may be advisable under the following circumstances:

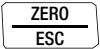
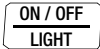
- after the occurrence of software or hardware errors,
 - if you are under the impression that the multimeter does not work correctly.
- ⇒ **Disconnect the device from the measuring circuit.**
- ⇒ Remove the batteries temporarily (see also chapter 10.2).
- ⇒ Simultaneously press and hold the  and  keys, and connect the battery at the same time.

8 Interface Operation

The cable multimeter is equipped with an infrared interface for the transmission of measurement data to a PC. Measured data are optically transferred through the instrument housing by means of infrared light to an interface adapter (accessory), which is attached to the multimeter. The adapter's USB interface allows for the establishment of a connection to the PC via an interface cable. Beyond this, commands and parameters can be transmitted from the PC to the multimeter as well. The following functions can be executed:

- Configuration and read-out of measuring parameters,
- Measuring function and measuring range selection,
- Start measurement,
- Read out stored measured values.

8.1 Activating the Interface

The interface is automatically activated for receiving operation (multimeter receives data from the PC) as soon as the interface is addressed by the PC, assuming that the “*rStt*” parameter has been set to “*1 rOn*” (see chapter 8.2), or the instrument is already switched on (the first command wakes up the multimeter, but does not yet execute any further commands).

The “continuous transmission” operating mode is selected manually as described below. In this operating mode, the instrument continuously transmits measurement data to the PC via the interface adapter, which can then be displayed with the help of a terminal program.

Starting Continuous Transmission Operation with Menu Functions

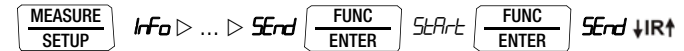

The **↓IR↑** symbol blinks at the display in order to indicate interface operation.

Stopping Continuous Transmission Operation with Menu Functions

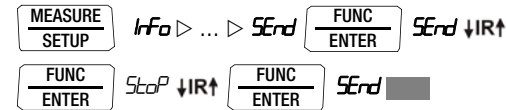

The **↓IR↑** symbol is cleared from the display.

Automatic Activation and Deactivation of Transmission Mode Operation

If the sampling rate is 10 seconds or longer, the display is switched off automatically between samples in order to prolong battery service life. The only exception is when the multimeter is set to continuous operation.

As soon as an event occurs, the display is automatically switched back on.

8.2 Configuring Interface Parameters

irStb – status of the infrared receiver in the stand-by mode

There are two possible switching statuses for the infrared interface when the multimeter is switched off:

- ir on*: IR appears at the display and the infrared interface is active, i.e. signals such as making commands can be received, and power is consumed even though the multimeter is switched off.
- ir off*: IR does not appear at the display and the infrared interface is switched off, signals cannot be received.

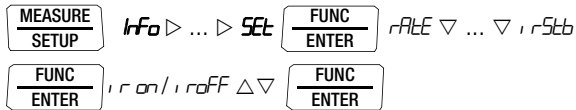

(*irStb* = *ir off* = default setting)

Addr – Address

If several multimeters are connected to the PC via an interface adapter, a separate address can be assigned to each instrument. Address number 1 should be selected for the first instrument, 2 should be assigned to the second and so forth.

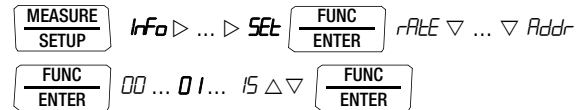

(15 = default setting)

9 Technical Data

Meas. Function (input)	Measuring Range	Resolution at Upper Range Limit	Input impedance		Intrinsic Uncertainty under Reference Conditions			Overload Capacity ²⁾	
					$\pm (... \% \text{ rdg.} + ... \text{ d})$	$\pm (... \% \text{ rdg.} + ... \text{ d})$	$\pm (... \% \text{ rdg.} + ... \text{ d})$	Value	Time
					\equiv	\sim / \approx	\approx		
V (a)	300.0 mV	100 μ V	9 M Ω	9 M Ω // < 50 pF	$0.5 + 3^{10)}$	$1.5 + 3 (> 300 \text{ d})$	$1.5 + 3 (> 300 \text{ d})$	600 V DC AC RMS Sine 6	Cont.
	3.000 V	1 mV	9 M Ω	9 M Ω // < 50 pF	$0.5 + 1$	$1.5 + 3 (> 30 \text{ d})$	$1.5 + 3 (> 100 \text{ d})$		
	30.00 V	10 mV	9 M Ω	9 M Ω // < 50 pF	$0.5 + 1$				
	300.0 V	100 mV	9 M Ω	9 M Ω // < 50 pF	$0.5 + 1$				
	600 V	1 V	9 M Ω	9 M Ω // < 50 pF	$0.5 + 1$				
			Voltage drop at approx. range limit		\equiv	\sim 1), 11)	\approx 1), 11)		
A (E)	300.0 μ A	100 nA	18 mV	18 mV	$0.5 + 5$	$1.5 + 5 (> 100 \text{ d})$	$1.5 + 5 (> 100 \text{ d})$	0.3 A	Cont.
	3.000 mA	1 μ A	160 mV	160 mV	$0.5 + 3$	$1.5 + 5 (> 30 \text{ d})$	$1.5 + 5 (> 100 \text{ d})$		
	30.00 mA	10 μ A	32 mV	32 mV					
	300.0 mA	100 μ A	320 mV	320 mV					
	1.000 A	1 mA	600 mV	600 mV	$0.5 + 5$			1.6 A	5 min.
	Factor: 1:1/10/100/1000	Input	Input impedance		\equiv 10)	\sim 1), 11)	\approx 1), 11)		
A (a)	0.3/3/30/300 A	300 mV	Voltage measurement input approx. 9 M Ω (V socket)		$0.5 + 3$	$1.5 + 3 (> 300 \text{ d})$	$1.5 + 3 (> 300 \text{ d})$	Measurement input	
	3/30/300/3k A	3 V				$1.5 + 3 (> 30 \text{ d})$	$1.5 + 3 (> 100 \text{ d})$	600 V TRMS	Max. 10 s
	30/300/3k/30k A	30 V				Plus clip-on current sensor error			
			Open-circuit voltage	Meas. current at range limit	$\pm (... \% \text{ rdg.} + ... \text{ d})$				
Ω (a)	300.0 Ω	100 m Ω	< 1.4 V	Approx. 250 μ A	$0.5 + 3^{10)}$		600 V DC AC RMS Sine	Max. 10 s	
	3.000 k Ω	1 Ω	< 1.4 V	Approx. 160 μ A	$0.5 + 1$				
	30.00 k Ω	10 Ω	< 1.4 V	Approx. 28 μ A	$0.5 + 1$				
	300.0 k Ω	100 Ω	< 1.4 V	Approx. 2.9 μ A	$0.5 + 1$				
	3.000 M Ω	1 k Ω	< 1.4 V	Approx. 0.31 μ A	$0.5 + 1$				
	30.00 M Ω	10 k Ω	< 1.4 V	Approx. 33 nA	$2.0 + 5$				
R_{SL}	300.0 Ω	100 m Ω	Approx. 13 V	Approx. 2 mA const.	$3 + 5$		600 V DC AC RMS Sine	Max. 10 s	
	3.000 k Ω	1 Ω	Approx. 13 V		$3 + 5$				
d)	300.0 Ω	100 m Ω	Approx. 3 V	Approx. 1 mA const.	$3 + 5$				
d)	5.1 V ³⁾	1 mV	Approx. 13 V		$2 + 5$				

				Discharge resist.	U_0 max	$\pm (... \% \text{ rdg.} + ... \text{ d})$		
F (a)	30.00 nF	10 pF	10 M Ω	0.7 V	$1 + 6^{4), 10)}$	600 V DC AC RMS Sine	Max. 10 s	
	300.0 nF	100 pF	1 M Ω	0.7 V	$1 + 6^{4)}$			
	3.000 μ F	1 nF	100 k Ω	0.7 V	$1 + 6^{4)}$			
	30.00 μ F	10 nF	12 k Ω	0.7 V	$1 + 6^{4)}$			
	300.0 μ F	100 nF	3 k Ω	0.7 V	$5 + 6^{4)}$			
				$f_{\text{min}}^{5)}$	$\pm (... \% \text{ rdg.} + ... \text{ d})$			
Hz (V)/ Hz (A)	300.0 Hz	0.1 Hz	1 Hz		$0.5 + 1^{8)}$	Hz (V) ⁶⁾ , Hz(A) ⁶⁾ , 600 V	Max. 10 s	
	3.000 kHz	1 Hz	10 Hz					
	30.00 kHz	10 Hz	100 Hz					
Hz (V)	300.0 kHz	100 Hz				Hz (A): ⁷⁾		
						$\pm (... \% \text{ rdg.} + ... \text{ d})^{9)}$		
°C	Pt100	-200.0 ... +200.0 °C	0.1 °C			2 K + 5	600 V DC/AC RMS Sine	Max. 10 s
		+200.0 ... +850.0 °C				1 + 5		
	Pt1000	-150.0 ... +200.0 °C				2 K + 5		
		+200.0 ... +850.0 °C				1 + 5		

¹⁾ 15 ... 45 ... 65 Hz ... 10 (5) kHz sine. See following page for influences.

²⁾ At 0° ... + 40° C

³⁾ Display of up to max. 5.1 V, "OL" in excess of 5.1 V.

⁴⁾ Applies to measurements at film capacitors and with battery operation

⁵⁾ Lowest measurable freq. for sinusoidal meas. signals symmetrical to zero point

⁶⁾ Overload capacity of the voltage measurement input: power limiting:
frequency x max. voltage 6×10^6 V x Hz: e.g. max. 600 V 1 kHz

⁷⁾ Overload capacity of the current measurement input:

See current measuring ranges for maximum current values.

⁸⁾ Input sensitivity, sinusoidal signal, 10% to 100% of the voltage or current measuring range; limitation: up to 30% of the range at up to 100 kHz in the mV measuring range, 50% of the range at up to 300 kHz, 30% of the range in the 1 A measuring range.
The voltage measuring ranges with max. 30 kHz apply in the A Ω measuring range.

⁹⁾ Plus sensor deviation

¹⁰⁾ With ZERO function active

¹¹⁾ Residual value of 1 to 10 d with short circuited terminal tips,

exception: mV / μ A range of 1 to 35 d at zero point due to the TRMS converter

Key: R = meas. range, d = digit(s), rdg. = measured value (reading)

Insulation Resistance Measurement in Selector Switch Positions (a-b) (a-E) (b-E) ¹⁾

Measuring Range	Resolution	Nominal Voltage U_{ISO} (U_{INS})	Intrinsic Error under Reference Conditions \pm (% rdg + d)
6 V ... 110 V \approx ²⁾	0.1 V	Ri approx. 120 k Ω	3 + 30
5 ... 310.0 k Ω	0.1 k Ω	10//100 V	3 + 5
0.280 ... 3.100 M Ω	1 k Ω	10//100 V	3 + 5
02.80 ... 31.00 M Ω	10 k Ω	10//100 V	5 + 5
028.0 ... 310.0 M Ω	100 k Ω	10//100 V	5 + 5

¹⁾ During insulation resistance measurement ($M\Omega_{@U_{ISO}}$): If ERROR is displayed as „Error“ >> limits: $U_{interference} > 10 \dots 20$ V and $U_{interference} \neq U_{ISO}$, $Ri < 10$ k Ω @ U_{iso} 10 V, $Ri < 100$ k Ω @ U_{iso} 100 V

²⁾ Interference voltage measurement TRMS (V AC + DC) with 120 k Ω input resistance, bandwidth 15 Hz ... 500 Hz, measuring error 3% + 30 Digit

Measuring Function Switch Setting	Nom. Voltage U_N @100k	Open-Circuit Voltage U_o	Nom. Current I_N @100k	Short-Circuit Current I_k	Acoustic Signal for	Overload Capacity	
						Value	Time
$U_{interference}/M\Omega_{ISO}$	—	—	—	—	$U > 110$ V	110 V \approx	Cont.
$M\Omega_{ISO}$	100 V	Max. 120 V	> 1.0 mA	< 1.2 mA	$U > 110$ V	100 V \approx	10 s
	8.7 V	11 V	0.09	< 0.260	$U > 110V$	100 V \approx	10 s

Ripple voltage < 4 Vss 50 Hz, parallel capacitance < 3 μ F

Interference-immune Capacitance Measurement in Selector Switch Positions (a-b) (a-E) (b-E)

Measuring Range	Resolution 3100/1100 Digit	Intrinsic Uncertainty under Reference Conditions \pm (... % rdg. + ... d)	Measuring Cycle (max.)	Overload Capacity
300 nF	100 pF	2 + 10	2 s	600 V / PTC max. 10 s
3 μ F	1 nF	2 + 10	2 s	
10 μ F	10 nF	5 + 10	2 s	

Measuring voltage $U_0 = 2$ Vss approx. 1 Hz, parallel resistance > 5 M Ω

Ripple voltage < 4 Vss 50 Hz

Galvanic Signature Ascertainment in Selector Switch Positions (a-b)

Signature	if interference value is stable in range	plus decision value
available	-50% ... +30%	approx. +60% ... +200%
not available		< +20%

Prerequisites:

Parallel resistance > 200 k Ω , parallel capacitance < 1 μ F,

Ripple voltage < 4 Vss 50 Hz

and exclusively high-resistance DC voltage

Influencing Quantities and Influence Error

Influencing Quantity	Sphere of Influence	Measured Quantity / Measuring Range ¹⁾	Influence Error (...% rdg. + ... d) / 10 K
Temperature	0 °C ... +21° C and +25° C ... +40° C	V \approx	0.2 + 5
		V \sim	0.4 + 5
		300 Ω ... 3 M Ω	0.5 + 5
		30 M Ω	1 + 5
		mA/A \approx	0.5 + 5
		mA/A \approx	0.8 + 5
		30 nF ... 300 μ F	1 + 5
		Hz	0.2 + 5
		°C/°F (Pt100/Pt1000)	0.5 + 5

¹⁾ With zero balancing

Influencing Quantity	Measured Quantity / Measuring Range	Sphere of Influence	Intrinsic Error ³⁾ ± (... % rdg. + ... d)	
Frequency	V _{AC} 2)	300 mV	> 15 Hz ... 45 Hz	
		...		
		300 V	> 65 Hz ... 10 kHz	
		600 V	> 65 Hz ... 5 kHz	3 + 5 > 60 digits
	A _{AC}	300 µA	> 15 Hz ... 45 Hz	3 + 10 > 300 digits
		...		
		1 A	> 65 Hz ... 10 kHz	
	A _{AC} +DC	300 µA	> 15 Hz ... 45 Hz	3 + 30 > 300 digits
...				
	1 A	> 65 Hz ... 10 kHz		
A _{AC} Σ	300 mV / 3 V / 30 V	> 65 Hz ... 10 kHz	3 + 5 > 300 digits	

2) Power limiting: frequency x voltage, max. 6×10^6 V x Hz

3) The accuracy specification is valid as of a display value of 10% and up to 100% of the measuring range for both measuring modes with the TRMS converter in the A AC and A (AC+DC) ranges.

Influencing Quantity	Sphere of Influence	Measured Quantity / Measuring Range	Influence Error ⁵⁾
Crest Factor CF	1 ... 3	V ~, A ~	± 1% rdg.
	> 3 ... 5		± 3% rdg.

5) Except for sinusoidal waveshape

Influencing Quantity	Sphere of Influence	Measured Quantity	Influence Error
Relative Humidity	75%, 3 days, instrument off	V, A, Ω, F, Hz, °C	1 x intrinsic error
Battery voltage	1.8 to 3.6 V	ditto	Included in intrinsic error
Mains operation	5 V	ditto	± 10 Digit

Influencing Quantity	Sphere of Influence	Measured Qty. / Measuring Range	Damping
Common Mode Interference Voltage	Interference quantity max. 600 V ~	V ≡	> 120 dB
		3 V ~, 30 V ~	> 80 dB
	Interference quantity max. 600 V ~ 50 Hz ... 60 Hz, sine	300 V ~	> 70 dB
		600 V ~	> 60 dB
Series Mode Interference Voltage	Interference quantity: V ~, respective nominal value of the measuring range, max. 600 V ~, 50 Hz ... 60 Hz sine	V ≡	> 50 dB
		Interference quantity max. 600 V —	V ~

Response Time (after manual range selection)

Measured Quantity / Measuring Range	Response Time Digital Display	Measured Quantity Jump Function
V ≡, V ~ A ≡, A ~	1.5 s	From 0 to 80% of upper range limit value
300 Ω ... 3 MΩ	2 s	From ∞ to 50% of upper range limit value
30 MΩ	5 s	
Continuity	< 50 ms	
°C (Pt 100)	Max. 3 s	
→	1.5 s	From 0 to 50% of upper range limit value
30 nF ... 300 µF	Max. 5 s	
> 10 Hz	1.5 s	

Reference Conditions

Ambient temperature	+ 23° C ± 2 K
Relative humidity	40% to 75%
Meas. Qty. Freq.	45 Hz ... 65 Hz
Meas. Qty. Waveshape	Sine
Battery voltage	3 V ± 0.1 V

Technical Data

Ambient Conditions

Accuracy range	0° C ... +40° C
Operating temp. range	-10° C ... +50° C
Storage temp. range	-25° C ... +70° C (without batteries)
Relative humidity	40 to 75%, no condensation allowed
Elevation	to 2000 m
Deployment	Indoors, except within specified ambient conditions

Display

LCD panel (65 mm x 36 mm) with analog and digital display including unit of measure, type of current and various special functions

Background illumination

Background illumination is switched off approximately 1 minute after it has been activated.

Analog

Display	LCD scale with bar graph or pointer, depending upon the selected parameter setting
Scaling	<u>Linear</u> (ranges other than $M\Omega_{ISO}$): $\mp 5 \dots 0 \dots \pm 30$ with 35 scale divisions for \Rightarrow , $0 \dots 30$ with 30 scale divisions in all other ranges <u>Logarithmic</u> ($M\Omega_{ISO}$ range): $\dots \leq 0.3 \dots 3 \dots 30 \dots 300$, bar graph instead of pointer
Polarity display	With automatic switching
Overflow display	With the ► symbol
Measuring rate	40 measurements per second and display refresh

Digital

Display / Char. Height	7-segment characters / 15 mm
Number of places	3¾ places, \cong 3100 steps
Overflow display	“OL” is displayed for ≥ 3100 digits
Polarity display	“-” (minus sign) is displayed if plus pole is connected to “ \perp ”
Measuring rate	10 and 40 measurements per second with the Min/Max function except for the capacitance, frequency and duty cycle measuring functions
Refresh Rate	2 times per sec., every 500 ms

Electrical Safety

Safety class	II per DIN EN 61010-1:2011/ VDE 0411-1:2011	
Measuring category	II	III
Nominal voltage	600 V	300 V
Fouling factor	2	
Test voltage	3.5 kV~ per DIN EN 61010-1:2011/ VDE 0411-1:2011	

Fuses

Fuse link	FF 1.6 A/700 V AC/DC; 6.3 mm x 32 mm; switching capacity: 50 kA at 700 V AC/DC; protects the current measurement input in the 300 μ A through 1 A ranges
-----------	---

Power Supply

- Battery 2 ea. 1.5 V mignon cell (2 ea. size AA), alkaline manganese per IEC LR6
- Service life With alkaline manganese batteries: approx. 200 hours without $M\Omega_{ISO}$ measurement
- Battery test Battery capacity display with battery symbol in 4 segments: . Querying of momentary battery voltage via menu function.
- Power OFF function The multimeter is switched off automatically:
 – If battery voltage drops to below approx. 1.8 V
 – If none of the keys or the rotary switch are activated for an adjustable duration of 10 to 59 minutes, and the multimeter is not in the continuous operation mode
- Power pack socket If the power pack has been plugged into the instrument, the installed batteries are disconnected automatically. Rechargeable batteries can only be recharged externally.

Measuring Function	Nominal Voltage U_N	Resistance of the DUT	Service life in Hours	Number of Possible Measurements with Nominal Current per VDE 0413
V \equiv			200 ¹⁾	
V \sim			150 ¹⁾	
M Ω	10 V/100 V	1 M Ω	50	
	10 V/100 V	100 k Ω		3000

¹⁾ Times 0.7 for interface operation

Electromagnetic Compatibility (EMC)

- Interference emission EN 61326-1:2013 class B
- Interference immunity EN 61326-1:2013
EN 61326-2-1:2013

Data Interface

- Type Optical via infrared light through the housing
- Data transmission Serial, bidirectional (not IrDa compatible)
- Protocol Device specific
- Baud Rate 38,400 baud
- Functions
- Select/query measuring functions and parameters
 - Query momentary measurement data

The USB | **X-TRA** plug-in interface adapter (see accessories) is used for adaptation to the PC's USB port.

Internal Measured Value Storage

- Memory capacity 4 MBit / 540 kB for approx. 15,400 measured values with indication of date and time

Technical Data

Mechanical Design

Housing	Impact resistant plastic (ABS)
Dimensions	200 x 87 x 45 mm (without protective rubber cover)
Weight	Approx. 0.35 kg with batteries
Protection	Housing: IP 54 (pressure equalization by means of the housing)

Table Excerpt Regarding Significance of the IP Code

IP XY (1 st digit X)	Protection against foreign object entry	IP XY (2 nd digit Y)	Protection against the penetration of water
0	Not protected	0	Not protected
1	≥ 50.0 mm dia.	1	Vertically falling drops
2	≥ 12.5 mm dia.	2	vertically falling drops with enclosure tilted 15°
3	≥ 2.5 mm dia.	3	Spraying water
4	≥ 1.0 mm dia.	4	Splashing water
5	Dust protected	5	Water jets

10 Maintenance and Calibration



Attention!

Disconnect the instrument from the measuring circuit before opening the battery compartment lid or fuse cover when replacing batteries or fuses!

10.1 Displays – Error Messages

Message	Function	Meaning
FUSE	Current measurement	Blown fuse
	In all operating modes	Battery voltage has fallen below 1.8 V
OL	Measurement	Indicates overflow
μ	$M\Omega_{ISO}$ measurement	Measured value of less than 10% of the measuring range
Error	$M\Omega_{ISO}$ measurement	Interference voltage detected

10.2 Batteries



Note

Removing the Batteries During Periods of Non-Use

The integrated quartz movement draws power from the batteries even when the instrument is switched off. It is advisable to remove the batteries during long periods of non-use for this reason (e.g. vacation). This prevents excessive depletion of the battery, which may result in damage under unfavorable conditions.



Note

Battery Replacement

Stored measurement data are lost when the batteries are replaced. In order to prevent data loss, it is advisable to

backup your data to a PC with the help of **METRAWIN 10** software before replacing the batteries.

The selected operating parameters remain in memory, although date and time must be reentered.

Battery

The current battery charge level can be queried in the “**Info**” menu:



Make sure that no battery leakage has occurred before initial start-up, as well as after long periods of storage. Continue to inspect the batteries for leakage at short, regular intervals.

If battery leakage has occurred, carefully and completely clean the electrolyte from the instrument with a damp cloth, and replace the battery before using the instrument.

If the “” symbol appears at the display, the batteries should be replaced as soon as possible. You can continue working with the instrument, but reduced measuring accuracy may result.

The instrument requires two 1.5 V batteries in accordance with IEC LR 6, or two equivalent rechargeable NiCd batteries.

Replacing the Batteries



Attention!

Disconnect the instrument from the measuring circuit before opening the battery compartment lid in order to replace the batteries.

- ⇨ Set the instrument face down onto the working surface.
- ⇨ Turn the slotted screw on the lid with the battery symbols counterclockwise.
- ⇨ Lift off the lid and remove the batteries from the battery compartment.
- ⇨ Insert two new 1.5 V mignon batteries into the battery compartment, making sure that the plus and minus poles match up with the provided polarity symbols.
- ⇨ When replacing the battery compartment lid, insert the side with the guide hooks first. Tighten the screw by turning it clockwise.
- ⇨ Please dispose of depleted batteries in accordance with environmental protection regulations!

10.3 Fuses

Testing the Fuse

The fuse is tested automatically:

- When the instrument is switched on with the rotary switch in the A position
- When the instrument is already on and the rotary switch is turned to the A position
- In the active current measuring range when voltage is applied

If the fuse is blown or has not been inserted, “FuSE” appears at the digital display. The fuse interrupts the current measuring ranges. All other measuring ranges remain functional.



Replacing the Fuse

If a fuse should blow, eliminate the cause of overload before placing the instrument back into service!



Attention!

Disconnect the instrument from the measuring circuit before opening the fuse cover in order to replace the fuse!

- ⇨ Set the instrument face down onto the working surface.
- ⇨ Turn the slotted screw on the cover with the fuse symbol counterclockwise.
- ⇨ Lift off the cover and pry the fuse out using the flat side of the fuse cover.
- ⇨ Insert a new fuse. Make sure that the fuse is centered, i.e. between the tabs at the sides.
- ⇨ When replacing the fuse cover, insert the side with the guide hooks first. Tighten the screw by turning it clockwise.
- ⇨ Dispose of the blown fuse with the trash.



Attention!

Use specified fuses only!

If fuses with other blowing characteristics, other current ratings or other breaking capacities are used, the operator is placed in danger, and protective diodes, resistors and other components may be damaged.

The use of repaired fuses or short-circuiting the fuse holder is prohibited.



Note

Testing the Fuse with the Instrument Switched On

After inserting the fuse with the instrument switched on, the instrument must be switched off briefly and then switched back on, or briefly switched to a non current measuring range and then back to the A measuring range.

If contact is poor or the fuse is blown, FUSE appears at the display.

10.4 Housing Maintenance

No special maintenance is required for the housing. Keep outside surfaces clean. Use a slightly dampened cloth for cleaning. Avoid the use of cleansers, abrasives or solvents.

10.5 Return and Environmentally Sound Disposal

The **instrument** is a category 9 product (monitoring and control instrument) in accordance with ElektroG (German electrical and electronic device law). This device is subject to the RoHS directive. Furthermore, we make reference to the fact that the current status in this regard can be accessed on the Internet at www.gossenmetrawatt.com by entering the search term WEEE.

We identify our electrical and electronic devices in accordance with WEEE 2012/19/EU and ElektroG with the symbol shown at the right per DIN EN 50419.



These devices may not be disposed of with the trash.

Please contact our service department regarding the return of old devices (see chapter Standard Equipment – Contact Persons).

If you use **batteries** or **rechargeable batteries** in your instrument or accessories which no longer function properly, they must be duly disposed of in compliance with the applicable national regulations.

Batteries or rechargeable batteries may contain harmful substances or heavy metal such as lead (Pb), cadmium (Cd) or mercury (Hg).

The symbol shown to the right indicates that batteries or rechargeable batteries may not be disposed of with the trash, but must be delivered to collection points specially provided for this purpose.



10.6 Recalibration

The respective measuring task and the stress to which your measuring instrument is subjected affect the ageing of the components and may result in deviations from the guaranteed accuracy.

If high measuring accuracy is required and the instrument is frequently used in field applications, combined with transport stress and great temperature fluctuations, we recommend a relatively short calibration interval of 1 year. If your measuring instrument is mainly used in the laboratory and indoors without being exposed to any major climatic or mechanical stress, a calibration interval of 2-3 years is usually sufficient.

During recalibration* in an accredited calibration laboratory (DIN EN ISO/IEC 17025) the deviations of your instrument in relation to traceable standards are measured and documented. The deviations determined in the process are used for correction of the readings during subsequent application.

We are pleased to perform DAkkS or factory calibrations for you in our calibration laboratory. Please visit our website at www.gossenmetrawatt.com (→ Company → DAkkS Calibration Center *or* → FAQs → Calibration questions and answers).

By having your measuring instrument calibrated regularly, you fulfill the requirements of a quality management system per DIN EN ISO 9001.

* Verification of specifications or adjustment services are not part of the calibration. For products from our factory, however, any necessary adjustment is frequently performed and the observance of the relevant specification is confirmed.

10.7 Manufacturer's Guarantee

All METRAHIT digital multimeters and calibration instruments are guaranteed for a period of 3 years after shipment. The manufacturer's guarantee covers materials and workmanship. Damages resulting from use for any other than the intended purpose or operating errors, as well as any and all consequential damages, are excluded.

The calibration certificate confirms that the product conformed to the specified technical data at the time of calibration. We guarantee the observance of the specified technical data within the admissible tolerance limits for a period of 12 months from delivery.

11 Accessories (Standard Equipment See Page 2)

11.1 General

The extensive accessories available for our measuring instruments are checked for compliance with currently valid safety regulations at regular intervals, and are expanded as required for new applications. Currently up-to-date accessories which are suitable for your measuring instrument are listed at the following web address along with photo, order number, description and, depending upon the scope of the respective accessory, data sheet and operating instructions: www.gossenmetrawatt.de (→ Products → Measuring Technology – Portable → Digital Multimeters → **METRAHIT** | ... → Multimeter Accessories).

11.2 Technical Data for Measurement Cables (scope of delivery: KS21-T safety cable set)

Electrical Safety

Maximum Rated Voltage	1000 V	1000 V
Measuring Category	CAT III	CAT II
Maximum Rated Current	1 A	16 A
with safety cap applied	•	—
without safety cap applied	—	•

Please observe the maximum values of the electrical safety of the device.

Ambient Conditions (EN 61 010-031)

Temperature –20 °C ... + 50 °C
Relative humidity 50 to 80%
Fouling factor 2

Application KS21-T



Attention!

In conformity with standard DIN EN 61010-031, measurements in an environment according to measuring category III may only be performed with the safety cap applied to the test probe of the measurement cable.

For establishing contact in 4 mm jacks you have to remove the safety cap by levering out the snap lock of the safety cap with another sharp object (e.g. the second test probe).

11.3 Power Pack NA X-TRA

Use only power packs from GMC-I Messtechnik GmbH only in combination with your instrument. This assures operator safety by means of an extremely well insulated cable, and safe electrical isolation (nominal secondary ratings: 5 V / 600 mA). Installed batteries are disconnected electronically if the power pack is used, and need not be removed from the instrument.

11.4 Interface Accessories

USB X-TRA Bidirectional Interface Adapter

This adapter makes it possible to connect cable multimeters, as well as **METRAHIT | X-TRA** multimeters which are equipped with a serial IR interface, to the USB port at a PC. The adapter allows for data transmission between the multimeter and the PC.

METRAwin 10 PC Analysis Software

METRAwin 10 PC software is a multilingual, measurement data logging program* for recording, visualizing, evaluating and documenting measured values from **METRAHIT |** multimeters.

Details on the system requirements are given in the installation instructions of **METRAwin 10/METRAwin 45**.

* runs under any IBM compatible Windows operating system

12 Index

Numerics

0.diSP 54

A

A.diSP 55

Addr 59

APoFF 55

Automatic Shutdown

 Disable 17

 Specify Time 17

Auto-Range Function 18

B

bAtt 54

Batteries

 Charge Level 68

 Level Indicator 13

 Periods of Non-Use 68

 Replacement 69

bEEP 55

C

Cable Length Measurement 35

Cable length measurement 47

Cable Resistance 31

Capacitance Measurement 35

Clip-On Current Sensor 39, 40

Continuity Test 33

Current Measurement

 Notes 36

D

dAtE 54, 56

Default Settings 57

Device Returns 70

Diode Test 34

Discharging 46

Display Illumination 16

E

Error 46

Error Messages 68

F

Fuse

 Replacement 69

I

Interfaces

 Accessories 73

 Statuses 13

Interference Voltage Detection 46

irStb 59

M

Maintenance

 Housing 70

Manufacturer's Guarantee 71

Measured Value Storage

 DATA Function 21

 MIN/MAX Values 22

Measurement Cables 72

Measuring Category

 Significance 8

Measuring Range Selection

 Automatic 18

 Manual 18

Memory

 Clear 24

 Ending Recording 24

 Querying Occupancy 24

 Start Recording 23

O

OCCUP 54

Overview

 Keys and Connections 12

 Parameters 53

P

Polarity Reversal 45

Power Pack

 Accessories 72

 Initial Start-Up 16

Power Pack Adapter Socket

 Position of the Connector Socket 15

Product Support 3

Product Support Hotline 3

R

rAtE 54

Recalibration Service 4, 71

Repair and Replacement Parts Service 4

Resistance Measurement 30

S	
Safety Precautions	8
Scaling Factor	35
Scaling factor	47
Software Enabling	3
Standard Equipment	2
Switching the Instrument On	
Manual	16
Via PC	16
Symbols	
Device	15
Digital Display	13
Rotary Switch Positions	14
T	
Temperature Measurement	
With Resistance Thermometers	31
tiME	54, 56
U	
Under-Range	18
ur (under-range)	46, 68
Use for Intended Purpose	10
V	
vErSion	54
Voltage Comparator	29
Voltage Measurement	
Notes	26
W	
WEEE Mark	15

Edited in Germany • Subject to change without notice • A pdf version is available on the internet

 **GOSSEN METRAWATT**
GMC-I Messtechnik GmbH
Südwestpark 15
90449 Nürnberg • Germany

Phone +49 911 8602-111
Fax +49 911 8602-777
E-Mail info@gossenmetrawatt.com
www.gossenmetrawatt.com