

Signet 9950 Dual Channel Transmitter



Member of the SmartPro® Family of Instruments



The 9950 Transmitter is a two channel controller that can support two sensors of same or different types in one instrument. The sensor types supported by the 9950 are Signet Flow, pH/ORP, Conductivity/Resistivity, Salinity, Temperature, Pressure, Level, Dissolved Oxygen, and devices that transmit a 4 to 20 mA signal with the use of the 8058 iGo® Signal Converter.

The 9950 includes advanced features such as derived functions, advanced multiple relay modes, and timer based relay functions. Derived functions allows for the control of a relay or current loop with the sum, delta (difference), or ratio of two measurements, for example delta pressure and delta temperature. Multiple relay modes allow up to three signals to be used for the control of a single relay. This can be any combination of analog and binary inputs. The timer relay modes allow relay to be activated on a repeating basis from every minute to once every 30 days. Weekday timer mode allows a relay to be turned on on a specific day or days of the week at a specific time.

The 3-9950.393-3 Relay Module includes the ability to interface up to four binary inputs. The binary inputs are compatible with either open collector or mechanical contacts. The binary inputs can supply power to the four inputs or accepts powered outputs from external devices. These inputs can be used with level switches, flow switches, pressure switches or other devices. The inputs can be used to directly control the relays of the 9950 or can be used in combination with the measurement readings for advanced control of your process.

The 9950 supports the following relay modules:

- Four Channel Mechanical Relay Module
- Two Mechanical and Two Solid State Relay Module
- Two Mechanical Relays and Four Binary Inputs Module

Features

- One instrument for multiple sensor types
- Two different sensor types can be combined in one unit
- Configurable display
- Derived measurements
- Advanced boolean logic
- Optional modules can be added for additional capabilities
- USB Port for Field Upgrades using standard USB Flash Drive



Applications

- Wastewater Treatment
- Reverse Osmosis
- Deionization
- Chemical Manufacturing / Addition
- Metal and Plastic Finishing
- Fume Scrubber
- Cooling Tower
- Media Filtration
- Chemical Dosing/ Injection
- Aquatic Life Support
- Pools & Fountains
- Rinse Tanks
- Chemical Neutralization

Specifications

General		
Input Channels	Two frequency or S ³ L inputs	
Enclosure and Display		
Case Material	PBT	
Window	Shatter-resistant glass	
Keypad	4 buttons, injection-molded silicone rubber seal	
Display	Dot matrix, LCD	
Indicators	Two horizontal digital bar graphs, four LED relay status indicators	
Update Rate	1 s	
LCD Contrast	5 settings	
Size	¼ DIN	
Mounting		
Panel	¼ DIN, ribbed on four sides for panel mounting clip inside panel, silicon gasket included	
Wall	Large enclosure (sold as an accessory)	
Terminal Blocks		
Pluggable Screw Type	Use minimum 105 °C rated wire	
Torque Ratings		
	Power/Loop	0.49 Nm (4.4 lb-in.)
	Freq/S ³ L	0.49 Nm (4.4 lb-in.)
	Relay Module	0.49 Nm (4.4 lb-in.)
Connector Wire Gauge		
	Power, Loop	12 to 28 AWG
	Freq/S ³ L	16 to 28 AWG
Relay Module Connector Wire Gauge		
	Relay	12 to 28 AWG
Environmental		
Ambient Operating Temperature		
DC Power	-10 °C to 70 °C	14 °F to 158 °F
AC Power	-10 °C to 60 °C	14 °F to 140 °F
Storage Temp	-15 °C to 70 °C	5 °F to 158 °F
Relative Humidity	0 to 100% condensing for (front only); 0 to 95% non-condensing (rear panel)	
Maximum Altitude	4,000 m (13,123 ft)	
Enclosure Rating	NEMA 4X/IP65 (front face only)	
Performance Specifications		
System Accuracy	Primarily dependent upon the sensor	
System Response	Primarily dependent upon the sensor. Controller adds a maximum of 150 ms processing delay to the sensor electronics.	
	Minimum update period is 100 ms	
	System response is tempered by the display rate, output averaging and sensitivity feature	

Specifications (continued)

Electrical Requirements	
Power to Sensors	
Voltage	+4.9 to 5.5 VDC @ 25 °C, regulated
Current	30 mA Maximum
Short Circuit	Protected
Isolation	Low voltage (< 48 V AC/DC)
Power Requirements	
DC (3-9950-1, 3-9950-2)	24 VDC nominal (10.8 to 35.2 VDC regulated)
AC (3-9950-2)	100 to 240 VAC, 50 to 60 Hz, 24 VA
Maximum current	200 mA (without optional relay module)*
	500 mA (with optional relay module)*
*The current draw of the other modules and the sensors are minimal	
Current Loop	10.8 to 35.2 VDC 4 to 20 mA (30 mA max.)
Overvoltage protection	48 Volt Transient Protection Device (for DC ONLY)
Current limiting for circuit protection	
Reverse-Voltage protection	
Input Types	
Digital (S ³ L) or AC frequency	
4 to 20 mA input via the 8058	
Open collector	
pH/ORP input via the Digital (S ³ L) output from the 2750 pH/ORP Sensor Electronics	
Conductivity/Resistivity via the Digital (S ³ L) output from the 2850 Conductivity/Resistivity Sensor Electronics	
Sensor Types	Flow, pH/ORP, Conductivity/Resistivity, Pressure, Temperature, Level/Volume, Salinity, Dissolved Oxygen, Other (4 to 20 mA)
Sensor Input Specifications	
Digital (S ³ L)	Serial ASCII, TTL level, 9600 bps
Frequency Flow Sensors	0.5 to 1500 Hz
Sensitivity (for coil type sensors)	80 mV @ 5 Hz, gradually increasing with frequency to 2.5 V
Freq. Range (for square wave type sensors)	0.5 Hz to 1500 Hz @ TTL level input or open collector
K-Factor Range	0.0001 to 9999999
Accuracy	± 0.5% of reading max error @ 25 °C
Resolution	1 µs
Repeatability	± 0.2% of reading
Power Supply	
Rejection	No Effect ± 1 µA per volt
Short Circuit	Protected
Reverse Polarity	Protected
Update Rate	(1/frequency) + 100 ms

Specifications (continued)

Binary Input (3-9950.393-3)

Input Voltage Range (without damage)	-5 VDC to 30 VDC (No operation below 0 VDC)		
Max. Current Rating	6.0 mA		
Max. Voltage Rating	30 VDC		
Maximum Input Voltage for signal "Off" (low or "0")	3.0 VDC		
Minimum Input Voltage for signal "On" (high or "1")	4.8 VDC		
Maximum Current Draw for Signal "0" (low)	≤ 500 µA DC		
Minimum Current Draw for Signal "1" (high)	750 µA		
Typical Current Draw for Signal "1" (high)	6.0 mA at 30 VDC, 4.8 mA at 24 VDC, 2.4 mA at 12 VDC, 1.0 mA at 5 VDC		

Current Loop Specifications

Current Loop Out	ANSI-ISA 50.00.01 Class H (Passive, external voltage required)		
Voltage	10.8 to 35.2 VDC		
Max. Impedance	250 Ω @ 12 VDC	500 Ω @ 18 VDC	750 Ω @ 24 VDC
Span	3.8 to 21 mA		
Accuracy	± 32 µA max. error @ 25 °C @ 24 VDC		
Resolution	6 µA or better		
Temp. Drift	± 1 µA per °C		
Isolation	Low voltage (< 48 VAC/DC)		
Update Rate	100 mS nominal		
Zero	4.0 mA factory set; user programmable from 3.8 to 5.0 mA		
Full Scale	20.0 mA factory set; user programmable from 19.0 to 21.0 mA		
Power Supply Rejection	± 1 µA per V		
Actual Update Rate Determined by Sensor Type			
Short Circuit and Reverse Polarity Protected			
Adjustable Span, Reversible			
Error Condition	Selectable error condition 3.6 or 22 mA or None		
Test Mode	Increment to desired current (range 3.8 to 21.00 mA)		
Analog Outputs	2 Passive 4 to 20 mA Outputs in Base Unit		

Relay Specifications

Dry-Contact Relays (3-9950.393-1, 3-9950.393-2, and 3-9950.393-3)

Type	SPDT
Form	C
Max. Voltage Rating	30 VDC or 250 VAC
Max. Current Rating	5 A resistive

Solid-State Relays (3-9950.393-2)

Type	SPDT
Form	C
Max. Voltage Rating	30 VDC or 30 VAC
Max. Current Rating	0.050 A resistive

Hysteresis	Adjustable (absolute in Engineering Units)
On Delay	9999.9 seconds (max)
Cycle Delay	99999 seconds (max)
Test Mode	Set On or Off
Maximum Pulse Rate (PLC and Counters)	300 pulses/minute
Proportional Pulse (Metering Pumps)	300 pulses/minute
Volumetric Pulse Width	0.1 to 3200 s
PWM Period (Solenoid Valves)	0.1 to 320 s

Specifications (continued)

Display Ranges		
pH	-1.00 to 15.00 pH	
pH Temp.	-99 °C to 350 °C	-146 °F to 662 °F
ORP	-1999 to +1999.9 mV	
Flow Rate	-9999 to 99999 units per second, minute, hour or day	
Totalizer	0.00 to 99999999 units	
Conductivity	0.0000 to 99999 µS, mS, PPM and PPB (TDS), kΩ, MΩ	
Cond. Temp.	-99 °C to +350 °C	-146 °F to 662 °F
Temperature	-99 °C to +350 °C	-146 °F to 662 °F
Pressure	-40 to 1000 psi	
Level	-9999 to +99999 m, cm, ft, in, %	
Volume	0 to 99999 cm ³ , m ³ , in ³ , ft ³ , gal, L, lb, kg, %	
Salinity	0 to 100 PPT	
Dissolved Oxygen	0 to 50 mg/L, 0 to 200%	
Shipping Weights		
Base Unit	0.63 kg	1.38 lb
Relay Module	0.19 kg	0.41 lb
Standards and Approvals		
CE, UL, CUL, FCC		
RoHS Compliant, China RoHS		
Manufactured under ISO 9001 and ISO 14001 for Environmental Management and OHSAS 18001 for Occupational Health and Safety		

Dimensions

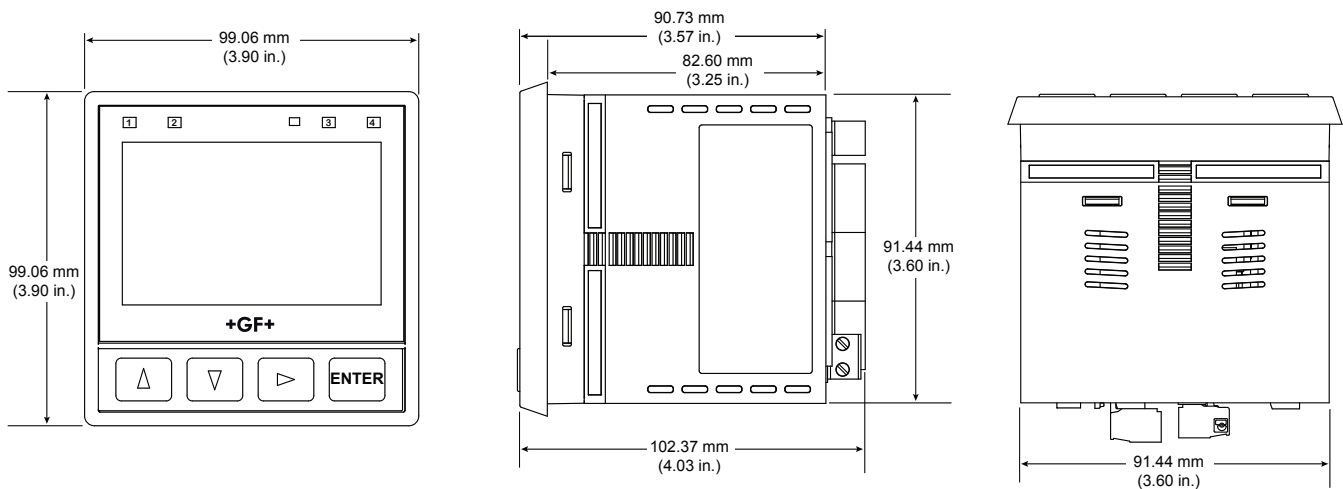

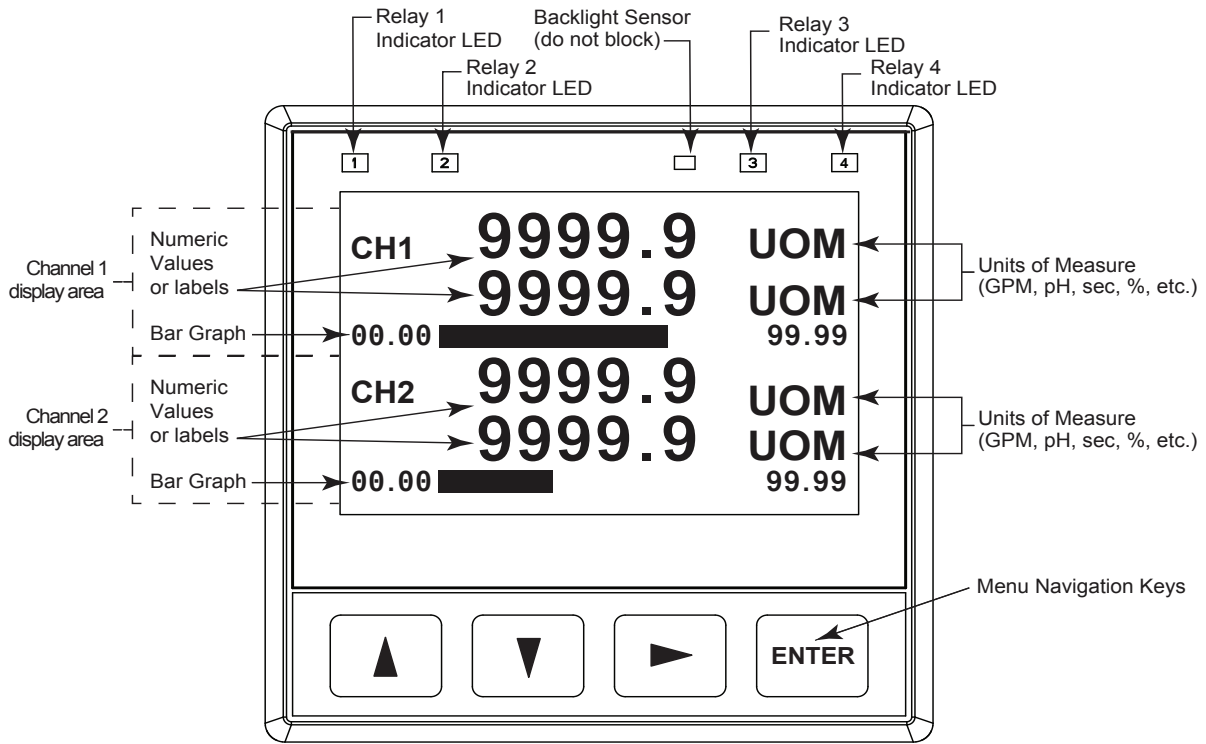

The 9950 is compatible with all GF Signet products listed in the column to the right.

- pH and ORP electrodes require the Signet 2750 DryLoc® Sensor Electronics (sold separately).
- Conductivity/Resistivity or measurement requires the Signet 2850 Conductivity/Resistivity sensor electronics (sold separately).

Sensor Model	Freq Output	Digital (S ³ L) Output	Requires 8058
515/8510	X		
525	X		
2000	X		
2100	X		
2250		X	
2350		X	
2450		X	
2507	X		
2536/8512	X		
2537-5		X	
2540	X		
2551	X	X	
2552	X	X	
U1000	X		X
U3000	X		X
U4000	X		X
2260			X
2270			X
2290			X
2291			X
2610-41		X	
2724-2726		X	
2734-2736		X	
2750		X	
2756-2757		X	
2764-2767		X	
2774-2777		X	
2819-2823		X	
2839-2842		X	
2850		X	

Binary Input compatible sensors. For use with
3-9950.393-3 Relay Module

Sensor Model	Binary Input
2280	X
2281	X
2282	X
2284	X
2285	X

System Overview

Panel or Wall Mount

Signet Model 9950 Transmitter
(Includes mounting bracket and panel gasket)



Signet Sensors - Flow, Level, Temperature, Pressure, DO
Use one input from sensor options below

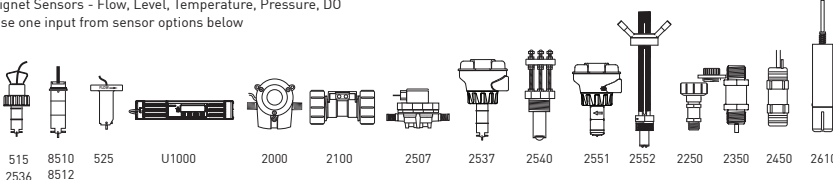

515 8510 525 U1000 2000 2100 2507 2537 2540 2551 2552 2250 2350 2450 2610

Other Level with 8058 iGo Converter
plus other 4 to 20 mA

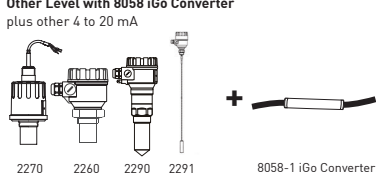

2270 2260 2290 2291 8058-1 iGo Converter

Signet Sensors - pH/ORP
Use one input from sensor options below
with 2750 Sensor Electronics

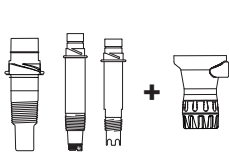

+

Signet Wet-Tap Electrode Model 2756, 2757 and
3719 Wet-Tap with 2750 Sensor Electronics

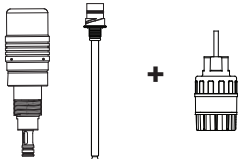

+



Signet Sensors - Conductivity/Resistivity and Salinity Electrodes
Use one input from electrode options below
with Conductivity Module or 2850 Sensor Electronics

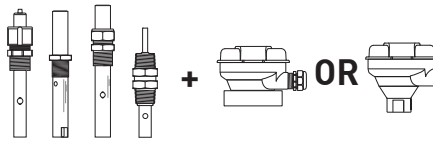

+

OR



Signet Fittings - See individual sensor data sheets All sold separately

Ordering Information

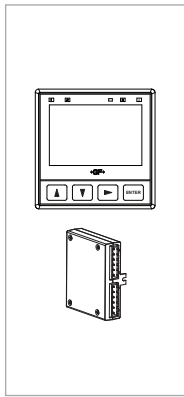

Mfr. Part No	Code	Description
9950 Base Unit - Dual Channel, Multi-Parameter, AC Power and DC Power		
3-9950-1	159 001 841	9950 Base Unit – Two Channel Multi-Parameter Inputs, Two 4 to 20 mA Outputs, Panel Mount, DC Power
3-9950-2	159 001 842	9950 Base Unit – Two Channel Multi-Parameter Inputs, Two 4 to 20 mA Outputs, Panel Mount, AC or DC Power
Optional Accessory Modules		
3-9950.393-1	159 310 268	Relay Module with 4 Mechanical Relays
3-9950.393-2	159 310 269	Relay Module with 2 Mechanical and 2 Solid State Relays
3-9950.393-3	159 310 270	Relay Module with 2 Mechanical Relays and 4 Binary Inputs

Accessories and Replacement Parts

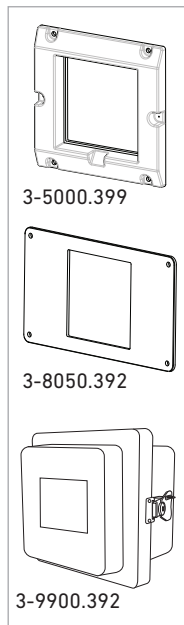

Mfr. Part No	Code	Description
7310-1024	159 873 004	24 VDC Power Supply, 10 W, 0.42 A
7310-2024	159 873 005	24 VDC Power Supply, 24 W, 1.0 A
7310-4024	159 873 006	24 VDC Power Supply, 40 W, 1.7 A
7310-6024	159 873 007	24 VDC Power Supply, 60 W, 2.5 A
7310-7024	159 873 008	24 VDC Power Supply, 96 W, 4.0 A
3-5000.399	198 840 224	5 x 5 inch Retrofit Adapter
3-8050.392	159 000 640	CR200 ¼ DIN Retrofit Adapter
3-8050.396	159 000 617	RC Filter Kit (for relay use), 2 per kit
3-8058-1	159 000 966	i-Go® Signal Converter, wire-mount
3-9950.391	159 310 278	Connector Kit, In-Line, 9950 Transmitter
3-9950.392	159 310 279	Relay Module Connector Kit, 9950 Transmitter
3-9900.392	159 001 700	Wall Mount Enclosure Kit
3-9000.392-1	159 000 839	Liquid Tight Connector Kit, NPT (1 pc.)