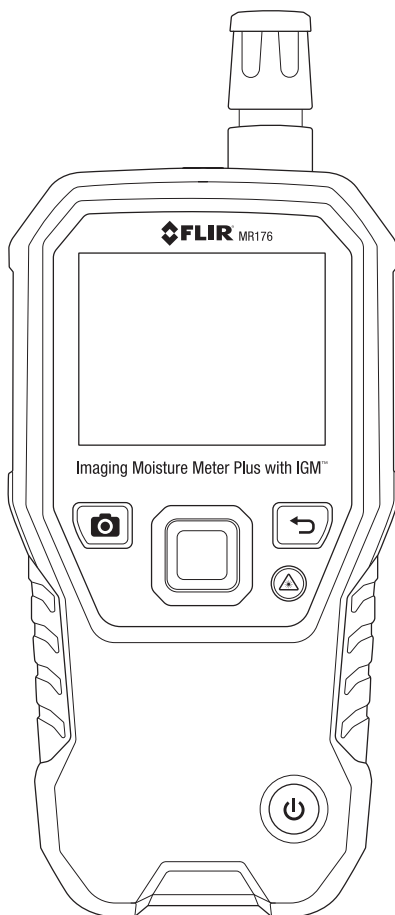


**FLIR MODEL MR176****IMAGING MOISTURE METER PLUS  
with IGM™**

# Table of Contents

---

<b>1. DISCLAIMERS</b>	<b>4</b>
1.1 Copyright	4
1.2 Quality Assurance	4
1.3 Documentation	4
1.4 Disposal of Electronic Waste	4
<b>2. SAFETY</b>	<b>5</b>
2.1 Safety Notes	5
2.2 Laser Safety	5
<b>3. INTRODUCTION</b>	<b>6</b>
3.1 Key Features	6
<b>4. METER AND MENU ICON DESCRIPTIONS</b>	<b>7</b>
4.1 Meter Parts	7
4.2 Control Buttons	8
4.3 Menu Map and Overview	9
<b>5. OPERATION</b>	<b>10</b>
5.1 Powering the Meter	10
5.1.1 Auto Power OFF (APO)	10
5.2 Moisture Measurements	10
5.2.1 Moisture Measurement Overview	10
5.2.2 Moisture Displays Overview	11
5.2.3 IMAGE Modes	12
5.2.4 MOISTURE Modes	13
5.2.5 Internal Moisture Sensor Measurements (Pinless)	14
5.2.6 External Pin Probe Moisture Measurements	14
5.2.7 Reference Mode Moisture Measurements	15
5.3 Thermal Imager (IR)	15
5.4 Lock/Unlock Palette Auto-Scale Mode	17
5.5 Screen Capture and Hold	18
5.6 Progressive Environmental Stability Indicator	18
5.7 'Combination' Feature: Save Thermal Image with Pinless Moisture Reading	19

5.8 High Moisture Alarm	20
5.9 SETTINGS Menu	20
<b>6. MAINTENANCE</b>	<b>22</b>
6.1 Cleaning	22
6.2 Battery Charging	22
6.2.1 Disposal of Electronic Waste	22
6.3 Updating the MR176 firmware	23
<b>7. SPECIFICATIONS</b>	<b>24</b>
<b>8. TECHNICAL SUPPORT</b>	<b>26</b>
<b>9. MATERIAL GROUPS</b>	<b>27</b>
9.1 Common Names of Timbers (BS888/589:1973) with MR176 Group Nos.	27
9.2 Botanical names of timbers with MR176 program group numbers	29
9.3 %WME Table (% Wood Moisture Equivalent)	31
<b>10. WARRANTY</b>	<b>32</b>
10.1 FLIR Test & Measurement 2 year/10 year Limited Warranty	32

# 1. Disclaimers

---

## 1.1 Copyright

© 2015, FLIR Systems, Inc. All rights reserved worldwide. No parts of the software including source code may be reproduced, transmitted, transcribed or translated into any language or computer language in any form or by any means, electronic, magnetic, optical, manual or otherwise, without the prior written permission of FLIR Systems.

The documentation must not, in whole or part, be copied, photocopied, reproduced, translated or transmitted to any electronic medium or machine readable form without prior consent, in writing, from FLIR Systems.

Names and marks appearing on the products herein are either registered trademarks or trademarks of FLIR Systems and/or its subsidiaries. All other trademarks, trade names or company names referenced herein are used for identification only and are the property of their respective owners.

## 1.2 Quality Assurance

The Quality Management System under which these products are developed and manufactured has been certified in accordance with the ISO 9001 standard.

FLIR Systems is committed to a policy of continuous development; therefore we reserve the right to make changes and improvements on any of the products without prior notice.

## 1.3 Documentation

To access the user manuals, extended warranty registration, firmware updates, and notifications go to the Download tab at: <http://support.flir.com>. In the download area you will also find the latest releases of manuals for our other products, as well as manuals for our historical and obsolete products. The extended warranty page can also be found at [www.Flir.com/testwarranty](http://www.Flir.com/testwarranty).

## 1.4 Disposal of Electronic Waste



As with most electronic products, this equipment must be disposed of in an environmentally friendly way, and in accordance with existing regulations for electronic waste.



Please contact your FLIR Systems representative for more details.

## 2. Safety

---

### 2.1 Safety Notes

- Before operating the device, you must read, understand, and follow all instructions, dangers, warnings, cautions, and notes.
- FLIR Systems reserves the right to discontinue models, parts or accessories, and other items, or to change specifications at any time without prior notice.

### 2.2 Laser Safety

#### Warning Statement

- Do not look directly into the laser beam. The laser beam can cause eye irritation.



### 3. Introduction

---

Thank you for selecting the FLIR MR176 Imaging Moisture Meter. The MR176 integrates high quality thermal imaging technology with the best in class moisture detection and measurement. The MR176 includes an integrated non-invasive pinless moisture sensor, an external pin moisture probe (MR02), and a replaceable temperature and relative humidity sensor (MR01) that provides dew point, vapor pressure, and mixing ratio readings in addition to air temperature and relative humidity.

Featuring **Infrared Guided Measurement (IGM™)** technology, the MR176 helps to quickly scan and target moisture issues; visually guiding the user to the spot where measurements can be confidently made and where readings can be easily analyzed. The MR176 can save measurements and images for later transfer to a PC; reports can be generated with FLIR Tools PC software. Please see [www.flir.com/test](http://www.flir.com/test) for additional accessories available for this device. This device is shipped fully tested and calibrated and, with proper use, will provide years of reliable service.

Please register the FLIR MR176 within 60 days of purchase for extended warranty at the following location: [www.flir.com/testwarranty](http://www.flir.com/testwarranty)

#### 3.1 Key Features

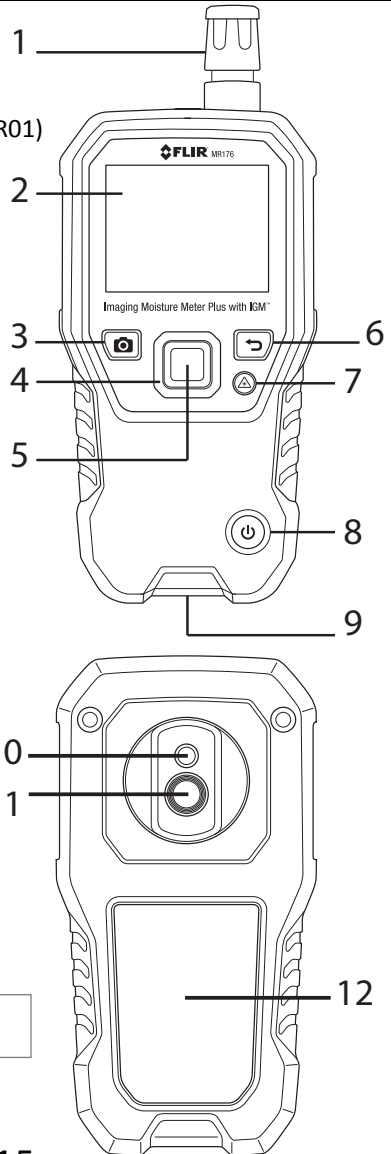
- FLIR Lepton® microbolometer Focal Plane Array (FPA) with integrated shutter delivers best in class thermal imaging
- Quickly scan for moisture using the integrated non-invasive pinless moisture sensor
- External pin probe (included) for resistive moisture content measurements
- Ambient air temperature and relative humidity readings from field replaceable sensor
- IGM Custom mode allows user to select a which measurements (Moisture and Psychrometrics) are displayed with the IR thermal image
- IGM Moisture mode displays both the thermal image and moisture readings on one screen
- Psychrometrics mode shows ambient air temperature, relative humidity (RH%), dew point, mixing ratio, and vapor pressure all on one screen
- Moisture mode shows Pin or Pinless moisture readings with large digits and color bargraph
- Scale Lock adds precision to thermal image scanning
- Capture, view, & delete thermal images and measurements
- Nine (9) material group selections for pin-based readings
- Programmable high moisture alarm with audible and color visual alerts
- Laser pointer and display crosshairs for targeting of anomalies found on thermal image
- Easy to read, color display with intuitive graphical interface and tool tips in local languages
- File management, image review, & report generation with free FLIR Tools PC software via USB
- Internal rechargeable battery with USB based international charger

**Register for Extended Warranty:** [www.Flir.com/testwarranty](http://www.Flir.com/testwarranty)

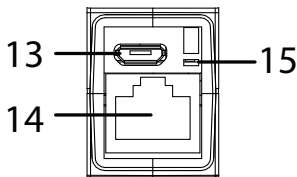
## 4. Meter and Menu Icon Descriptions

### 4.1 Meter Parts





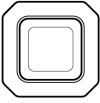
1. Temperature and Relative Humidity Sensor (MR01)
2. Color Graphical Display
3. Screen Capture button
4. Four (4) Navigation buttons (ring)
5. Select button (center)
6. Back button
7. Laser Pointer / Crosshairs button
8. Power button
9. USB, External Probe jack, and charge LED
10. Laser pointer lens (back)
11. Thermal imaging lens (back)
12. Internal Pinless Moisture sensor (back)
13. Micro USB Port (bottom)
14. External Probe Jack (bottom)
15. Battery Charging LED status lamp (bottom)



**Fig. 4-1** Meter Description



## 4.2 Control Buttons

	Image Capture button: Press to save a 'screen-shot'. Refer to section 5.5 <i>Screen Capture and Hold</i> for full details.
	Back button. Press to back up or return from a menu screen.
	Press to activate laser pointer/crosshairs in thermal imaging modes.
	Press to power the meter ON. Press and hold to power the meter OFF.
	Press the Select button (center) to access the Main Menu. Use this button to select items from within the menu structure. Use the four outer navigation (rim) buttons to move up-down-left-right.



## 4.3 Menu Map and Overview

The Menu structure is outlined below and covered thoroughly in subsequent sections of this User Guide. The center Select button and the four (4) Navigation buttons are used to access and program the modes of operation available from the menus. Refer to Fig. 4-2.

Icons 1 through 5 in Fig. 4-2 make up the **Main Menu**. Press the Select button to open the Main Menu:

1. Image Review: view and delete IR Thermal Images
2. Image modes (items 10~14): IR, IGM Custom, IGM Moisture, Psychrometrics, Moisture
3. Moisture modes: Material Groups, Pin Mode, Pinless Mode, Set Reference
4. Lock/Unlock Palette Auto-Scale: Select Lock to adjust the color palette range to suit a given application (see Section 5.4 *Lock/Unlock Palette Auto-Scale Mode* for more detail). Unlock for normal auto-scaling operation.
5. Settings utility: Language, Configure IGM Custom, Palette, High Alarm, Auto Power OFF, Temperature units, Date & Time, Help contact screen, and Meter Information screen.

Icons 6 through 9 in Fig. 4-2 are available in the **Moisture Mode Menu**. Press icon 3 to view these Moisture modes. A blue dot is shown to the left of the pin icon (7) or the pinless icon (8), depending on which is selected.

6. Material Group: Select the material under test (Groups 1~9); For Pin Mode only. See Section 9 for Wood and Material Group listings.
7. Pin mode: Select this mode when using external pin moisture probe.
8. Pinless mode: Select this mode when using the internal (rear) moisture sensor.
9. Set Reference: Select this mode to store the current reading as a reference value. For pinless mode only.

Icons 10 through 14 in Fig. 4-2 are available in the **Image Mode Menu**. Press icon 2 to view the Image Mode menu.

10. IR (View Thermal Image only)
11. IGM Custom (View Thermal Image + selected Psychrometrics)
12. IGM Moisture (View Thermal Image + Moisture readings)
13. Moisture + Psychrometrics (Air Temperature, RH%, Dew point, Mixing ratio, Vapor pressure views)
14. Moisture (Digital + Bargraph reading with Alarm, Material Group, & Relative values)

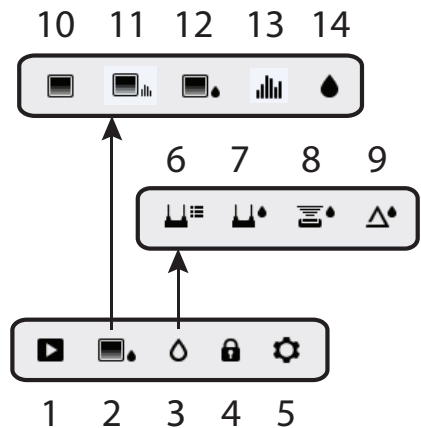



Fig. 4-2 Menu Icons

## 5. Operation


---

**Important Note:** Please charge the meter's battery before first use. Instructions for battery charging are provided in Section 6.2.

### 5.1 Powering the Meter

1. Press the Power button  momentarily to switch the meter ON.
2. Press and hold the Power button for > 1 second to switch the meter OFF.
3. If the battery status indicator shows that the battery voltage is low, or if the meter does not power on, charge the battery. See section 6.2 *Battery Charging*. The battery status indicator is visible in the Main Menu (press the center Select button to access the Main Menu).
4. Please fully charge the battery before use.

#### 5.1.1 Auto Power OFF (APO)

The meter switches OFF automatically after a programmed period of inactivity. Press any button to reset the APO timer. To disable APO, or to change the APO time-out value, use the Settings  mode, accessible from the Main Menu. The default time-out is 20 minutes.

### 5.2 Moisture Measurements

#### 5.2.1 Moisture Measurement Overview

Moisture measurements can be performed using either the internal pinless moisture sensor (rear) or by connecting an external probe. A standard external pin probe is included which connects to the MR176 via the jack at the bottom of the meter. Other external probes are available; please visit [www.flir.com/test](http://www.flir.com/test) for details.


**NOTE:** Objects in close proximity to the internal pinless moisture sensor (located on the rear of the unit) will affect the reading on the display; Keep hands and fingers clear of the sensor when taking measurements.


The internal moisture sensor detects moisture to a depth of approximately 19mm (0.75"). The actual depth will vary depending upon the amount of moisture, the material under test, surface roughness, and other factors.

Moisture readings are shown on the display (digitally and with bar graph) in the Moisture-only mode or in small digits (upper left hand corner) in the IGM Custom and IGM Moisture modes. See Fig. 5-1. Pinless measurement readings are 'relative' scaled (0~100). Pin-based readings are represented in terms of %MC (moisture content) for wood and %WME (wood moisture equivalent) for non-wood materials; additional information is provided in Section 5.2.6 *External Pin Probe Moisture Measurements* and in the specifications.

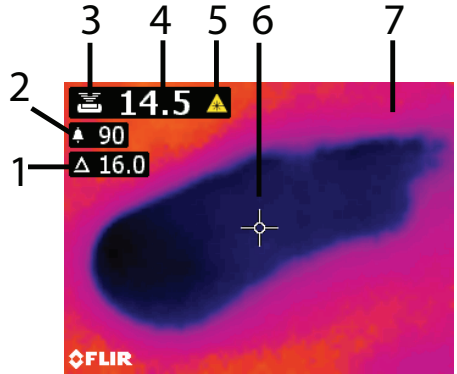
Moisture measurements are covered in detail in the following sections. Be sure to select Pin Mode or Pinless Mode in the Moisture Menu to match the measurement type.


## 5.2.2 Moisture Displays Overview

There are three modes where moisture readings are displayed; refer to Figs. 5-1 (a) through (c) for a description of each. To access the modes shown below, press the Select button after navigating to the Image Mode icon  in the Main Menu. Then use the navigation buttons to scroll to the desired mode; press Select again to confirm.

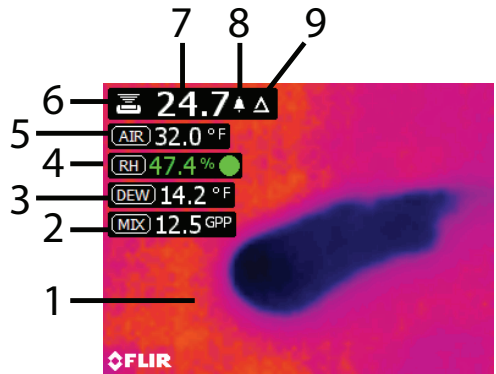
**Fig. 5-1(a)** IGM Moisture Image Mode 

1. Relative icon and reference value
2. Alarm icon and Alarm Threshold value
3. Mode icon (pinless mode selected)
4. Moisture reading
5. Laser pointer icon
6. Cross-hairs
7. Thermal image

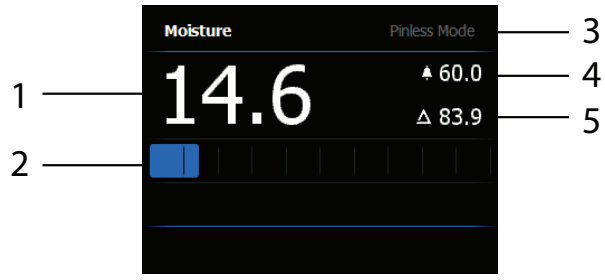


**Fig. 5-1(b)** IGM Custom Image Mode 

1. Thermal image
2. Mixing ratio
3. Dew point temperature
4. Relative Humidity (solid green dot & green reading when stabilized)
5. Air Temperature reading
6. Mode icon (pinless mode selected)
7. Moisture reading
8. Alarm icon
9. Relative mode icon



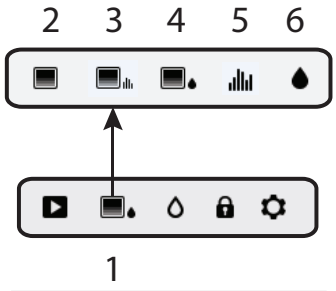
1. Moisture reading (digital)
2. Moisture reading (bargraph); Bars are blue in color when in non-alarm state and red when in an alarm state.
3. Selected Moisture Mode
4. High Moisture Alarm threshold (see Section 5.8)
5. Set Reference value (see Set Reference mode in Sections 5.2.3 and 5.2.6); pinless mode only. Note that in Pin mode this display area will show the selected Material/Wood Group. Access the Moisture Mode to select the Material/Wood Group.







**Fig. 5-1(c) Moisture-only Mode** 

### 5.2.3 IMAGE Modes


Press the Select button to access the Main Menu and then select the IMAGE mode icon (1). Refer to Fig. 5-2. Choose Thermal IR Image-only mode (2), IGM Custom mode, (3), IGM Moisture mode (3), Psychrometrics mode (4), or Moisture-only mode (4). Each mode is described below.




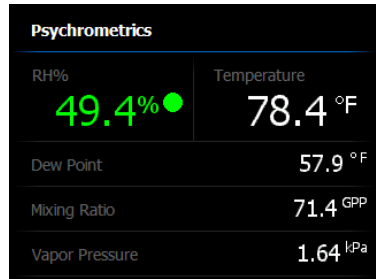
**Fig. 5-2 Image mode**

1. Image mode icon in the Main Menu 
2. IR Thermal Image mode only   
In the IR mode the meter displays only the IR Thermal Camera image. See Fig. 5-7
3. IGM Custom mode   
In the IGM Custom mode the meter displays the IR Thermal Camera image with superimposed measurement fields for Moisture, Air Temperature, Relative Humidity, Dew Point Temperature, Mixing Ratio, and Vapor Pressure. In the Settings menu, the user can choose which of these parameters to view. See Fig. 5-1(b).
4. IGM Moisture mode 

In the IGM Moisture mode the meter displays the IR Thermal Camera Image and the moisture reading text (upper left hand corner) and the pin or pinless mode icon (depending on which is currently selected). See Fig. 5-1(a).

5. Psychometrics mode 

In the Psychometrics mode the IR Thermal Camera Image is off and the meter displays all parameters except moisture (Air Temperature, RH%, Dew Point Temperature, Mixing Ratio, and Vapor Pressure). See Fig. 5-3.
6. Moisture reading only 




**Fig. 5-3 Psychrometrics Screen**

In the Moisture only mode the IR Thermal Camera Image is off and the meter shows only the moisture reading in digits and in bargraph formats, see Fig. 5-1(c).

## 5.2.4 MOISTURE Modes

From the Main Menu select the MOISTURE mode icon (1). Refer to Fig. 5-4. Then choose from the four Moisture mode options (items 2, 3, 4, and 5) as described below.

1. Moisture Mode Icon from the Main Menu 

2. MATERIAL GROUPS 

Select a Material wood group that best matches the material under test. This applies only for external pin-based probe use; Use the navigation buttons to scroll through the group list and use the Select button to choose the group. The selected group will show a blue dot. See the Material Wood Group List Appendix in Section 9.

3. PIN MODE 

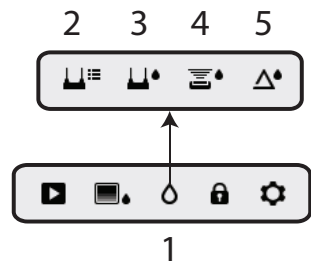
PIN mode must be selected when the external pin-based probe is used. Note the pin icon (3) on the upper left of the main display when selected.

4. PINLESS MODE 

PINLESS mode must be selected when using the internal sensor. Note the pinless icon (4) on the upper left of the main display when selected.

5. SET REFERENCE MODE 

SET REFERENCE is used to compare the displayed readings against a stored reference measurement (see Section 5.2.7 *Reference Mode*). This mode applies only to readings taken with the pinless internal sensor.



**Fig. 5-4 Moisture mode icons**

### 5.2.5 Internal Moisture Sensor Measurements (Pinless)

1. Follow the steps in Section 5.2.1 through 5.2.4 and select the Pinless mode.
2. Place the internal moisture sensor (back) on the surface of the material to be tested. Apply light pressure to ensure that the internal sensor is completely flat against the surface of the material under test.
3. The relative moisture reading is displayed on the main display in the upper left hand corner (IGM Custom or IGM Moisture modes) or as bargraph with accompanying digits (Moisture-only mode). Refer to example screens shown in Fig. 5-1.
4. Keep hands, surfaces, and objects away from the rear internal moisture sensor area when taking measurements.
5. For best results, lift the meter off of the surface under test between measurement points; do not drag the meter over surfaces.

### 5.2.6 External Pin Probe Moisture Measurements

1. Follow the steps in Section 5.2.1 through 5.2.4 and select Pin mode from the MOISTURE mode options.
2. Connect the external pin probe to the meter's EXT jack on the bottom of the meter (under the protective flap). Refer to the FLIR website for information on available external pin moisture probe types.
3. Select the appropriate Material Group as described in Section 5.2.4 (see Section 9 for the Material Group Appendices). Note: Use Group 9 for building materials.
4. Press the pins into the material under test.
5. The moisture reading is displayed on the main display (%) in the upper left hand corner (IGM Custom or IGM Moisture modes) or as a bargraph with accompanying digits (Moisture-only mode). Refer to example screens shown in Fig. 5-1.

#### Notes on External Pin Probe Moisture measurements





*The MR176 will display accurate external pin probe readings in the 7% to 30% range, depending on the tested material. Moisture Content readings below 6% will display as 0% for all materials and the maximum specified range is dependent on the fiber saturation point for specific species. Above the fiber saturation point, the reading can only be used as a relative reference value.*

*For more information on fiber saturation please refer to ASTM D7438. For additional information on Pin moisture measurement accuracy please see ASTM D4444, section 6.*

## 5.2.7 Reference Mode Moisture Measurements

1. Follow the steps in Section 5.2.1 through 5.2.4 and select SET REFERENCE from the MOISTURE mode options. This mode is only available for pinless measurements (internal sensor).
2. When the SET REFERENCE mode is selected the displays are affected in the following ways:
  - IGM Moisture image mode: A new display line will appear preceded by a delta (triangle) symbol. The digits next to the delta symbol indicate the reference value (the measurement recorded when the SET REFERENCE mode is selected).
  - IGM Custom image mode: Only the delta icon is shown in the IGM Custom screen, not the reference value.
  - Moisture-only mode: The Reference value and delta symbol are shown on the right side of the display, refer to example screen in Fig. 5-1(c).
3. All measurements taken subsequently will be relative to the reference value. For example, if the reference value is '10' (representing the driest area of the material under test) and a measurement of '50' is taken (in an area with higher moisture content), the measurement line will show '40' ( $50 - 10 = 40$ ). As implied, this mode is useful for comparing wet areas to a dry area reference.
4. To remove the reference value and exit the mode: Remove the meter sensor from the area under test, so that the sensor is no longer touching a surface and is clear of any objects (keep hands away from the sensor also), and then press the Set Reference icon again. The reference value will no longer be visible on the meter display.

## 5.3 Thermal Imager (IR)

The full screen IR Thermal Imager is active in the IR -only mode  , the IGM Custom mode  , and the IGM Moisture mode  (selectable from the IMAGE mode icon  in the Main Menu).

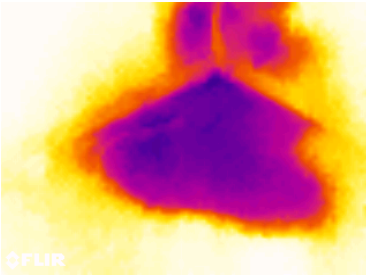
The Thermal Imager lens is located on the back of the meter. Face the lens toward the area of interest and view the image on the meter display.

Select the IR thermal image display color palette from the Settings menu. Select IRON, RAINBOW, ICE, or GRAYSCALE; see examples in Fig. 5-5.

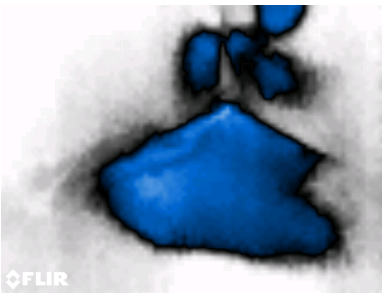
For example: the ICE palette hot to cold temperatures, for images, are represented by this color palette progression: white>grey>black>blue>white. See the color palette example below in figure 5-5(c). For the ICE palette, the right side of the scale shows the hotter pixels in the frame, and the left side of the scale shows the coldest pixels.

**Fig. 5-5 Thermal IR Image Color Palettes**

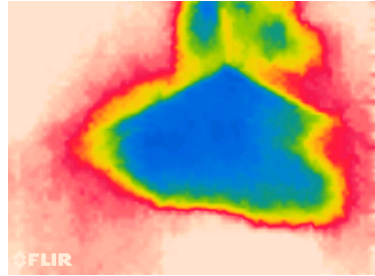
**Fig. 5-5(a) - IRON PALETTE**



**Fig. 5-5(c) - ICE PALETTE**



**Fig. 5-5(b) - RAINBOW PALETTE**



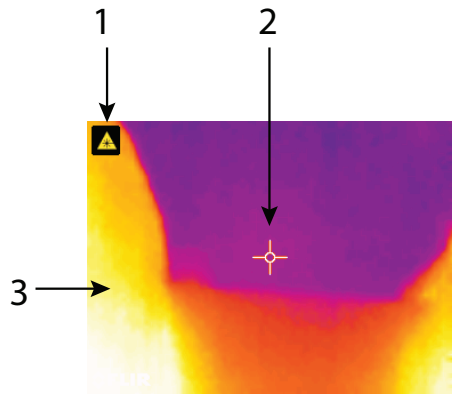
**Fig. 5-5(d) - GREY PALETTE**



When the Laser Pointer button is pressed, and held to activate the laser pointer, the display crosshairs also switch on, for additional targeting flexibility. Refer to Fig. 5-6.

Note that the laser is carefully aimed to align with the crosshairs for easier identifying and targeting of objects and surfaces.

1. Laser icon (Press and hold Laser button to activate)
2. Crosshairs (Press and hold Laser button to activate)
3. IR Thermal Image



**Fig. 5-6 Thermal IR Image**



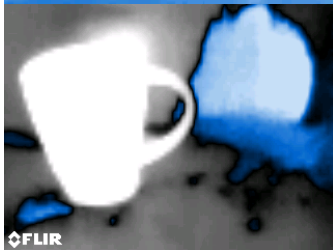
## 5.4 Lock/Unlock Palette Auto-Scale Mode

Note: For best results, allow a warm-up period of 3-5 minutes before using this feature.

The Lock/Unlock Palette Auto-Scale option allows the color palette range to be adjusted to suit a given application. For example, when viewing both cold and hot objects in the same frame, the palette auto-scaling will cause the palette to be 'stretched' to fit the whole range of temperatures. However, this can cause smaller temperature variations to disappear, as the difference between two colors might increase from 1° to 10°. In this case, the user may choose to lock the scale with only the cold or medium-temperature object in the frame. This would cause the hot object to saturate, but will provide more detail to the colder objects of interest.




**Fig. 5-7(a)** Palette auto-scale unlocked




**Fig. 5-7(b)** Palette auto-scale locked  
away from hot object

If the user wishes to narrow the range of color and limit it to colors near the cold temperature image, Lock/Unlock can be set to 'Lock' with no hot objects in the frame. To lock the scale, press the Select button to access the Main Menu, scroll to the Lock icon, and press Select again to toggle unlock/lock. Some experimentation and fine-tuning may be required to get the best possible contrast for the application.

## 5.5 Screen Capture and Hold

Pressing the **Image Capture** button  captures the current MR176 screen. The screen will hold (freeze) for seven (7) seconds, until an image file-name appears indicating that the image has been saved. During the seven second 'hold' period, the user can simply examine the image and press the Back button to discard or press Select/Capture to save the image.

Images are saved in bitmap (.bmp) format. Images can be accessed on the MR176 screen using the Image Review icon  available in the Main Menu. Then scroll the images using the Left and Right navigation buttons.

Images can be deleted one by one by pressing the Select button while viewing the image. A prompt will appear asking to 'Delete' or 'Cancel'. Choose 'Delete' to permanently discard the image; choose 'Cancel' to keep the image.

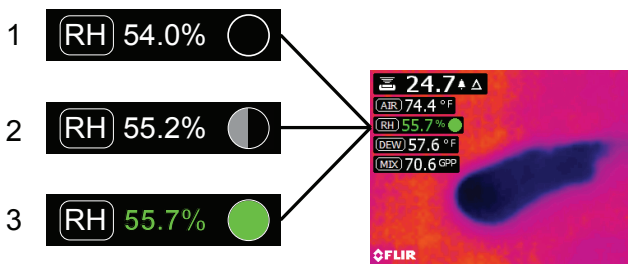
Images can also be transferred to computer or other compatible device using the MR176 USB port (bottom of meter, under flap) and supplied USB cable.

## 5.6 Progressive Environmental Stability Indicator

The Progressive Environmental Stability Indicator is useful for determining when relative humidity readings on the MR176 have stabilized. This feature is especially useful when a series of readings is taken in a variety of locations with diverse environmental conditions.

The circle next to the RH% display line (shown in Fig. 5-8) fills and turns green when the relative humidity reading stabilizes. For Fig. 5-8, line 1, the indicator is hollow indicating that the reading has not stabilized; line 2 indicates that the reading is stabilizing; line 3 indicates that the reading has fully stabilized (green circle with green relative humidity reading digits).

Note that for areas where environmental conditions change frequently, the indicator may not entirely fill and turn green, this is normal. The indicator is available in the IGM Custom, IGM Moisture, and Psychrometric modes.

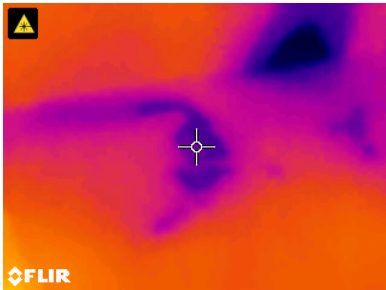


**Fig. 5-8** Progressive Environmental Stability Indicator

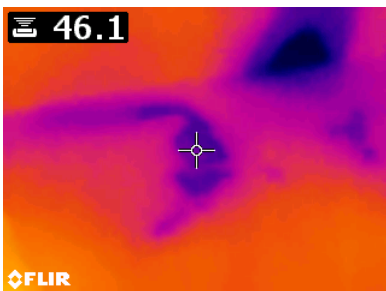
## 5.7 'Combination' Feature: Save Thermal Image with Pinless Moisture Reading

The Combination feature allows the user to 'freeze' a thermal image and take a moisture reading, saving both the thermal image and the moisture reading on a single image. The 'held' thermal image, with continuous moisture reading shown on the same screen, can then be captured as explained in Section 5.5 above.

1. Enter the IGM Moisture or IGM Custom Image mode (refer to Section 5.2.3 Image Mode).
2. Hold the Capture button until crosshairs appear and laser are visible (Fig. 5-9(a)).
3. While continuing to hold the Capture button, aim the laser at the measurement spot
4. Release the Capture button. The image will freeze but the moisture reading will flash and continue to update as it waits for a measurement.
5. Make the desired measurement and press the Select button to capture (save) the image; note that the image will include the moisture reading; see Fig. 5-9(b).
6. After a seven second hold period, an image file-name will appear on the screen (FLIRxxxx.bmp), indicating the image has been saved. During this time-out period, the user can press Back to cancel the image capture, or Select/Capture to save the image.




**Fig. 5-9(a)** Laser and Crosshairs visible;  
Aim the Laser at the test surface




**Fig. 5-9(b)** Saved image with Target  
area and Moisture reading


## 5.8 High Moisture Alarm

The MR176 offers a High Moisture Alarm where an audible and visual alert activates when the moisture reading exceeds the programmed high limit.

1. Press the Select button to access the Main Menu
2. Select the SETTINGS mode  from the Main Menu
3. Scroll to ALARM and press the Select button to open the Alarm programmer
4. Use the Navigation and Select buttons to switch the alarm ON or OFF and to set the threshold from 0% to 100%
5. Press the Select button to return to the SETTINGS mode and save the value or press the back button to cancel and to return to the normal operating mode
6. When the High Alarm is set ON, the main display will show the alarm bell icon (shown in header above) and the High Alarm threshold value (the only exception is the IGM Custom mode where only the Alarm icon is shown, not the Alarm threshold value). Refer to example screens shown in Fig. 5-1(b and c).
7. When the measurement exceeds the threshold, the text for the measurement reading will appear red in color and will flash. Note that in the Moisture-only mode, the bargraph turns red when the Alarm threshold is exceeded. Refer to the example in Fig. 5-1(c).
8. To switch the alarm OFF when the meter is alarming, press the Select button and then select SETTINGS from the Main Menu

## 5.9 SETTINGS Menu

Access the SETTINGS menu by pressing the Select button and choosing the Settings icon  . The Settings menu options are described below:

1. **LANGUAGE.** Choose the desired language for text displays. From the Settings menu, scroll to **Language** and press the Select button. The selected language will show a blue dot to its right. Use the four Navigation buttons to scroll to the desired language and then press the Select button to confirm. When the Select button is pressed to confirm, the meter will return to the Settings menu and will display the newly selected language. Press the back button  at any time to cancel the language selection and return to the Settings menu.

The 14 available languages are: English, Czech, German, Spanish, French, Italian, Japanese, Korean, Dutch, Polish, Portuguese, Russian, Chinese, and Finnish

2. **CONFIGURE IGM CUSTOM.** This mode allows the user to choose the value(s) that will be displayed in the IGM Custom Image mode. From the SETTINGS menu scroll to 'Configure IGM Custom' selection and press the Select button. Now use the navigation buttons to scroll and the Select button to check/uncheck measurement values. Moisture, Temperature, Relative Humidity, Dew Point, Mixing ratio, and Vapor Pressure can be toggled on and off. When done, use the Back button to save the selected readings and return to the Settings menu.

3. **PALETTE.** Select the desired color scheme for the IR Thermal images. From the Settings menu scroll to the Palette selection and use the Select button to step through the IRON, RAINBOW, ICE, and GREY selections. Refer to Fig. 5-5 for example palette screens. Navigate to another Settings option or press the back button to exit the Settings menu.
4. **ALARM.** Set a high alarm threshold. From the Settings menu, scroll to **Alarm** and press the Select button. Use the up/down navigation buttons to arm/disarm the alarm (ON/OFF). Use the left/right navigation buttons to select an alarm threshold digit; use the up/down navigation buttons to set the high alarm threshold. Refer to Section 5.8 for Alarm details. The Alarm can be used in pin or pinless mode of operation. Press the Select button to save the value and return to the SETTINGS menu or press the back button to cancel and return to the Settings menu.
5. **AUTO POWER OFF.** From the SETTINGS menu, scroll to **Auto Power OFF** and then use the Select button to step through the available options (1, 5, 20 minutes, or OFF). Navigate to another Settings option or press the back button to exit the Settings menu.

The next items are located on the 2<sup>nd</sup> page of the Settings menu; use the navigation buttons to scroll down:

6. **UNITS.** Select the Temperature or Mixing Ratio units of measure. Scroll to the UNITS selection in the Settings menu and use the Select button to toggle degrees C and degrees F or GPP and g/kg. When complete, navigate to another Settings option or press the back button to exit the Settings menu.
7. **DATE & TIME.** From the SETTINGS menu, scroll to **Date & Time** and press the Select button. Use the left/right navigation buttons to select YYYY, MM, DD, HH : MM (from left to right) and use the up/down navigation buttons to change the digits. Press the Select button to save the value and return to Settings menu or press the back button to cancel and return to the normal operating mode.
8. **HELP SCREEN.** Scroll to HELP and press the Select button to view the company contact information. Press the back button to return to the Settings menu.
9. **METER INFORMATION.** From the SETTINGS menu, scroll to **Meter Information** and press the Select button to view the Model, Software Version, and Last Calibration Date information. Press the back button to return to the Settings menu.

## **6. Maintenance**

---

### **6.1 Cleaning**

Clean the meter with a damp cloth and mild detergent; do not use abrasives or solvents.

### **6.2 Battery Charging**

1. The internal battery is not user serviceable.
2. Please charge the battery before first use.
3. Connect the meter to an AC source or a computer USB port using the supplied USB charger cable. The USB port is located on the bottom of the meter, under the protective flap, next to the EXT Probe jack.
4. While the meter is charging, a blue LED (bottom of meter under protective flap) indicates that charging is successfully taking place.
5. View the battery status icon on the upper left hand corner of the meter's display when a program menu is active.

#### **6.2.1 Disposal of Electronic Waste**

As with most electronic products, this equipment must be disposed of in an environmentally friendly way, and in accordance with existing regulations for electronic waste.

Please contact your local FLIR Systems representative for more details.

## 6.3 Updating the MR176 firmware

The MR176 firmware can be updated in the field by the user, without the need for sending the unit in for service. If assistance is required, the user can contact a FLIR technical specialist (see Section 8). Firmware updates provide performance enhancements and new features and functions.

To update the firmware the following is required:

- Access to the website where the update file(s) are located: <http://support.flir.com>
- The MR176 to be updated
- The update files

Follow the steps below:

1. Visit [support.flir.com](http://support.flir.com) to check for the latest updates.
2. Select the 'Downloads' tab and then select 'Instrument Firmware' (Test and Measurement) from the drop down menu.
3. Select MR176 from the second drop down menu.
4. Select and download the updated firmware.
5. Turn the meter on, and connect it to a computer via USB.
6. Copy the update file(s) into the root directory of the MR176 drive (e.g. MR176\_v1\_962.hex).
7. Disconnect the meter from the USB port.
8. Hold the power button for one second to turn the meter off.
9. Press the power button to turn the meter on again. The screen should remain dark; the unit will beep twice to signal that the update has started.
10. After ~10s it will beep again signaling that the update is complete.
11. Press the power button to turn the meter on; the new version should now be running.
12. If there is an error, repeat the procedure. If a problem persists, contact FLIR technical support.

## 7. Specifications

---

### General Specifications

Display	QVGA (320 x 240 pixel) 2.3" 64K color TFT graphical display
Internal memory	4GB; Storage capacity is 9999 images
Stored image format	Bitmap (.bmp) with measurement values overlaid
Power supply	3.7V, 3000mAh (2 x 1500mAh Li-ion) battery; rechargeable via USB
Battery life	18 hours continuous run-time, maximum
Auto Power OFF	Programmable: OFF, 1, 5, or 20 minutes
Low battery indicator	☐ is displayed in the Main Menu screen
Operating temperature	32~122 °F (0~50 °C)
Storage temperature	14~140°F (-10~60°C)
Operating humidity	≤ 90%, 32~86°F (0~30°C) ≤ 75%, 86~104°F (30~40°C) ≤ 45%, 104~122°F (40~50°C)
Storage humidity	90% RH
Dimensions (H x W x D)	6.9 x 2.9 x 1.7" (17.5 x 7.2 x 4.2 cm)
Product Weight	11.4 oz. (323g)
Drop test	3 meter drop test approval pending
Certification standards	EN61326 (EMC), EN60825-1 Class 2 (Laser)
Agency approvals	CE, FCC Class B
Included accessories	MR01 replaceable Temperature and RH Sensor, MR02 Standard Pin Probe, Quick Start Guide, International USB charger, and USB cable
Language options	Meter display text can be shown in any of fourteen (14) languages

### Imaging Specifications

Thermal imaging camera	FLIR Lepton® module, microbolometer FPA (focal plane array)
Image calibration	Automatic (with manual lock scale option)
Thermal image resolution	80(W) x 60(H) pixels (4800 pixels)
Spectral response	8~14μm
Field of view	51° horizontal x 38° vertical
Thermal Sensitivity	< 150mK
Detection Limit	Wet area detection @32' (10m): 19.7in <sup>2</sup> (49cm <sup>2</sup> )
Thermal frame update rate	9 Hz
Thermal image palettes	Selectable: Iron, Rainbow, Ice, Gray scale
Minimum focus distance	4" (10cm)
Laser pointer	Visible light Class II, centered on thermal image; 1.0mW (max. power) Wavelength: 650 ±20nm



## Moisture Meter Specifications

Internal Pinless Sensor Measurements	0 to 100 (relative readings)
External Pin-based Measurements	7% - 30%* ( $\pm 1.5\%$ MC*) 30%-100%* (Reference Only)
Measurement Resolution	0.1
Pinless Measurement Depth	0.75" (1.9cm) maximum
Pin Moisture Groups	Nine (9) material groups
Response time	Pinless mode: 100ms Pin mode: 750ms

### Notes:

\* Maximum specified range is dependent on the fiber saturation point for specific species. Beyond this point, the reading can only be used as a relative reference value. For more information on fiber saturation please refer to ASTM D7438. Accuracy specification is based on the analysis in J. Fernández-Golfín et al. Actual real-world accuracy depends on a variety of factors; For more information, refer to ASTM D4444, section 6.

\*\*Accuracy spec. applies to pin probe moisture measurements taken on wood whose temperature is 70°F (20°C). Add 0.1% to the accuracy spec. for each °C below 20 or subtract 0.1 for each °C above 20.

## Thermo-Hygrometer Environmental Specification Table

Parameter	Range	Accuracy	Resolution
Relative Humidity	10-90%	$\pm 2.5\%$	0.1
Air Temperature	32 to 122°F (0 to 50°C)	$\pm 0.6^\circ\text{C}$ ( $\pm 1.1^\circ\text{F}$ )	
Dew Point	-22 to 122°F (-30 to 50°C)	n/a (calculation)	
Vapor Pressure	0.0–12.0 kPa	n/a (calculation)	
Mixing Ratio	0.0-80.0 g/kg (0-560 GPP)	n/a (calculation)	

### Relative Humidity Sensor Note:

The meter should be stored in an environment with a relative humidity similar to the area to be tested. If the storage humidity differs by more than 50% RH from the area under test, an acclimation period of up to 24 hours may be required to meet the specified RH accuracy.

## 8. Technical Support

---

<b>Main Website</b>	<a href="http://www.flir.com/test">http://www.flir.com/test</a>
<b>Technical Support Website</b>	<a href="http://support.flir.com">http://support.flir.com</a>
<b>Technical support Email</b>	TMSupport@flir.com
<b>Service/Repair Support Email</b>	Repair@flir.com
<b>Support Telephone number</b>	+1 855-499-3662 option 3 (toll-free)
<b>Firmware Updates</b> To check for MR176 firmware updates please visit the technical support website (above) for complete installation instructions.	

## 9. Material Groups

### 9.1 Common Names of Timbers (BS888/589:1973) with MR176 Group Nos.

**Note: GROUP 9 is for Building materials: Plywood, drywall, OCD, etc.**

Abura	4	Gurjun	1	Pine, American Long Leaf	3
Afara	1	Hemlock, Western	3	Pine, American Pitch	3
Aformosa	6	Hiba	8	Pine, Bunya	2
Afzelia	4	Hickory	5	Pine, Caribbean Pitch	3
Agba	8	Hyedunani	2	Pine, Corsican	3
Amboyna	6	Iroko	5	Pine, Hoop	3
Ash, American	2	Ironbank	2	Pine, Huon	2
Ash, European	1	Jarrah	3	Pine, Japanese Black	2
Ash, Japanese	1	Jelutong	3	Pine, Kauri	4
Ayan	3	Kapur	1	Pine, Lodgepole	1
Baguacu, Brazilian	5	Karri	1	Pine, Maritime	2
Balsa	1	Kauri, New Zealand	4	Pine, New Zealand White	2
Banga Wanga	1	Kauri, Queensland	8	Pine, Nicaraguan Pitch	3
Basswood	6	Keruing	5	Pine, Parana	2
Beech, European	3	Kuroka	1	Pine, Ponderosa	3
Berlina	2	Larch, European	3	Pine, Radiata	3
Binvang	4	Larch, Japanese	3	Pine, Red	2
Birch, European	8	Larch, Western	5	Pine, Scots	1
Birch, Yellow	1	Lime	4	Pine, Sugar	3
Bisselon	4	Loliondo	3	Pine, Yellow	1
Bitterwood	5	Mahogany, African	8	Poplar, Black	1
Blackbutt	3	Mahogany, West Indian	2	Pterygota, African	1
Bosquiea	1	Makore	2	Pyinkado	4
Boxwood, Maracaibo	1	Mansonia	2	Queensland Kauri	8
Camphorwood, E African	3	Maple, Pacific	1	Queensland Walnut	3
Canarium, African	2	Maple, Queensland	2	Ramin	6
Cedar, Japanese	2	Maple, Rock	1	Redwood, Baltic (European)	1
Cedar, West Indian	8	Maple, Sugar	1	Redwood, Californian	2
Cedar, Western Red	3	Matai	4	Rosewood, Indian	1
Cherry, European	8	Meranti, Red (dark/light)	2	Rubberwood	7
Chestnut	3	Meranti, White	2	Santa Maria	7
Coachwood	6	Merbau	2	Sapele	3

Cordia, American Light	5	Missanda	3	Sen	1
Cypress, E African	1	Muhuhi	8	Seraya, Red	3
Cypress, Japanese (18-28%mc)	3	Muninga	6	Silky Oak, African	3
Cypress, Japanese (8-18%mc)	8	Musine	8	Silky Oak, Australian	3
Dahoma	1	Musizi	8	Spruce, Japanese (18-28%mc)	3
Danta	3	Myrtle, Tasmanian	1	Spruce, Japanese (8-18%mc)	8
Douglas Fir	2	Naingon	3	Spruce, Norway (European)	3
Elm, English	4	Oak, American Red	1	Spruce, Sitka	3
Elm, Japanese Grey Bark	2	Oak, American White	1	Sterculia, Brown	1
Elm, Rock	4	Oak, European	1	Stringybark, Messmate	3
Elm, White	4	Oak, Japanese	1	Stringybark, Yellow	3
Empress Tree	8	Oak, Tasmanian	3	Sycamore	5
Erimado	5	Oak, Turkey	4	Tallowwood	1
Fir, Douglas	2	Obeche	6	Teak	5
Fir, Grand	1	Odoko	4	Totara	4
Fir, Noble	8	Okwen	2	Turpentine	3
Gegu, Nohor	7	Olive, E African	2	Utile	8
Greenheart	3	Olivillo	6	Walnut, African	8
Guarea, Black	8	Opepe	7	Walnut, American	1
Guarea, White	7	Padang	1	Walnut, European	3
Gum, American Red	1	Padauk, African	5	Walnut, New Guinea	2
Gum, Saligna	2	Panga Panga	1	Walnut, Queensland	3
Gum, Southern	2	Persimmon	6	Wandoo	8
Gum, Spotted	1	Pillarwood	5	Wawa	6
				Whitewood	3
				Yew	3

## 9.2 Botanical names of timbers with MR176 program group numbers

<i>Abies alba</i>	1	<i>Eucalyptus acmenicides</i>	3	<i>Picea jezoensis</i> (8-18%mc)	8
<i>Abies grandis</i>	1	<i>Eucalyptus crebra</i>	2	<i>Picea sitchensis</i>	3
<i>Abies procera</i>	8	<i>Eucalyptus diversicolor</i>	1	<i>Pinus caribaea</i>	3
<i>Acanthopanax ricinifolius</i>	1	<i>Eucalyptus globulus</i>	2	<i>Pinus contorta</i>	1
<i>Acer macrophyllum</i>	1	<i>Eucalyptus maculate</i>	1	<i>Pinus lampertiana</i>	3
<i>Acer pseudoplatanus</i>	5	<i>Eucalyptus marginata</i>	3	<i>Pinus nigra</i>	3
<i>Acer saccharum</i>	1	<i>Eucalyptus microcorys</i>	1	<i>Pinus palustris</i>	3
<i>Aetoxicon punctatum</i>	6	<i>Eucalyptus obliqua</i>	3	<i>Pinus pinaster</i>	2
<i>Aformosia elata</i>	6	<i>Eucalyptus pilularis</i>	3	<i>Pinus ponderosa</i>	3
<i>Azelia spp</i>	4	<i>Eucalyptus saligna</i>	2	<i>Pinus radiata</i>	3
<i>Agathis australis</i>	4	<i>Eucalyptus wandoo</i>	8	<i>Pinus spp</i>	2
<i>Agathis palmerstoni</i>	8	<i>Fagus sylvatica</i>	3	<i>Pinus strobus</i>	1
<i>Agathis robusta</i>	8	<i>Flindersia brayleyana</i>	2	<i>Pinus sylvestris</i>	1
<i>Amblygonocarpus andogensis</i>	1	<i>Fraxinus Americana</i>	2	<i>Pinus thunbergii</i>	2
<i>Amblygonocarpus obtusungulis</i>	1	<i>Fraxinus excelsior</i>	1	<i>Pipadeniastrum africanum</i>	1
<i>Araucaria angustifolia</i>	2	<i>Fraxinus japonicus</i>	1	<i>Piptadenia africana</i>	1
<i>Araucaria bidwilli</i>	2	<i>Fraxinus mardshurica</i>	1	<i>Podocarpus dacrydiodes</i>	2
<i>Araucaria cunninghamii</i>	3	<i>Gonystylus macrophyllum</i>	6	<i>Podocarpus spicatus</i>	3
<i>Berlinia grandiflora</i>	2	<i>Gossweilodendron balsamiferum</i>	8	<i>Podocarpus totara</i>	4
<i>Berlinia spp</i>	2	<i>Gossypiospermum proerox</i>	1	<i>Populus spp</i>	1
<i>Betula alba</i>	8	<i>Grevillea robusta</i>	3	<i>Prunus avium</i>	8
<i>Betula alleghaniensis</i>	8	<i>Guarea cedrata</i>	7	<i>Pseudotsuga menzesii</i>	2
<i>Betula pendula</i>	8	<i>Guarea thomsonii</i>	8	<i>Pterocarpus angolensis</i>	6
<i>Betula spp</i>	8	<i>Guibortia ehie</i>	2	<i>Pterocarpus indicus</i>	6
<i>Bosquiera phoberos</i>	1	<i>Hevea brasiliensis</i>	7	<i>Pterocarpus soyauxii</i>	5
<i>Brachylaena hutchinsii</i>	8	<i>Intsia bijuga</i>	2	<i>Pterygota bequaertii</i>	1
<i>Brachystegia spp</i>	2	<i>Juglans nigra</i>	1	<i>Quercus cerris</i>	4
<i>Calophyllum brasiliense</i>	7	<i>Juglans regia</i>	3	<i>Quercus delegatensis</i>	3
<i>Canarium schweinfurthii</i>	2	<i>Khaya ivorensis</i>	8	<i>Quercus gigantean</i>	3
<i>Cardwellia sublimes</i>	3	<i>Khaya senegalensis</i>	4	<i>Quercus robur</i>	1
<i>Carya glabra</i>	5	<i>Larix decidua</i>	3	<i>Quercus spp</i>	1
<i>Cassipourea elliotii</i>	5	<i>Larix kaempferi</i>	3	<i>Ricinodendron heudelotti</i>	5
<i>Cassipourea melanosana</i>	5	<i>Larix leptolepis</i>	3	<i>Sarcocephalus diderrichii</i>	7

Castanea sutiva	3	Larix occidentalis	5	Scottellia coriacea	4
Cedrela odorata	8	Liquidambar styraciflua	1	Sequoia sempervirens	2
Ceratopetalum apetala	6	Lovoa klaineana	8	Shorea spp	2
Chamaecyparis spp (18-28%mc)	3	Lovoa trichiloides	8	Sterculia rhinopetala	1
Chamaecyparis spp (8-18%mc)	8	Maesopsis eminii	8	Swietenia candollei	1
Chlorophora excelsa	5	Mansonia altissima	2	Swietenia mahogani	2
Cordia alliodora	5	Millettia stuhimannii	1	Syncarpia glomulifera	3
Croton megalocarpus	8	Mimusops heckelii	2	Syncarpia laurifolia	3
Cryptomelia japonica	2	Mitragyna ciliata	4	Tarrietia utilis	3
Cupressus spp	1	Nauclea diderrichii	7	Taxus baccata	3
Dacrydium franklinii	2	Nesogordonia papaverifera	3	Tectona grandis	5
Dalbergia latifolia	1	Nothofagus cunninghamii	1	Terminalia superba	1
Diospyros virginiana	6	Ochroma pyramidalis	1	Thuja plicata	3
Dipterocarpus (Keruing)	5	Ocotea rodiaei	3	Thujopsis dolabrata	8
Dipterocarpus zeylanicus	1	Ocotea usambarensis	3	Tieghamella heckelii	2
Distemonanthus benthamianus	3	Octomeles sumatrana	4	Tilia americana	6
Dracontomelum mangiferum	2	Olea hochstetteri	2	Tilia vulgaris	4
Dryobalanops spp	1	Olea welwitschii	3	Triploeliton scleroxyton	6
Dyera costulata	3	Palaquium spp	1	Tsuga heterophylla	3
Endiandra palmerstoni	3	Paulownia tomentosa	8	Ulmus americana	4
Entandrophragma angolense	7	Pericopsis elata	6	Ulmus procera	4
Entandrophragma cylindricum	3	Picaenia excelsa	3	Ulmus thomasii	4
Entandrophragma utile	8	Picea abies	3	Xylia dolabriformis	4
Erythrophleum spp	3	Picea jezoensis (18-28%mc)	3	Zelkova serrata	2

### 9.3 %WME Table (% Wood Moisture Equivalent)

Material Wood Group Nos.								
1	2	3	4	5	6	7	8	9
%WME (percent wood moisture equivalent)								
7	8.2	9	8	7.1	7	11	10.5	-
8	10	10.5	9.3	7.5	7.4	11.5	11	-
9	10.8	10.9	9.7	7.9	8.1	12.1	11.6	8.5
10	11.7	11.5	10.4	8.6	8.8	12.7	12.2	9.4
11	12.7	12.6	11.3	9.5	9.7	13.4	13.4	10.5
12	13.6	13.7	12.1	10.5	10.5	14	14.3	11.5
13	14.5	14.5	12.7	11.2	11.2	14.5	15.1	12.5
14	15.3	15.5	13.4	11.8	11.8	15	16	13.5
15	16.3	16.7	14.1	12.5	12.6	15.6	17	14.4
16	16.9	17.5	14.8	13	13.2	16	17.7	14.9
17	17.7	18.8	15.7	14.3	13.9	16.6	18.5	15.3
18	18.2	19.7	16.3	15	14.5	17	19.1	16.1
19	19	21	16.9	15.9	15.2	17.6	20	16.7
20	20	22.6	17.8	16.9	16.1	18.4	21.3	17.2
21	20.8	23.5	18.5	17.6	16.8	19.1	22.3	18.3
22	21.5	24.5	19.3	18.3	17.4	19.7	23.2	19.1
23	22.9	26.4	20.2	19.8	18.6	21.2	25.3	19.9
24	23.5	27.4	20.8	20.4	19	22	25.8	20.5
25	24.2	27.8	21.2	21	19.4	22.7	26.3	≈23
26	25.3	29	22.4	22.3	20.1	23.9	27.3	-
27	26.5	-	23.3	23.4	20.8	24.7	28.1	-
28	28	-	24.4	24.8	21.7	25.9	-	-
29	29.6	-	25.6	26.3	22.9	27.1	-	-

## 10. Warranty

---

### 10.1 FLIR Test & Measurement 2 year/10 year Limited Warranty

Congratulations! You (the “Purchaser”) are now the owner of a world-class FLIR Imaging Test and Measurement product. A qualifying FLIR Imaging Test and Measurement product (the “Product”) purchased either directly from FLIR Commercial Systems Inc. and affiliates (FLIR) or from an authorized FLIR distributor that Purchaser registers on-line with FLIR is eligible for coverage under FLIR’s industry-leading 2-10 Limited Warranty, subject to the terms and conditions in this document. This warranty only applies to purchases of Qualifying Products (see below) purchased after July 2014 and only to the original Purchaser of the Product.

PLEASE READ THIS DOCUMENT CAREFULLY; IT CONTAINS IMPORTANT INFORMATION ABOUT THE PRODUCTS THAT QUALIFY FOR COVERAGE UNDER THE 2-10 LIMITED WARRANTY, PURCHASER’S OBLIGATIONS, HOW TO ACTIVATE THE WARRANTY, WARRANTY COVERAGE, AND OTHER IMPORTANT TERMS, CONDITIONS, EXCLUSIONS AND DISCLAIMERS.

**1. PRODUCT REGISTRATION.** To qualify for FLIR’s 2-10 Limited Warranty, the Purchaser must fully register the Product directly with FLIR on-line at [www.flir.com](http://www.flir.com) WITHIN Sixty (60) DAYS of the date the Product was purchased by the first retail customer (the “Purchase Date”). PRODUCTS THAT ARE NOT REGISTERED ON-LINE WITHIN Sixty (60) DAYS OF THE PURCHASE DATE OR PRODUCTS WHICH DO NOT QUALIFY FOR THE 2-10 WARRANTY WILL HAVE A LIMITED ONE YEAR WARRANTY FROM THE DATE OF PURCHASE.

**2. QUALIFYING PRODUCTS.** Upon registration, a list of thermal Imaging Test and Measurement Products that qualify for coverage under FLIR’s 2-10 Warranty can be found at [www.flir.com/testwarranty](http://www.flir.com/testwarranty)

**3. WARRANTY PERIODS.** The 2-10 Limited Warranty has two separate periods of warranty coverage (the “Warranty Period”), depending on the Imaging Test and Measurement Product part:

Product components (excluding thermal imaging sensor) are warranted for a period of two (2) years from the Purchase Date;

Thermal imaging sensor is warranted for a period of ten (10) years from the Purchase Date.

Any Product that is repaired or replaced under warranty is covered under this 2-10 Limited Warranty for one hundred eighty days (180) days from the date of return shipment by FLIR or for the remaining duration of the applicable Warranty Period, whichever is longer.

**4. LIMITED WARRANTY.** In accordance with the terms and conditions of this 2-10 Limited Warranty, and except as excluded or disclaimed in this document, FLIR warrants, from the Purchase Date, that all fully registered Products will conform to FLIR’s published Product specifications and be free from defects in materials and workmanship during the applicable Warranty Period. PURCHASER’S SOLE AND EXCLUSIVE REMEDY UNDER THIS WARRANTY, AT FLIR’S SOLE DISCRETION, IS THE REPAIR OR REPLACEMENT OF DEFECTIVE PRODUCTS IN A MANNER, AND BY A SERVICE CENTER, AUTHORIZED BY FLIR. IF THIS REMEDY IS ADJUDICATED TO BE INSUFFICIENT, FLIR SHALL REFUND PURCHASER’S PAID PURCHASE PRICE AND HAVE NO OTHER OBLIGATION OR LIABILITY TO BUYER WHATSOEVER.

**5. WARRANTY EXCLUSIONS AND DISCLAIMERS.** FLIR MAKES NO OTHER WARRANTY OF ANY KIND WITH RESPECT TO THE PRODUCTS. ALL OTHER WARRANTIES, EXPRESS OR IMPLIED, INCLUDING BUT NOT LIMITED TO IMPLIED WARRANTIES OF MERCHANTABILITY, FITNESS FOR A PARTICULAR PURPOSE (EVEN IF PURCHASER HAS NOTIFIED FLIR OF ITS INTENDED USE FOR THE PRODUCTS), AND NON-INFRINGEMENT ARE EXPRESSLY EXCLUDED FROM THIS AGREEMENT.

THIS WARRANTY EXPRESSLY EXCLUDES ROUTINE PRODUCT MAINTENANCE, AND SOFTWARE UPDATES. FLIR FURTHER EXPRESSLY DISCLAIMS ANY WARRANTY COVERAGE WHERE THE ALLEGED NONCONFORMITY IS DUE TO NORMAL WEAR AND TEAR OTHER THAN SENSORS, ALTERATION, MODIFICATION, REPAIR, ATTEMPTED REPAIR, IMPROPER USE, IMPROPER MAINTENANCE, NEGLIGENCE, ABUSE, IMPROPER STORAGE, FAILURE TO FOLLOW ANY PRODUCT INSTRUCTIONS, DAMAGE (WHETHER CAUSED BY ACCIDENT OR OTHERWISE), OR ANY OTHER IMPROPER CARE OR HANDLING OF THE PRODUCTS CAUSED BY ANYONE OTHER THAN FLIR OR FLIR’S EXPRESSLY AUTHORIZED DESIGNEE.

THIS DOCUMENT CONTAINS THE ENTIRE WARRANTY AGREEMENT BETWEEN PURCHASER AND FLIR AND SUPERSEDES ALL PRIOR WARRANTY NEGOTIATIONS, AGREEMENTS, PROMISES AND UNDERSTANDINGS BETWEEN PURCHASER AND FLIR. THIS WARRANTY MAY NOT BE ALTERED WITHOUT THE EXPRESS WRITTEN CONSENT OF FLIR.



**6. WARRANTY RETURN, REPAIR AND REPLACEMENT.** To be eligible for warranty repair or replacement, Purchaser must notify FLIR within thirty (30) days of discovering of any apparent defect in materials or workmanship. Before Purchaser may return a Product for warranty service or repair, Purchaser must first obtain a returned material authorization (RMA) number from FLIR. To obtain the RMA number Owner must provide an original proof of purchase. For additional information, to notify FLIR of an apparent defect in materials or workmanship, or to request an RMA number, visit [www.flir.com](http://www.flir.com). Purchaser is solely responsible for complying with all RMA instructions provided by FLIR including but not limited to adequately packaging the Product for shipment to FLIR and for all packaging and shipping costs. FLIR will pay for returning to Purchaser any Product that FLIR repairs or replaces under warranty.

FLIR reserves the right to determine, in its sole discretion, whether a returned Product is covered under warranty. If FLIR determines that any returned Product is not covered under warranty or is otherwise excluded from warranty coverage, FLIR may charge Purchaser a reasonable handling fee and return the Product to Purchaser, at Purchaser's expense, or offer Purchaser the option of handling the Product as a non-warranty return. FLIR shall not be responsible for any data, images or other information that may be stored on the returned Product which was not included in the Product at the time of purchase. It is Purchaser's responsibility to save any and all data prior to returning the Product for warranty service.

**7. NON-WARRANTY RETURN.** Purchase may request that FLIR evaluate and service or repair a Product not covered under warranty, which FLIR may agree to do in its sole discretion. Before Purchaser returns a Product for non-warranty evaluation and repair, Purchaser must contact FLIR by visiting [www.flir.com](http://www.flir.com) to request an evaluation and obtain an RMA. Purchaser is solely responsible for complying with all RMA instructions provided by FLIR including but not limited to adequately packaging the Product for shipment to FLIR and for all packaging and shipping costs. Upon receipt of an authorized non-warranty return, FLIR will evaluate the Product and contact Purchaser regarding the feasibility of and the costs and fees associated with Purchaser's request. Purchaser shall be responsible for the reasonable cost of FLIR's evaluation, for the cost of any repairs or services authorized by Purchaser, and for the cost of repackaging and returning the Product to Purchaser. Any non-warranty repair of a Product is warranted for one hundred eighty days (180) days from the date of return shipment by FLIR to be free from defects in materials and workmanship only, subject to all of the limitations, exclusions and disclaimers in this document.



---

## Corporate Headquarters

FLIR Systems, Inc.  
2770 SW Parkway Avenue  
Wilsonville, OR 97070  
USA  
Telephone: +1 503-498-3547

## Customer Support

Technical Support Website	<a href="http://support.flir.com">http://support.flir.com</a>
Technical Support Email	<a href="mailto:TMSupport@flir.com">TMSupport@flir.com</a>
Service and Repair Email	<a href="mailto:Repair@flir.com">Repair@flir.com</a>
Customer Support Telephone	+1 855-499-3662 option 3 (toll free)

## Firmware Updates

To check for MR176 firmware updates please visit the technical support website (above) for complete installation instructions.

Publication Identification No.:	MR176-en-US
Release Version:	AA
Release Date:	2015 September
Language:	en-US