

FUNCTION GENERATOR KIT

MODEL FG-500K



7 56619 00162 3



Assembly and Instruction Manual

ELENCO®

PARTS LIST

If you are a student, and any parts are missing or damaged, please see instructor or bookstore.

If you purchased this kit from a distributor, catalog, etc., please contact ELENCO® (address/phone/e-mail is at the back of this manual) for additional assistance, if needed. **DO NOT** contact your place of purchase as they will not be able to help you.

| RESISTORS | | | | |
|----------------------------|--------|---------------------|-------------------------|--------|
| Qty. | Symbol | Description | Color Code | Part # |
| <input type="checkbox"/> 1 | R6 | 200Ω 5% ¼W | red-black-brown-gold | 132000 |
| <input type="checkbox"/> 1 | R1 | 620Ω 5% ¼W | blue-red-brown-gold | 136200 |
| <input type="checkbox"/> 1 | R5 | 3.9kΩ 5% ¼W | orange-white-red-gold | 143900 |
| <input type="checkbox"/> 1 | R7 | 8.2kΩ 5% ¼W | gray-red-red-gold | 148200 |
| <input type="checkbox"/> 1 | R8 | 10kΩ 5% ¼W | brown-black-orange-gold | 151000 |
| <input type="checkbox"/> 1 | R4 | 22kΩ 5% ¼W | red-red-orange-gold | 152200 |
| <input type="checkbox"/> 1 | R9 | 100kΩ 5% ¼W | brown-black-yellow-gold | 161000 |
| <input type="checkbox"/> 1 | R2 | 10kΩ Potentiometer | | 192531 |
| <input type="checkbox"/> 1 | R3 | 100kΩ Potentiometer | | 192612 |







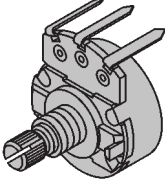
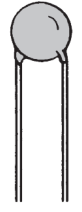
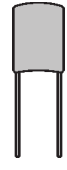
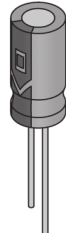
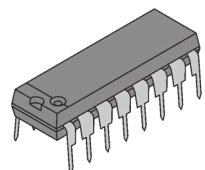
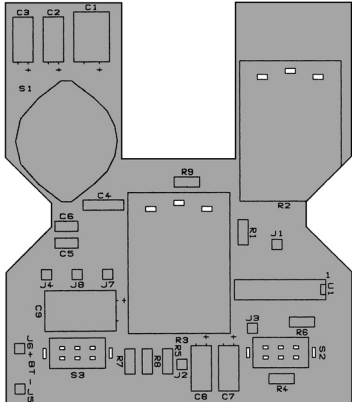
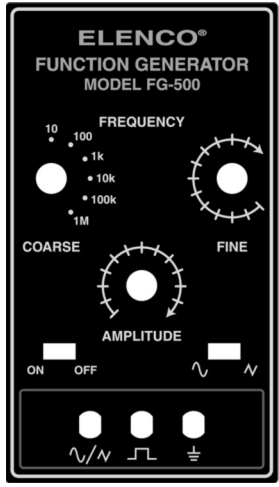
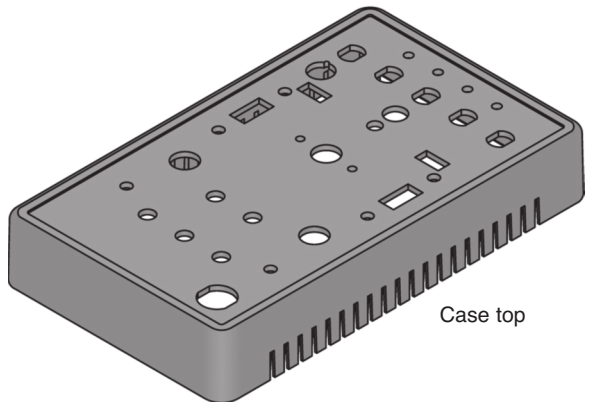
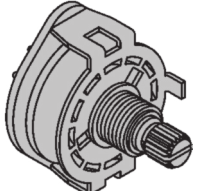

| CAPACITORS | | | | |
|----------------------------|------------|-----------------|----------------------|--------|
| Qty. | Symbol | Value | Description | Part # |
| <input type="checkbox"/> 1 | C6 | 820pF (821) 10% | Discap | 228210 |
| <input type="checkbox"/> 1 | C5 | .01μF (103) 10% | Mylar | 240119 |
| <input type="checkbox"/> 1 | C4 | .1μF (104) 10% | Mylar | 251017 |
| <input type="checkbox"/> 1 | C3 | 1μF 50V | Electrolytic (Lytic) | 261047 |
| <input type="checkbox"/> 3 | C2, C7, C8 | 10μF 16V | Electrolytic (Lytic) | 271045 |
| <input type="checkbox"/> 1 | C1 | 100μF 16V | Electrolytic (Lytic) | 281044 |
| <input type="checkbox"/> 1 | C9 | 1,000μF 16V | Electrolytic (Lytic) | 291044 |

| SEMICONDUCTORS | | | | |
|----------------------------|--------|---------|-------------------------|--------|
| Qty. | Symbol | Value | Description | Part # |
| <input type="checkbox"/> 1 | U1 | XR-2206 | Integrated circuit (IC) | 332206 |

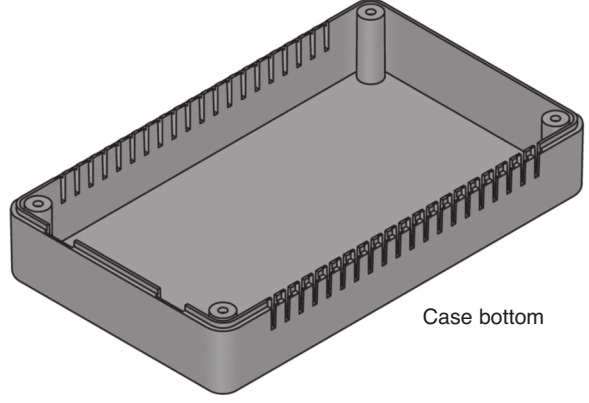
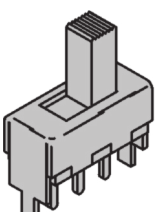
| MISCELLANEOUS | | | | | |
|----------------------------|-------------------------|----------|-----------------------------|-------------------------|--------|
| Qty. | Description | Part # | Qty. | Description | Part # |
| <input type="checkbox"/> 1 | PC board | 511003 | <input type="checkbox"/> 4 | Screw 2.8 x 8mm | 641102 |
| <input type="checkbox"/> 2 | DPDT switch PC mount | 541009 | <input type="checkbox"/> 3 | Hex nut 7mm | 644101 |
| <input type="checkbox"/> 1 | Switch rotary 2p6pos | 542207 | <input type="checkbox"/> 1 | Hex switch nut 9 x 15mm | 644102 |
| <input type="checkbox"/> 1 | Battery snap | 590098 | <input type="checkbox"/> 2 | Flat washer 8 x 14mm | 645101 |
| <input type="checkbox"/> 1 | Battery holder | 590099 | <input type="checkbox"/> 1 | Flat washer 9mm | 645103 |
| <input type="checkbox"/> 3 | Knob | 622009 | <input type="checkbox"/> 4 | Rubber foot | 662015 |
| <input type="checkbox"/> 1 | Case top | 623061 | <input type="checkbox"/> 1 | 16-pin IC socket | 664016 |
| <input type="checkbox"/> 1 | Case bottom | 623062 | <input type="checkbox"/> 1 | Label top panel | 721008 |
| <input type="checkbox"/> 1 | Binding post black | 625031 | <input type="checkbox"/> 1" | Double-sided tape | 740020 |
| <input type="checkbox"/> 3 | Nut binding post | 625031HN | <input type="checkbox"/> 9" | Black wire 22ga. | 814120 |
| <input type="checkbox"/> 3 | Lockwasher binding post | 625031LW | <input type="checkbox"/> 1 | Lead-free solder | 9LF99 |
| <input type="checkbox"/> 2 | Binding post yellow | 625034 | | | |

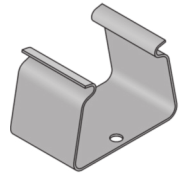
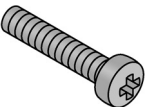
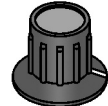
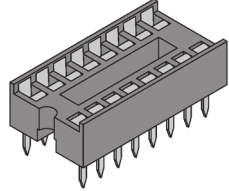
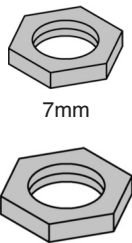
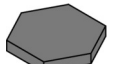
PARTS VERIFICATION

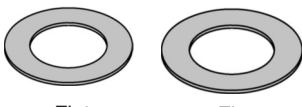
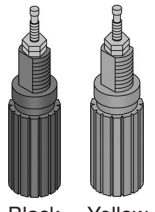
Before beginning the assembly process, familiarize yourself with the components and this instruction book. Verify that all of the parts are present. This is best done by checking off the parts in the parts list.

| RESISTORS | CAPACITORS | SEMICONDUCTOR |
|---|---|---|
|  <p>Carbon film</p>  <p>Potentiometer</p> |  <p>Discap</p>  <p>Mylar</p>  <p>Electrolytic (radial)</p> |  <p>XR-2206 Integrated circuit (IC)</p> |
| MISCELLANEOUS | | |
|  <p>PC board</p> |  <p>Label</p> |  <p>Case top</p> |
|  <p>Rotary switch</p> |  <p>Lead-free solder</p> |  <p>Case bottom</p> |
|  <p>DPDT switch</p> |  <p>Battery snap</p> |  <p>Battery holder</p> |
|  <p>Screws 2.8 x 8mm</p> |  <p>Knob</p> |  <p>16-pin IC socket</p> |
|  <p>Nuts 7mm 9mm</p> |  <p>Rubber foot</p> |  <p>Double-sided tape</p> |
|  <p>Washers Flat 8 x 14mm Flat 9 x 15mm</p> |  <p>Binding posts Black Yellow</p> |  <p>Binding post nut Binding post lockwasher</p> |
| | |  <p>Black wire 22ga.</p> |

IDENTIFYING RESISTOR VALUES

Use the following information as a guide in properly identifying the value of resistors.

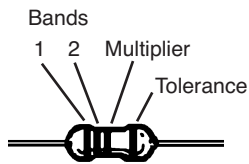

| BAND 1 1st Digit | |
|---------------------|-------|
| Color | Digit |
| Black | 0 |
| Brown | 1 |
| Red | 2 |
| Orange | 3 |
| Yellow | 4 |
| Green | 5 |
| Blue | 6 |
| Violet | 7 |
| Gray | 8 |
| White | 9 |

| BAND 2 2nd Digit | |
|---------------------|-------|
| Color | Digit |
| Black | 0 |
| Brown | 1 |
| Red | 2 |
| Orange | 3 |
| Yellow | 4 |
| Green | 5 |
| Blue | 6 |
| Violet | 7 |
| Gray | 8 |
| White | 9 |

| Multiplier | |
|------------|------------|
| Color | Multiplier |
| Black | 1 |
| Brown | 10 |
| Red | 100 |
| Orange | 1,000 |
| Yellow | 10,000 |
| Green | 100,000 |
| Blue | 1,000,000 |
| Silver | 0.01 |
| Gold | 0.1 |

| Resistance Tolerance | |
|----------------------|-----------|
| Color | Tolerance |
| Silver | ±10% |
| Gold | ±5% |
| Brown | ±1% |
| Red | ±2% |
| Orange | ±3% |
| Green | ±.5% |
| Blue | ±.25% |
| Violet | ±.1% |

IDENTIFYING CAPACITOR VALUES

Capacitors will be identified by their capacitance value in pF (picofarads), nF (nanofarads) or μ F (microfarads). Most capacitors will have their actual value printed on them. Some capacitors may have their value printed in the following manner.

Electrolytic capacitors have a positive and a negative electrode. The negative lead is indicated on the packaging by a stripe with minus signs and possibly arrowheads. Also, the negative lead of a radial electrolytic is shorter than the positive one.

| Multiplier | For the No. | 0 | 1 | 2 | 3 | 4 | 5 | 8 | 9 |
|------------|-------------|---|----|-----|----|-----|------|-----|-----|
| | Multiply By | 1 | 10 | 100 | 1k | 10k | 100k | .01 | 0.1 |

Warning:

If the capacitor is connected with incorrect polarity, it may heat up and either leak, or cause the capacitor to explode.

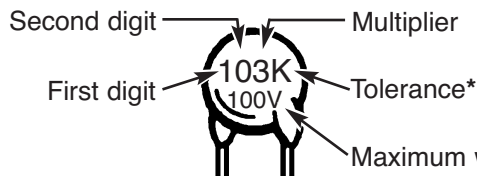
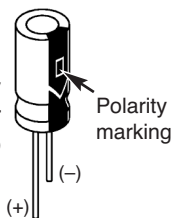

Note: The letter "R" may be used at times to signify a decimal point; as in 3R3 = 3.3

The value is $10 \times 1,000 = 10,000\text{pF}$ or $.01\mu\text{F}$ 100V

* The letter M indicates a tolerance of $\pm 20\%$
The letter K indicates a tolerance of $\pm 10\%$
The letter J indicates a tolerance of $\pm 5\%$

INTRODUCTION

Assembly of your FG-500 Function Generator will prove to be an exciting project and give much satisfaction and personal achievement. The FG-500 contains a complete function generator capable of producing sine, square and triangle wave forms. The frequency of this generator can be continuously varied from 1Hz to 1MHz in 6 steps. A fine frequency control

makes selection of any frequency in between easy. The amplitude of the wave forms are adjustable from 0 to 3Vpp. This complete function generator system is suitable for experimentation and applications by the student. The entire function generator is comprised of a single XR-2206 monolithic IC and a limited number of passive circuit components.

SPECIFICATIONS

OUTPUT:

- Waveforms: Sine, Triangle, Square
- Impedance: $600\Omega \pm 10\%$.
- Frequency: 1Hz - 1MHz in 6 decade steps with variable ranges.

SINE WAVE:

- Amplitude: 0 - 3Vpp
- Distortion: Less than 1% (at 1kHz)
- Flatness: $\pm 0.05\text{dB}$ 1Hz - 100kHz

SQUARE WAVE:

- Amplitude: 8V (no load)
- Rise time: Less than 50ns (at 1kHz)
- Fall time: Less than 30ns (at 1kHz)
- Symmetry: Less than 5% (at 1kHz)

TRIANGLE WAVE:

- Amplitude: 0 - 3Vpp
- Linearity: Less than 1% (up to 100kHz)

POWER REQUIREMENTS:

- Standard 9V battery

OPERATING TEMPERATURE:

- 0°C to 50°C

CONSTRUCTION

Introduction

The most important factor in assembling your FG-500K Function Generator Kit is good soldering techniques. Using the proper soldering iron is of prime importance. A small pencil type soldering iron of 25 watts is recommended. **The tip of the iron must be kept clean at all times and well-tinned.**

Solder

For many years leaded solder was the most common type of solder used by the electronics industry, but it is now being replaced by lead-free solder for health reasons. This kit contains lead-free solder, which contains 99.3% tin, 0.7% copper, and has a rosin-flux core.

Lead-free solder is different from lead solder: It has a higher melting point than lead solder, so you need higher temperature for the solder to flow properly. Recommended tip temperature is approximately 700°F; higher temperatures improve solder flow but accelerate tip decay. An increase in soldering time may be required to achieve good results. Soldering iron tips wear out faster since lead-free solders are more corrosive and the higher soldering temperatures accelerate corrosion, so proper tip care is important. The solder joint finish will look slightly duller with lead-free solders.

Use these procedures to increase the life of your soldering iron tip when using lead-free solder:

- Keep the iron tinned at all times.
- Use the correct tip size for best heat transfer. The conical tip is the most commonly used.

- Turn off iron when not in use or reduce temperature setting when using a soldering station.
- Tips should be cleaned frequently to remove oxidation before it becomes impossible to remove. Use Dry Tip Cleaner (Elenco® #SH-1025) or Tip Cleaner (Elenco® #TTC1). If you use a sponge to clean your tip, then use distilled water (tap water has impurities that accelerate corrosion).

Safety Procedures

- **Always wear safety glasses or safety goggles to protect your eyes when working with tools or soldering iron, and during all phases of testing.** 
- Be sure there is **adequate ventilation** when soldering.
- Locate soldering iron in an area where you do not have to go around it or reach over it. Keep it in a safe area away from the reach of children.
- **Do not hold solder in your mouth.** Solder is a toxic substance. Wash hands thoroughly after handling solder.

Assemble Components

In all of the following assembly steps, the components must be installed on the top side of the PC board unless otherwise indicated. The top legend shows where each component goes. The leads pass through the corresponding holes in the board and are soldered on the foil side.

Use only rosin core solder.

DO NOT USE ACID CORE SOLDER!

What Good Soldering Looks Like

A good solder connection should be bright, shiny, smooth, and uniformly flowed over all surfaces.

1. Solder all components from the copper foil side only. Push the soldering iron tip against both the lead and the circuit board foil.

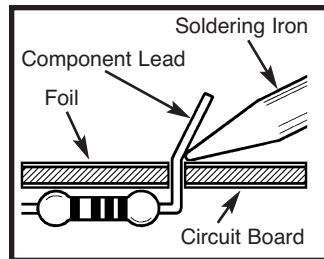

2. Apply a small amount of solder to the iron tip. This allows the heat to leave the iron and onto the foil. Immediately apply solder to the opposite side of the connection, away from the iron. Allow the heated component and the circuit foil to melt the solder.

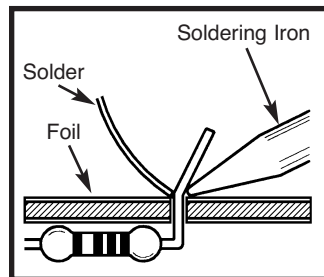

3. Allow the solder to flow around the connection. Then, remove the solder and the iron and let the connection cool. The solder should have flowed smoothly and not lump around the wire lead.

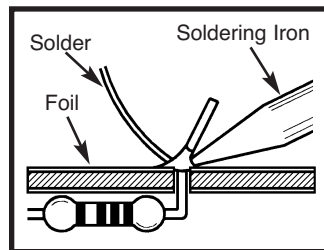

4. Here is what a good solder connection looks like.

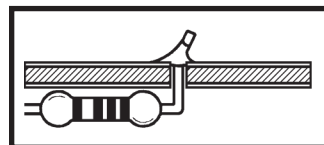

Types of Poor Soldering Connections

1. **Insufficient heat** - the solder will not flow onto the lead as shown.

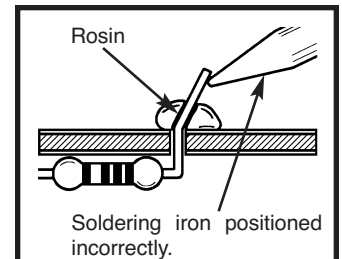

2. **Insufficient solder** - let the solder flow over the connection until it is covered. Use just enough solder to cover the connection.

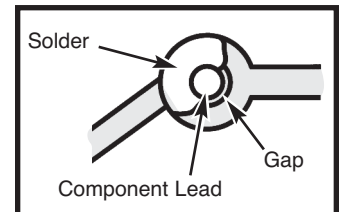

3. **Excessive solder** - could make connections that you did not intend to between adjacent foil areas or terminals.

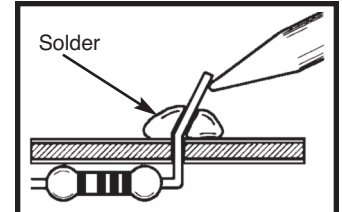

4. **Solder bridges** - occur when solder runs between circuit paths and creates a short circuit. This is usually caused by using too much solder. To correct this, simply drag your soldering iron across the solder bridge as shown.

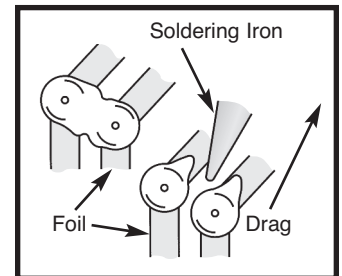

ASSEMBLE COMPONENTS TO THE PC BOARD

Care must be given to identifying the proper components and in good soldering habits. Refer to the soldering tips section in this manual before you begin installing the components. Place a check mark in the box after each step is complete.

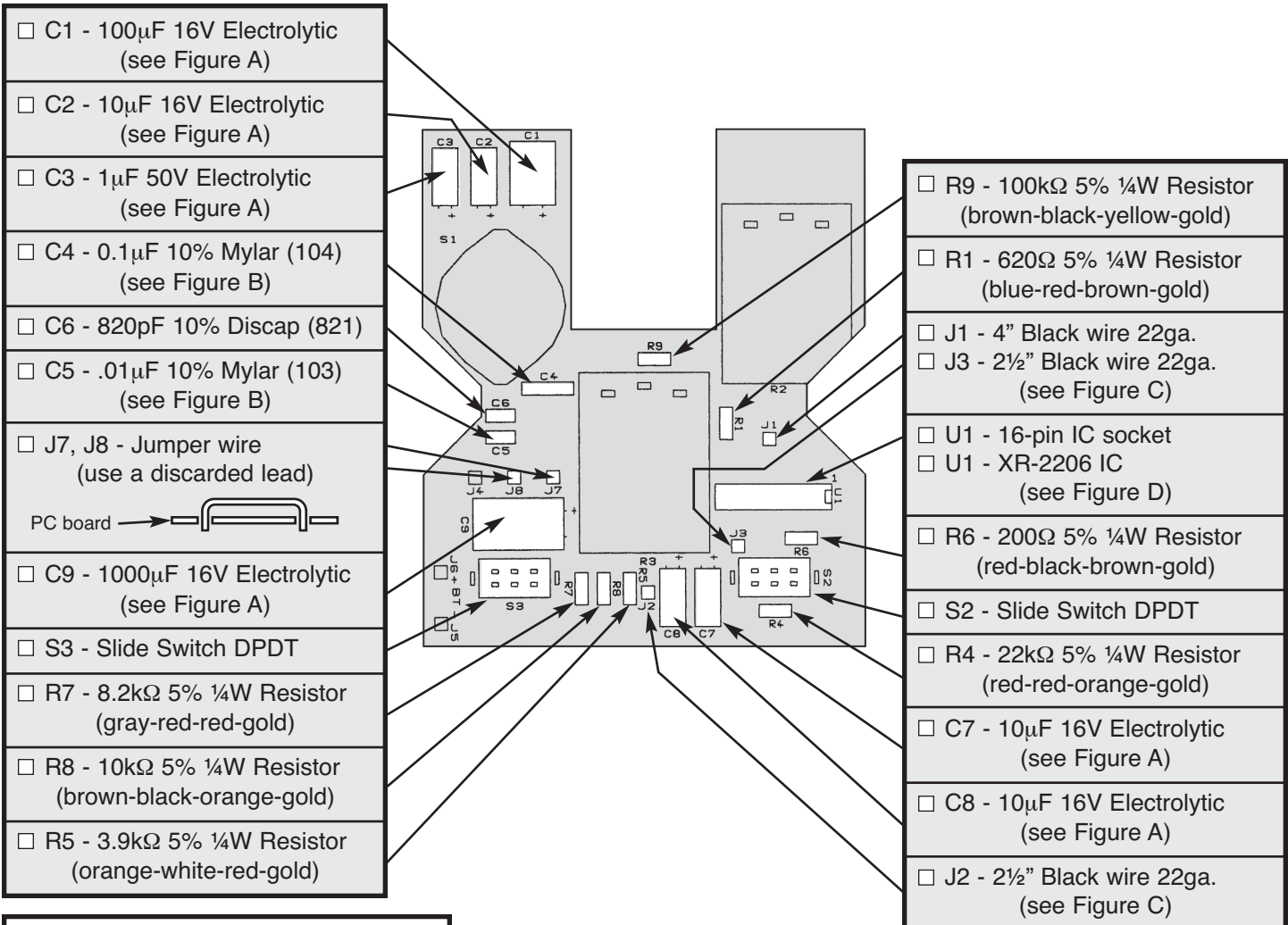

Figure A

Electrolytic capacitors have polarity. Be sure to mount them with the short negative (-) lead (marked on side) in the correct hole.

Warning: If the capacitor is connected with incorrect polarity, it may heat up and either leak or cause the capacitor to explode.

↓

Mount the electrolytics horizontal to the PC board. Bend the leads at right angles and then insert the leads into the PC board.

Figure B

Bend the capacitor over before soldering.

Figure C

Cut one 4" and two 2 1/2" wires and strip 1/4" of insulation off of both ends of the wires. Solder these wires to the points J1, J2, and J3.

Figure D

Insert the IC socket into the PC board with the notch in the direction shown on the top legend. Solder the IC socket into place. Insert the IC into the socket with the notch in the same direction as the notch on the socket.

ASSEMBLE COMPONENTS TO THE PC BOARD (continued)

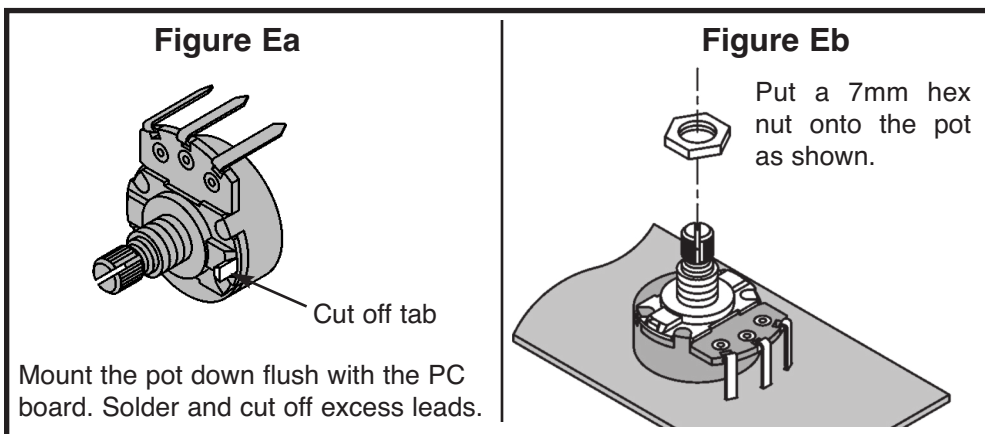
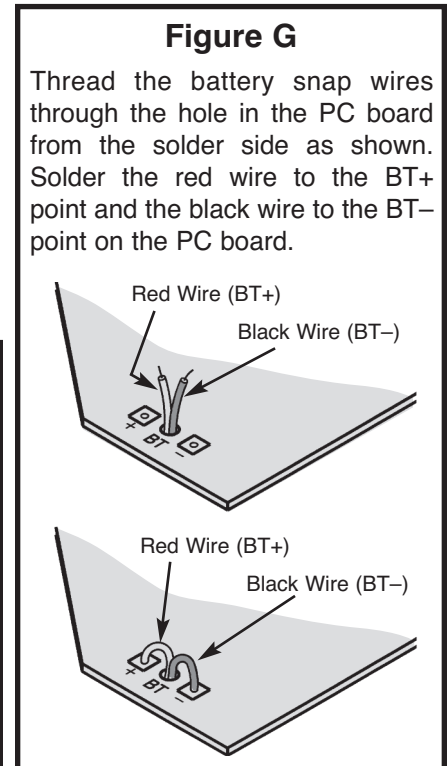
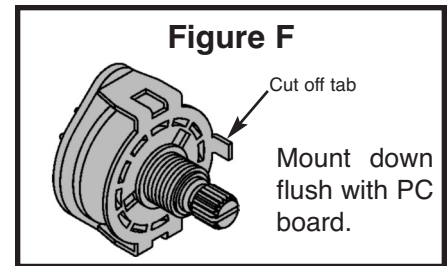
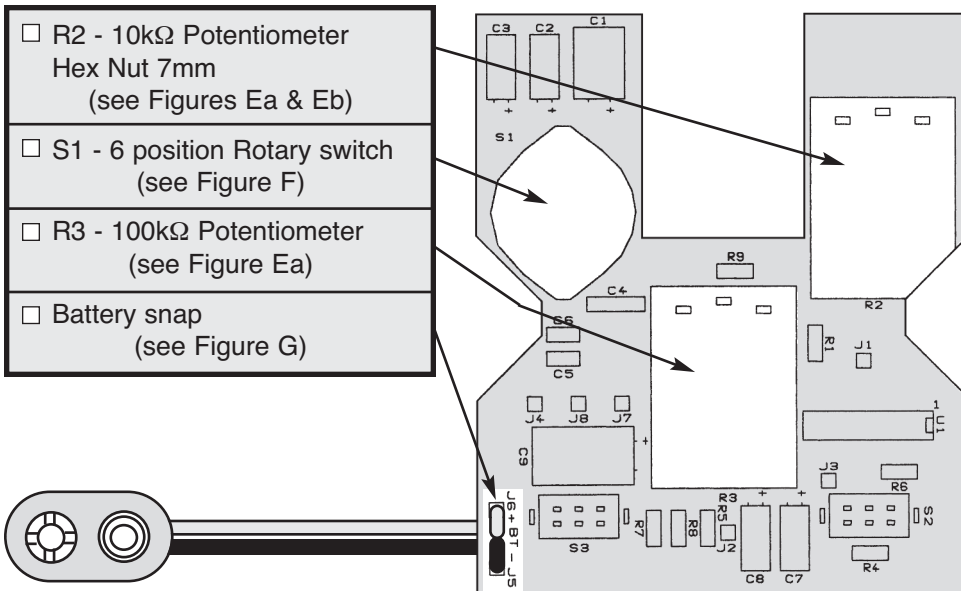

INSTALL COMPONENTS TO FRONT PANEL

- Peel the backing off of the front label and carefully adhere it to the top case, aligning the holes while doing so, as shown in Figure H.

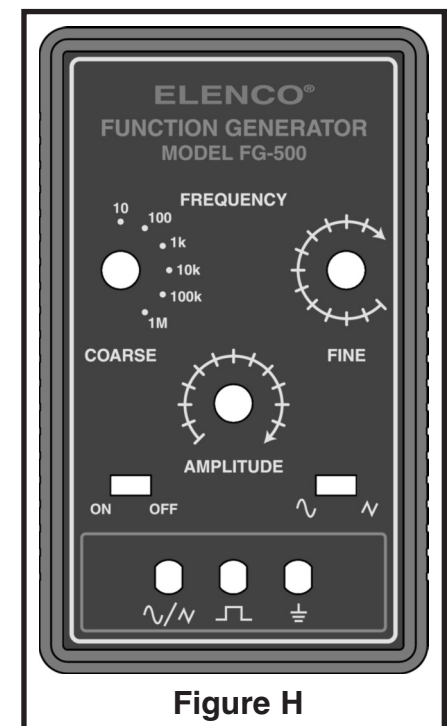

INSTALL COMPONENTS TO FRONT PANEL (continued)

- ❑ Install the colored binding posts to the panel as shown in Figure I. Use the hardware shown in the figure. Make sure that the small nuts are tight.

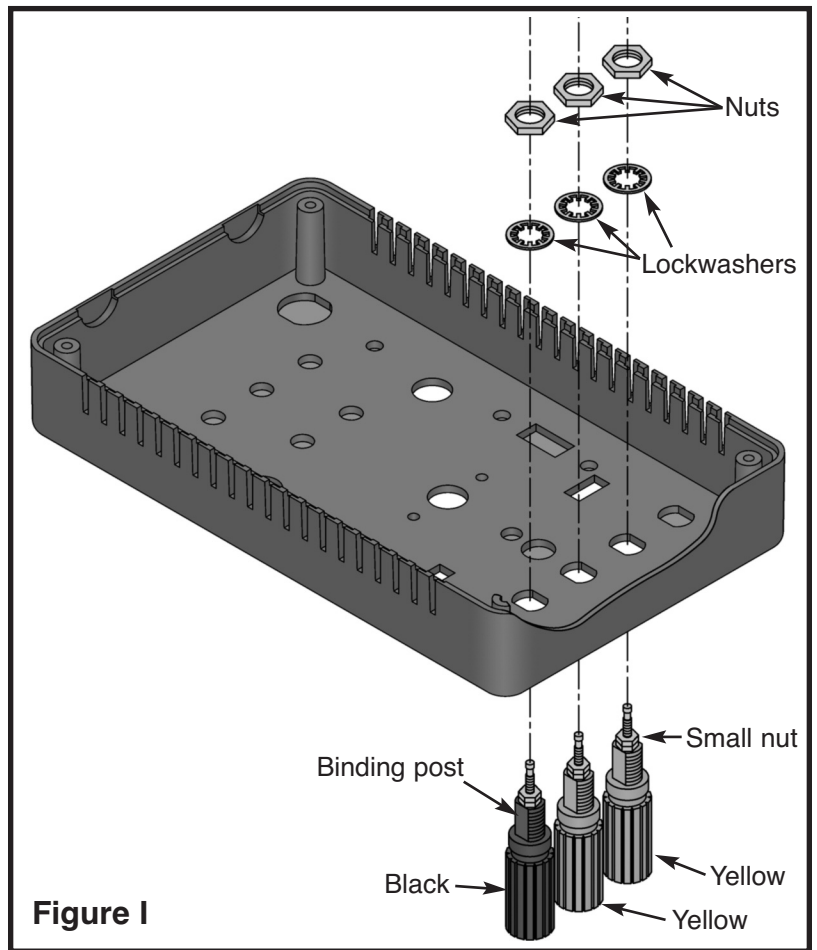

WIRING (See Figure J)

- ❑ Solder the wire from hole J1 on the PC board to the first yellow binding post as shown.
- ❑ Solder the wire from hole J2 on the PC board to the second yellow binding post as shown.
- ❑ Solder the wire from hole J3 on the PC board to the black binding post as shown.

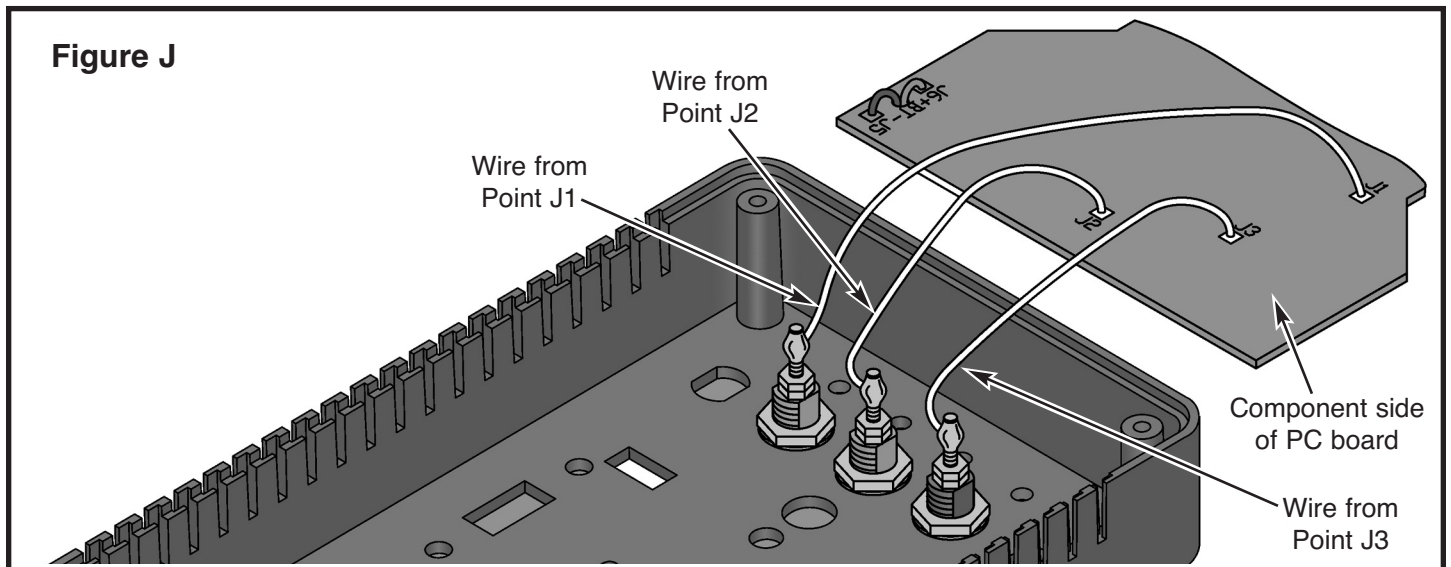

FINAL ASSEMBLY

- ❑ Fit the PC board assembly into the top case, making sure that all switches and pots come through the holes in the panel as shown in Figure K.
- ❑ Place the washers onto their locations as shown in Figure K, being careful to check the sizes. Then, tighten the hex nuts onto the potentiometers and rotary switch, noting their size as shown in Figure K.
- ❑ Peel off the protective backing on one side of the double-sided tape and adhere it to the bottom case in the location shown in Figure L.
- ❑ Peel off the remaining protective backing from the tape and adhere the battery holder to the tape, with the battery holder in the direction shown in Figure L.
- ❑ Obtain a 9 volt battery (alkaline preferred). Press the battery snap onto the battery terminals (see Figure L) and then mount the 9V battery onto the holder.

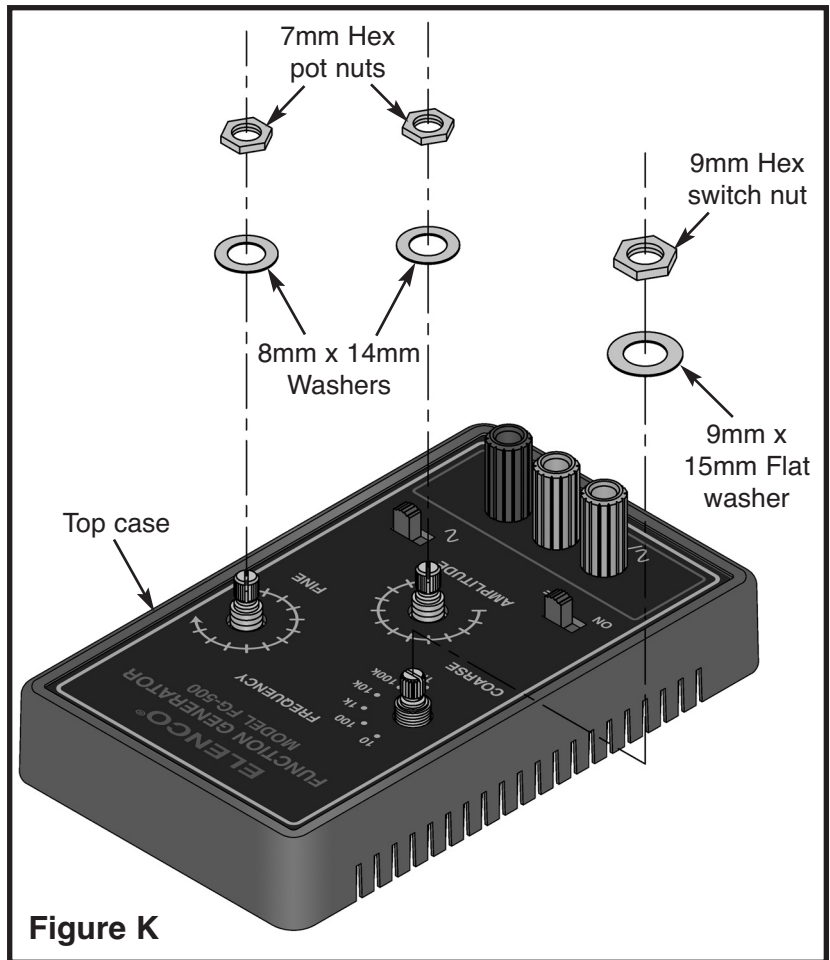
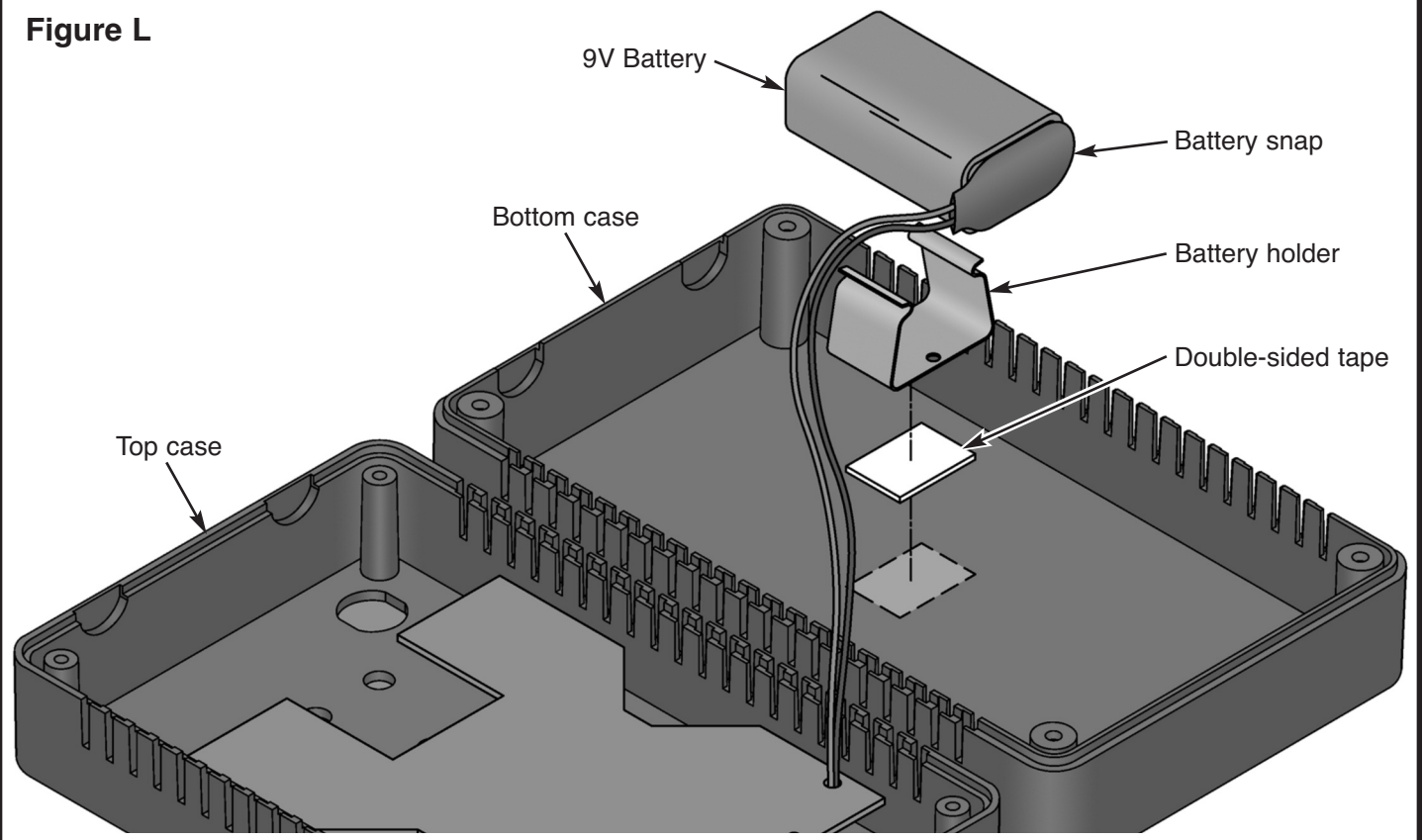

Figure K

Figure L



FINAL ASSEMBLY (continued)

- ❑ Remove the backing from each rubber foot and place them in the locations shown in Figure M.

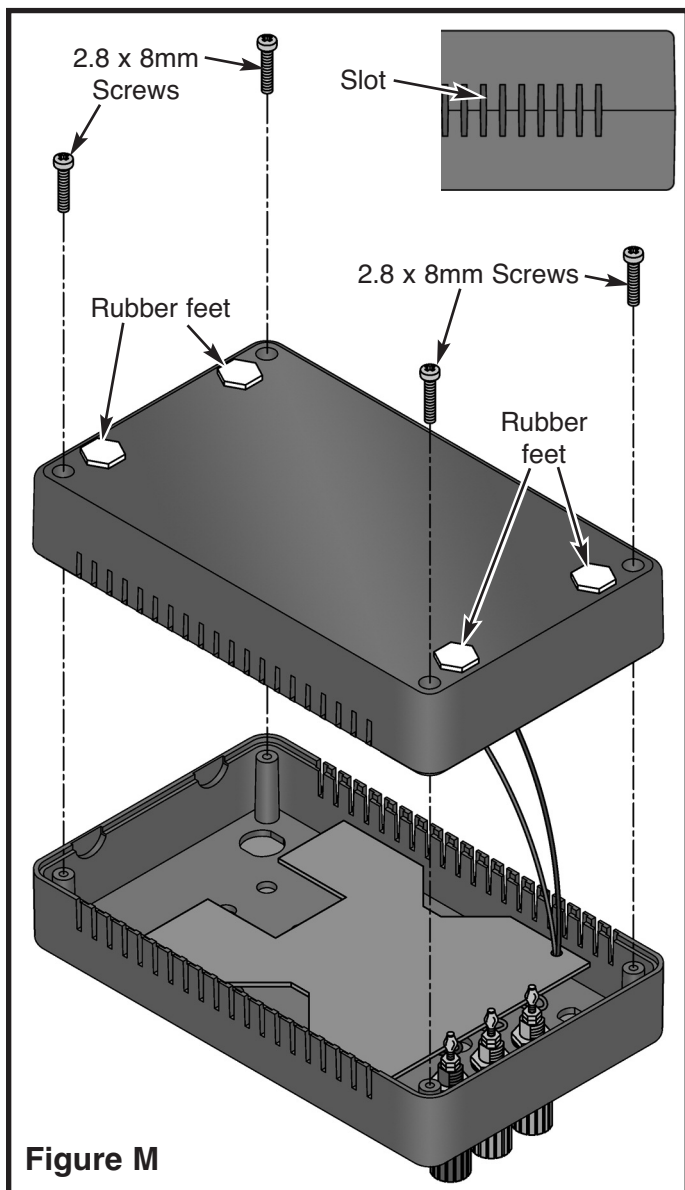

Figure M

- ❑ Assemble the top and bottom case sections and fasten with four 2.8 x 8mm self-tapping screws as shown in Figure M. Make sure the slots on the side line up with one another.
- ❑ Turn the shafts on the two potentiometers and rotary switch fully counter-clockwise. Push the three knobs onto the shafts so that the line on the knobs are on the points shown in Figure N.



Figure N

TESTING THE FG-500 FUNCTION GENERATOR

The unit may be tested by following the 4 steps listed below. Should any of these tests fail, refer to the Troubleshooting Guide.

1) SET THE SWITCHES AND POTS AS FOLLOWS:

| | |
|---------------|---|
| On/Off | On |
| Range | 10 |
| Frequency | Maximum (clockwise) |
| Amplitude | Maximum (clockwise) |
| Sine/Triangle | Set Sine/Triangle switch to Sine position |

In each of the following steps, start with the switch and pots as shown on the previous page.

2) OUTPUT WAVEFORMS

Connect an oscilloscope probe to the square wave output. You should see about 8V peak to peak square wave of a little over 15Hz. Connect the oscilloscope probe to the sine/triangle wave output. You should see a sine wave of approximately 3V peak to peak or greater. Set the Sine/Triangle switch to the Triangle wave position. You should see a triangle waveform of approximately 3V peak to peak or greater. In both sine and triangle waves, the frequency is also a little over 15Hz.

3) FREQUENCY CONTROLS

6 range settings, vary the FREQUENCY pot from max to min and check that the frequency varies according to Table 1 on page 12.

4) AMPLITUDE CONTROLS

Set the switch and pots as in Step 1. Connect the oscilloscope to the sine/triangle wave output and vary the AMPLITUDE pot. The sine wave amplitude should vary from near zero to approximately 3V peak to peak or greater.

TROUBLESHOOTING GUIDE

A) NO SINE/TRIANGLE OR SQUARE WAVE OUTPUT

- 1) Check the soldering on switch S3.
- 2) Check battery and battery snap.
- 3) Check the soldering on IC U1.
- 4) Check for +9V on IC1 pin 4.
- 5) Check that U1 is not installed backwards.
- 6) Check all of the values and soldering on R1, R2, R3, R4, R5, R7, R8, R9, C8, and C9.

B) WRONG FREQUENCY ON ANY RANGE SETTING

- 1) This indicates a wrong value capacitor in the bad range position.

C) SINE/TRIANGLE SWITCH DOESN'T WORK

- 1) Check the soldering on switch S2 and R6.
- 2) Check the value of R6.
- 3) Check pin 13 and 14 of U1.

D) AMPLITUDE CONTROL DOESN'T WORK

- 1) Check the soldering on R3, R7, R8, R4 and R9.
- 2) Check the values of the above mentioned components.

E) FREQUENCY CONTROL DOESN'T WORK

- 1) Check the soldering on R1 and R2.
- 2) Check the values of the above two resistors.

FOIL SIDE OF PC BOARD

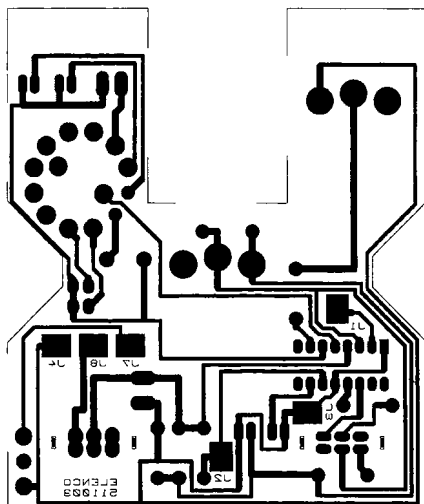

FUNCTIONAL DESCRIPTION

The FG-500 is a function generator integrated circuit capable of producing high quality sine, triangle, and square waves of high stability and accuracy. A picture of each waveform is shown below:

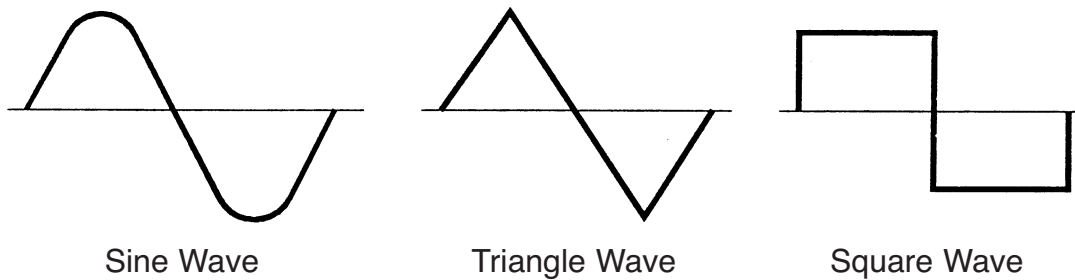

THEORY OF OPERATION

The heart of the FG-500 Function Generator is the XR-2206 monolithic function generator integrated circuit. The XR-2206 is comprised of four main functional blocks as shown in the functional block diagram (Figure 1). They are:

- A Voltage Controlled Oscillator (VCO)
- An Analog Multiplier and Sine-shaper
- Unity Gain Buffer Amplifier
- A set of current switches

The VCO actually produces an output frequency proportional to an input current, which is produced by a resistor from the timing terminals to ground. The current switches route one of the currents to the VCO to produce an output frequency. Which timing pin current is used, is controlled by the FSK input (pin 9). In the FG-500, the FSK input is left open, thus only the resistor on pin 7 is used. The frequency is determined by this formula:

$$f_o = 1/RC \text{ Hz}$$

where f_o is the frequency in Hertz
 R is the resistance at pin 7 in Ohms
 C is the capacitance across pin 5 and 6 in Farads

Note that frequency is inversely proportional to the value of RC. That is, the higher the value of RC, the smaller the frequency.

The resistance between pins 13 and 14 determine the shape of the output wave on pin 2. No resistor produces a triangle wave. A 200Ω resistor produces a sine wave.

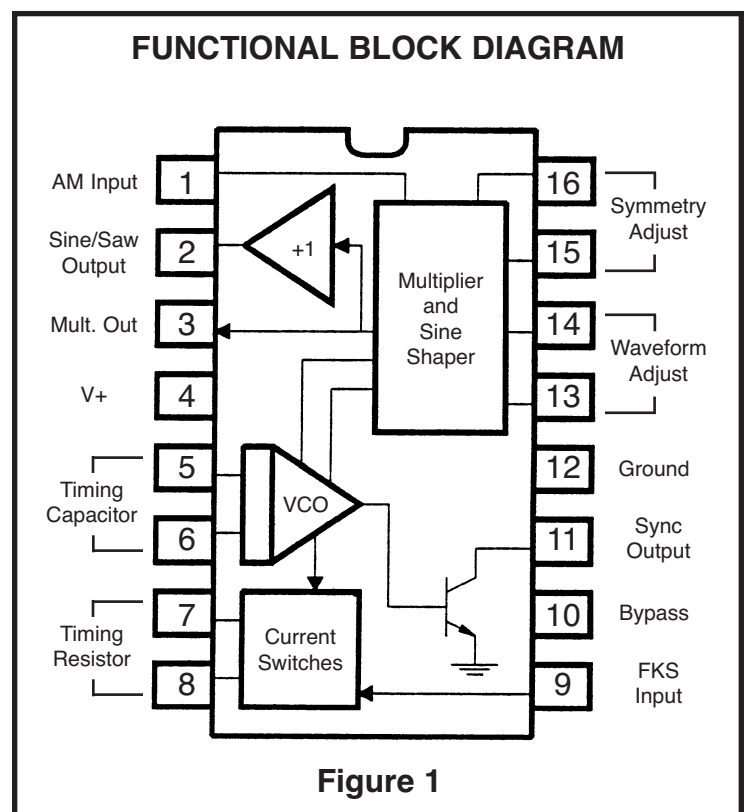

Figure 1

CONTROLS

RANGE SWITCHES

Six ranges of frequency are provided by the range switch as shown in Table 1.

| POSITION | TYPICAL FREQUENCY RANGE |
|----------|-------------------------|
| 1 | 1Hz - 15Hz |
| 2 | 10Hz - 150Hz |
| 3 | 100Hz - 1.5kHz |
| 4 | 1kHz - 15kHz |
| 5 | 10kHz - 150kHz |
| 6 | 100kHz - 1MHz |

Table 1

SINE/TRIANGLE SWITCH

This SINE/TRIANGLE Switch selects the waveform, sine wave or triangle wave, sent to the SINE/TRIANGLE output terminal.

FREQUENCY MULTIPLIER

The multiplier is a variable control allowing frequency settings between fixed ranges. The ranges are as shown in Table 1.

AMPLITUDE CONTROL

The Amplitude Control provides amplitude adjustment from near 0 to 3V or greater for both sine and triangle waveforms.

ON/OFF SWITCH

The ON/OFF Switch turns the power to the FG-500 on or off.

OUTPUT TERMINAL

The output marked SINE/TRIANGLE provides the sine and triangle waveforms. The output marked SQUARE WAVE provides the square wave. The output marked GND provides the ground for all output waveforms.

QUIZ (answers on bottom of following page)

- 1) The heart of the FG-500 Function Generator is the _____ monolithic function generator integrated circuit.
- 2) The XR-2206 is comprised of four main blocks. They are _____, _____, _____, and _____.
- 3) The VCO actually produces an output frequency proportional to an input _____.
- 4) The current switches route one of the currents to the VCO to produce an output _____.
- 5) The frequency is determined by the formula _____.
- 6) Frequency is inversely proportional to the value of _____.
- 7) The resistance between pins 13 and 14 determine the shape of the _____ wave on pin 2.
- 8) No resistor produces a _____ wave.
- 9) A 200 Ω resistor produces a _____ wave.
- 10) The six ranges of frequency provided by the range switch are:
_____ to _____.
_____ to _____.
_____ to _____.
_____ to _____.
_____ to _____.
_____ to _____.

SCHEMATIC DIAGRAM

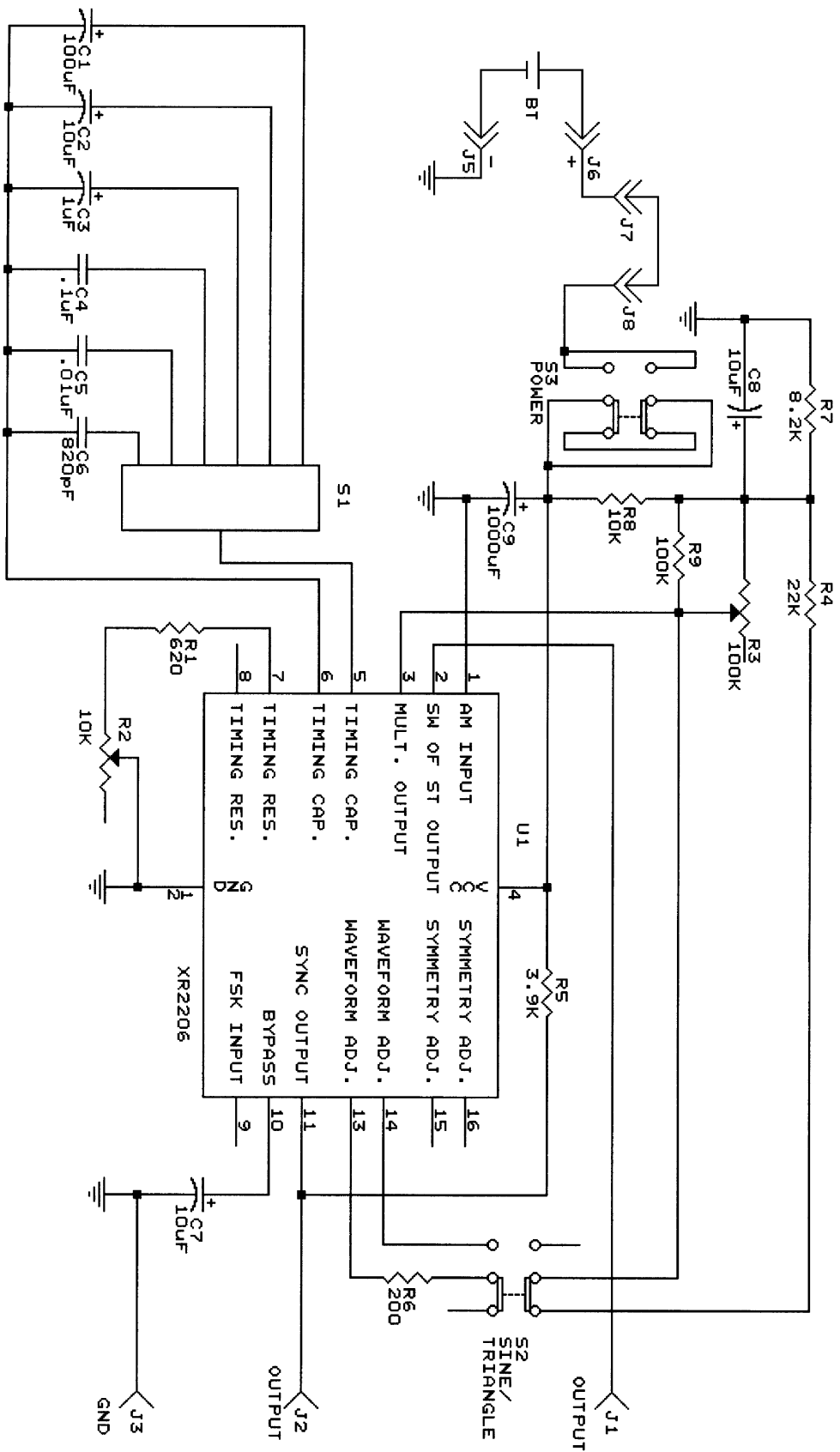

Answers: 1) XR-2206; 2) A Voltage Controlled Oscillator, An Analog Multiplier and Sine Shaper, Unity Gain Buffer Amplifier and A Set of Current Switches; 3) Current; 4) Frequency; 5) 1/R_C; 6) RC; 7) output; 8) triangle; 9) sine; 10) 1Hz to 15Hz, 10Hz to 150Hz, 100Hz to 1.5kHz, 1kHz - 15kHz, 10kHz - 150kHz, 100kHz - 1MHz.

EDUCATION KITS

Complete with PC Board and Instruction Book

| | | | |
|---|---|---|---|
| <p>Space War Gun K-10</p> <p>Rapid fire or single shot with 2 flashing LEDs.</p>  <p>Requires 9V battery</p> | <p>0-15V Power Supply K-11</p> <p>A low-cost way to supply voltage to electronic games, etc.</p>  <p>0-15VDC @ 300mA</p> | <p>Christmas Tree K-14</p> <p>Produces flashing colored LEDs and three popular Christmas melodies.</p>  <p>Requires 9V battery</p> | <p>LED Robot Blinker K-17</p> <p>You'll have fun displaying the PC board robot. Learn about free-running oscillators.</p>  <p>Requires 9V battery</p> |
| <p>Digital Bird K-19</p> <p>You probably have never heard a bird sing this way before.</p>  <p>Requires 9V battery</p> | <p>Burglar Alarm K-23</p> <p>Alarm for your car, house, room, or closet.</p>  <p>Requires 9V battery</p> | <p>Metal Detector K-26</p> <p>Find new money and old treasure. Get started in this fascinating hobby.</p>  <p>Requires 9V battery</p> | <p>Pocket Dice K-28</p> <p>To be used with any game of chance.</p>  <p>Requires 9V battery</p> |
| <p>FM Microphone AK-710/K-30</p> <p>Learn about microphones, audio amplifiers, and RF oscillators. Range up to 100 feet.</p>  <p>Requires 2 "AA" batteries</p> <p>Training course incl.</p> | <p>Telephone Bug K-35</p> <p>Our bug is only the size of a quarter, yet transmits both sides of a telephone conversation to any FM radio.</p>  <p>No batteries required!</p> | <p>Sound Activated Switch K-36</p> <p>Clap and the light comes on . . . clap again and it goes off.</p>  <p>Requires 9V battery</p> | <p>Solder Practice Kit AK-100/SP-1A</p> <p>You will achieve good soldering techniques while building a European siren.</p>  <p>Requires 9V battery</p> |
| <p>Two IC AM Radio AM-780K</p> <p>New design - easy-to-build, complete radio on a single PC board. Requires 9V battery.</p>  | <p>Auto-scan FM Radio Kit FM-88K</p> <p>Unique design - two-IC FM receiver with training course.</p>  <p>Requires 9V battery</p> | <p>Transistor Tester DT-100K</p> <p>Test in-circuit transistors and diodes.</p>  <p>Requires 9V battery</p> | <p>0-15VDC Variable Voltage DC Power Supply Kit XP-15K</p> <p>Ideal for students, technicians, and hobbyists. Great for breadboarding.</p>  |
| <p>AM Radio Kit (combo transistor and IC) AM-550CK</p> <p>The AM-550CK Radio is a "superheterodyne" receiver of the standard AM (amplitude modulated) broadcast frequencies.</p>  <p>Requires 9V battery</p> | <p>AM/FM Radio Kit (combo transistor and IC) AMFM-108CK</p> <p>The AMFM-108CK Radio is a "superheterodyne" receiver of the standard AM (amplitude modulated) and FM (frequency modulated) broadcast frequencies.</p>  <p>Requires 9V battery</p> | | |

ELENCO®

150 Carpenter Avenue

Wheeling, IL 60090

(847) 541-3800

Website: www.elenco.com

e-mail: elenco@elenco.com