



# Wirelink plus



The Wirelink plus is the non-indicating version of Straightpoint's very popular Radiolink plus and Loadlink plus digital dynamometer tension load cells. This non-indicating Loadlink is designed for use with Straightpoint's Handheld plus digital display, desktop controller PC software (DCP10M) or other form of instrumentation.

Manufactured from aerospace grade aluminium, utilising an advanced internal design structure, this range of non-indicating load cells are extremely lightweight, easy to handle and are used worldwide in an array of industries for lifting, pulling, proof and structural load testing.

The extremely versatile platform can be used with digital displays, including the Straightpoint Handheld plus, PLCs, data acquisition systems (DAQ) etc. They are configured with a vast array of output formats to include mV/V, RS-422, RS-485, utilising the ASCII, MODBUS TRU and CAN-BUS protocols.

A standard analogue output option is available to include:

- 3 wire 0-10v
- 3 wire 0-5v
- 4 wire +/-10v
- 3 wire 4-20mA
- 2 wire 4-20mA

The Wirelink plus is supplied with a 10-metre cable as standard, however, usable cable length varies greatly with lengths available to 1,500 metres depending on output format.

## Features and benefits:

- Constructed of lightweight aluminium
- Available in capacities ranging from 1 to 300 tonnes
- High accuracy
- Multiple output options to include mV/V, analogue out, ASCII, MODBUS RTU and CAN-BUS
- Available with IP68 environmental protection
- Options for subsea use available
- 2-year warranty
- DNV-GL Type Approval
- Complies with ASME B30.26

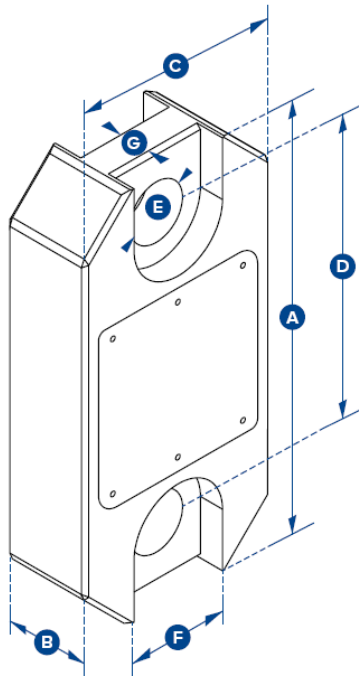

Part Numbers													
SP	WLP1T	WLP2T5	WLP6T5	WLP12T	WLP25T	WLP35T	WLP55T	WLP75T	WLP100T	WLP150T	WLP200T	WLP250T	WLP300T
Crosby	2789154	2789158	2789273	2789162	2789167	2789160	2789269	2789161	2789151	2789163	2789165	2789156	2789159
Capacity	1,000kg 2200lb	2.5te 5500lb	6.5te 14300lb	12te 26000lb	25te 55000lb	35te 77000lb	55te 120000lb	75te 165000lb	100te 220000lb	150te 330000lb	200te 440000lb	250te 550000lb	300te 660000lb
Resolution	0.5kg 1lb	0.001te 2lb	0.001te 2lb	0.002te 5lb	0.005te 10lb	0.005te 10lb	0.01te 20lb	0.01te 20lb	0.05te 100lb	0.05te 100lb	0.1te 200lb	0.1te 200lb	0.1te 200lb
Units	kg lb	te lb	te lb	te lb	te lb	te lb	te lb	te lb	te lb	te lb	te lb	te lb	te lb
Weight	1.5kg 3.3lb	1.5kg 3.3lb	2.4kg 5.3lb	3.7kg 8.2lb	5kg 11lb	8.6kg 19lb	13kg 28.7lb	16kg 35.3lb	34kg 75lb	46kg 101.4lb	82kg 180.8lb	82kg 180.8lb	118kg 260lb
Safety Factor	12:1	7:1	7:1	7:1	5:1	5:1	5:1	5:1	5:1	4:1	5:1	4:1	5:1
Operating Temp	-10°C to +50°C or 14°F to 122°F												
Accuracy	±0.1% of full scale												
Protection	IP67 or NEMA6												
Dimension A	204 8.03"	204 8.03"	249 9.80"	305 12.01"	340 13.39"	393 15.47"	424 16.69"	470 18.50"	608 23.94"	670 26.38"	700 27.56"	700 27.56"	806 31.73"
Dimension B	43 1.69"	43 1.69"	43 1.69"	47 1.85"	60 2.36"	75 2.95"	75 2.95"	75 2.95"	99 3.90"	99 3.90"	144 5.67"	144 5.67"	150 5.91"
Dimension C	104 4.09"	104 4.09"	113 4.45"	113 4.45"	115 4.53"	126 4.96"	180 7.09"	202 7.95"	255 10.04"	303 11.93"	350 13.78"	350 13.78"	426 16.77"
Dimension D	146 5.75"	146 5.75"	165 6.50"	193 7.60"	215 8.46"	225 8.86"	230 9.06"	260 10.24"	320 12.60"	360 14.17"	350 13.78"	350 13.78"	350 13.78"
Dimension ØE	24.5 0.96"	24.5 0.96"	38 1.50"	47.5 1.87"	55 2.17"	60 2.36"	76 2.99"	76 2.99"	109 4.29"	109 4.29"	145 5.71"	145 5.71"	160 6.30"
Dimension F	48 1.89"	48 1.89"	66 2.60"	Not relevant in this capacity									
Dimension G	19 0.75"	19 0.75"	32 1.26"										
Crosby Shackle	G2130						G2140						
Loading Pin Ø	19 3/4"	19 3/4"	25 1"	35 1 3/8"	51 2"	57 2 1/4"	57 2 1/4"	70 2 3/4"	83 3 1/4"	95 3 3/4"	121 4 3/4"	127 5"	152 6"

Options					
Part N° SP Crosby	ICA1 2789220	ICA2 2789221	ICA3 2789222	ICA4 2789223	ICA5 2789224
Description	3 wire 0-10v analogue output	3 wire 0-5v analogue output	4 wire ±10v analogue output	3 wire 4-20mA analogue output	2 wire 4-20mA analogue output